

# RADIO CRAFT

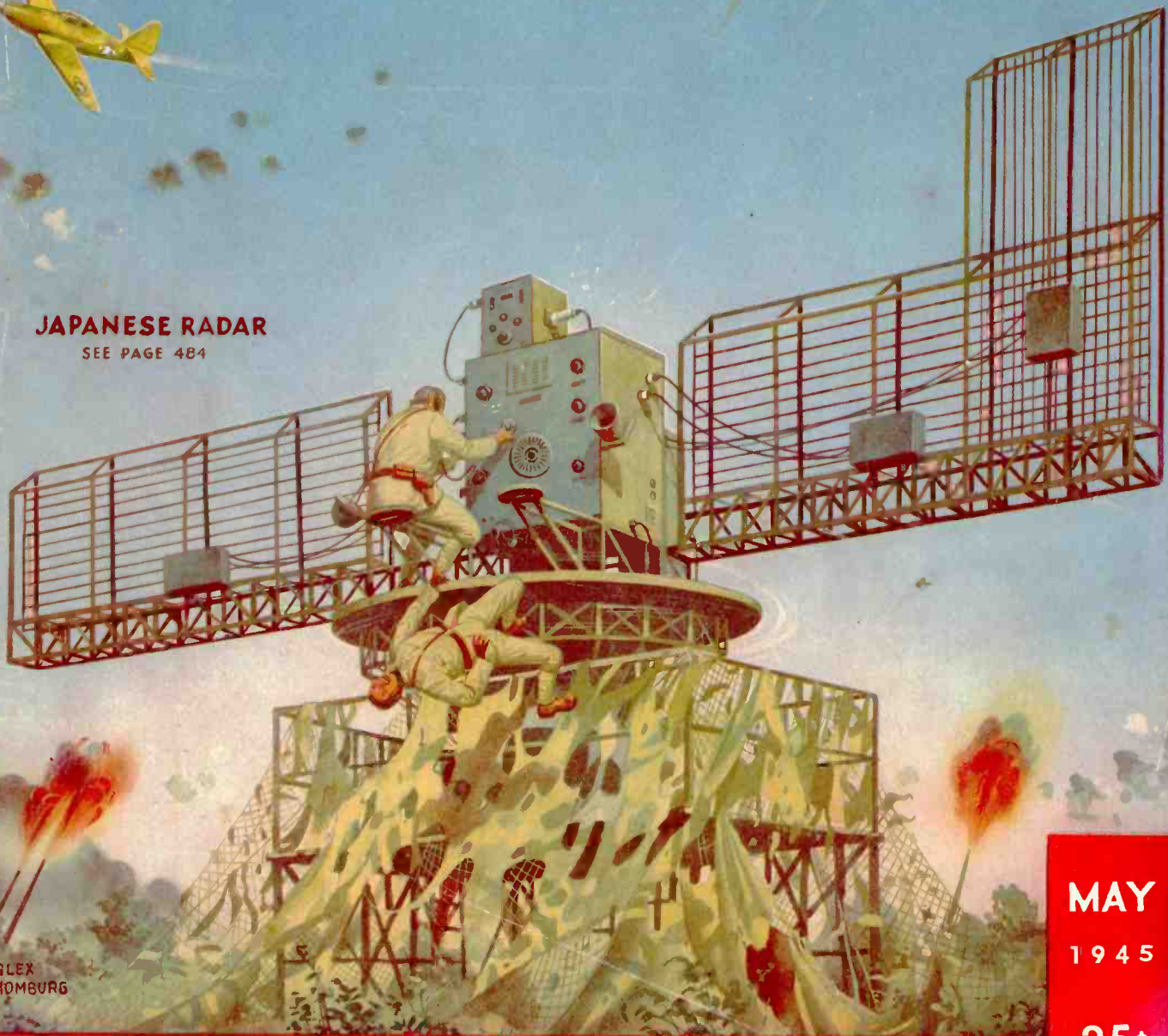

JAPANESE RADAR

SEE PAGE 484



ALEX  
SCHOMBURG

MAY

1945

25¢

CANADA 30¢

RADIO-ELECTRONICS IN ALL ITS PHASES

**CLEVELAND YELLOW CAB COMPANY  
Uses RAYTHEON TUBES  
in world's first taxicabs with two-way radio!**

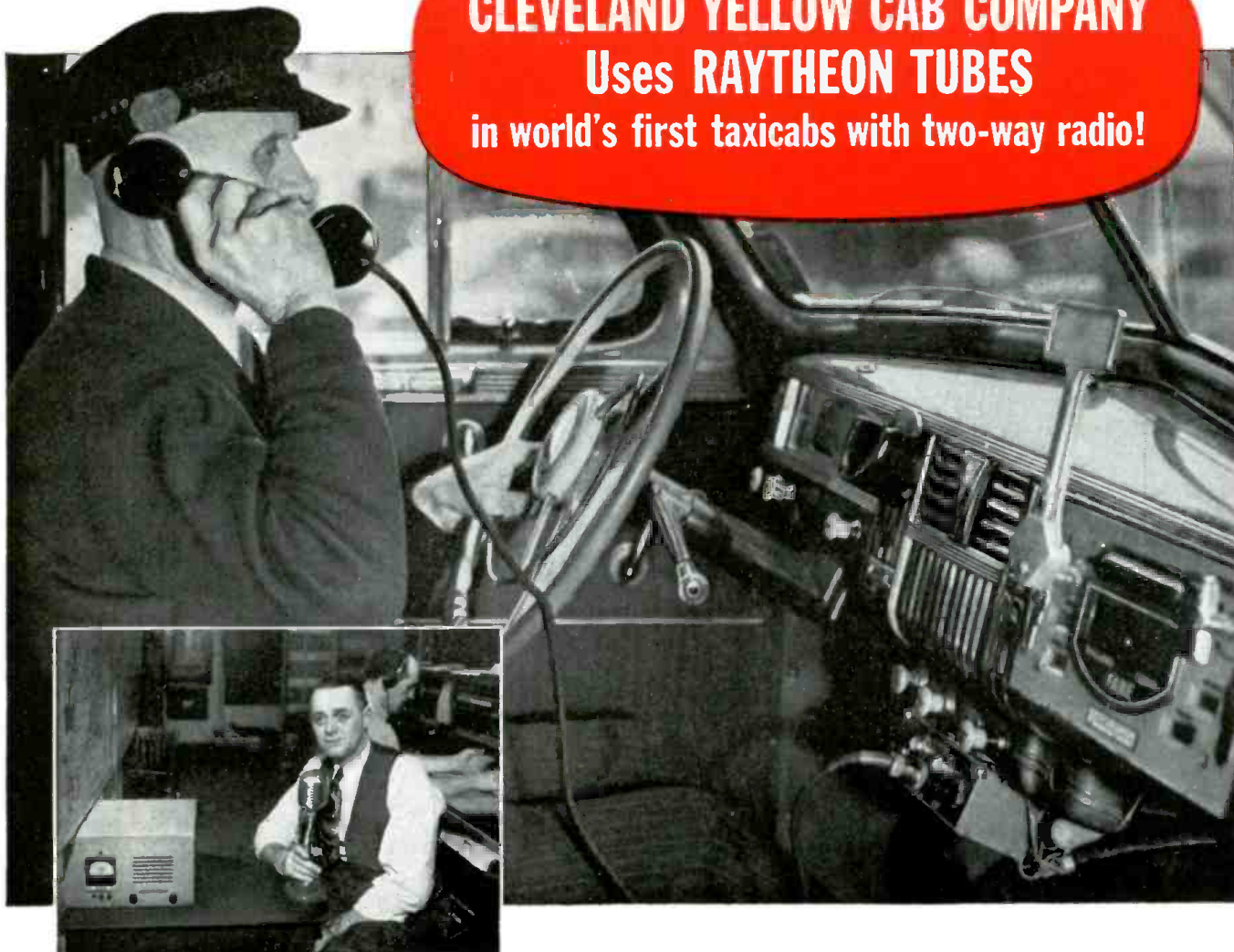

The eyes of the nation's transportation industry are on Cleveland these days, for it is there that the world's first taxicabs equipped with two-way radio are being demonstrated by the Cleveland Yellow Cab Company.

Officials say that dispatching has proved so much more efficient that future fleets similarly equipped will eliminate millions of miles of wasteful "dead" cruising. And they also report that Raytheon High-Fidelity Tubes, used in both transmitter and receivers, provide clear, dependable reception—even in the tunnels under Cleveland's Terminal Tower.

This application of Raytheon Tubes is just one of many being planned for the postwar period by progressive manufacturers in the electronics field.

If you are a radio service dealer, you, too, should realize that Raytheon's combined pre-war and wartime tube experience will result in even *better* tubes for all uses. Keep an eye on Raytheon . . . and watch for a Raytheon merchandising program that will help you be more successful, in the peacetime years ahead, than you've ever been before!

*Increased turnover and profits . . . easier stock control . . . better tubes at lower inventory cost . . . these are benefits which you may enjoy as a result of the Raytheon standardized tube type program, which is part of our continued planning for the future.*

**Raytheon  
Manufacturing Company**  
RADIO RECEIVING TUBE DIVISION  
Newton, Massachusetts — Los Angeles  
New York — Chicago — Atlanta



**RAYTHEON**  
*High Fidelity*  
**ELECTRONIC AND RADIO TUBES**

**DEVOTED TO RESEARCH AND THE MANUFACTURE OF TUBES FOR THE NEW ERA OF ELECTRONICS**

# I WILL TRAIN YOU TO START A SPARE TIME OR FULL TIME RADIO SERVICE BUSINESS WITHOUT CAPITAL

J. E. SMITH,  
PRESIDENT  
National Radio  
Institute  
31st Year of  
Training Men  
for Success  
in Radio



## You Build These and Many Other Radio Circuits with 6 Kits of Parts I Supply

By the time you've conducted 60 sets of Experiments with Radio Parts I supply, made hundreds of measurements and adjustments, you'll have valuable PRACTICAL Radio experience for a good full or part-time Radio job!

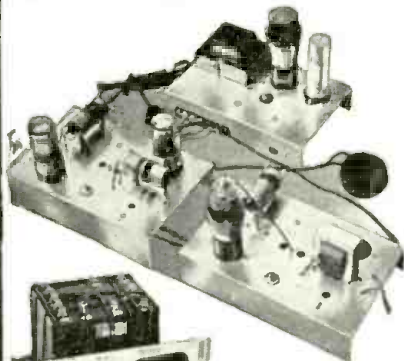

You build MEASURING INSTRUMENT above early in Course, useful for Radio work to pick up EXTRA spare time money. It is a vacuum tube multimeter, measures A.C., D.C., R.F. volts, D.C. currents, resistance, receiver output.

You build the SUPERHETERODYNE CIRCUIT above, containing a preselector oscillator-mixer-first detector, i.f. stage, diode-detector-a.v.c. stage and audio stage. It will bring in local and distant stations. Get the thrill of learning at home evenings in spare time while you put the set through fascinating tests!



Building the A. M. SIGNAL GENERATOR at right will give you valuable experience. Provides amplitude-modulated signals for test and experimental purposes.

The men at the right are just a few of many I have trained, at home in their spare time, to be Radio Technicians. They are now operating their own successful spare time or full time Radio businesses. Hundreds of other men I trained are holding good jobs in practically every branch of Radio, as Radio Technicians or Operators. Doesn't this PROVE that my "50-50 Method" of training can give you, in your spare time at home, BOTH a thorough knowledge of Radio principles and the PRACTICAL experience you need to help you make more money in the fast-growing Radio industry?

Let me send you facts about rich opportunities in the busy Radio field. See how knowing Radio can give you security, a prosperous future . . . lead to jobs coming in Television and Electronics. Send the coupon NOW for FREE 64-page illustrated book, "Win Rich Rewards in Radio." Read how N.R.I. trains you at home in spare time. Read how you practice building, testing, repairing Radios with SIX BIG KITS of Radio parts I send as part of your Course.

### Future for Trained Men Is Bright In Radio, Television, Electronics

The Radio Repair business is booming NOW. There is good money fixing Radios in your spare time or own full time business. And trained Radio Technicians also find wide-open opportunities in Police, Aviation and Marine Radio, in Broadcasting, Radio Manufacturing, Public Address work, etc. Send for free book which pictures your present and future opportunities.

Think of the boom coming when new Radios can be made! Think of the backlog of business built up in all branches of Radio! And think of even greater opportunities when Television, FM, Electronics, can be offered to the public! Use only a few hours of your spare time each week to get into Radio NOW. You may never again see the time when it will be so easy and profitable to get started. Mail coupon for complete information.

### Many Beginners Soon Make \$5, \$10 a Week EXTRA in Spare Time

The day you enroll I start sending EXTRA MONEY JOB SHEETS to help you make EXTRA money fixing Radios in spare time while learning. You LEARN Radio principles from my easy-to-grasp Lessons—PRACTICE what you learn by building real Radio Circuits with the six kits of Radio parts I send—USE your knowledge to make extra money while getting ready for a good full time Radio job.

### Find Out What N.R.I. Can Do for YOU

MAIL THE COUPON for your FREE copy of my 64-page book. It's packed with facts about opportunities for you. Read the details about my Course. See the fascinating jobs Radio offers. See how you can train at home. Read letters from men I trained, telling what they are doing, earning. No obligation. Just MAIL COUPON in an envelope or paste it on a penny postal. J. E. Smith, President, Dept. 5EX, National Radio Institute, Pioneer Home Study Radio School, Washington 9, D. C.

### I Trained These Men

### SPARE TIME RADIO BUSINESS



"I have a spare time Radio and Electrical business of my own which has been very profitable, due to the efficient training I received from your Course. Last year I averaged over \$50 a month." —FRED H. GRIFFIE, Route 3, Newville, Pa.

"I am doing radio work in my spare time, and find it a profitable hobby. My extra earnings run about \$10 a week. I certainly am glad I took your N.R.I. Course." —FERDINAND ZIRBEL, Chase-ley, North Dakota.



"About six months after I enrolled I started making extra money in radio. I am a farmer and just work on radios evenings and stormy days. That brought me a profit of \$600 in the last year." —BENNIE L. ARENDS, RFD 2, Alexander, Iowa.

### I Trained These Men

### FULL TIME RADIO BUSINESS



"Not long ago I was working 16 hours a day in a filling station at \$10 a week. Now I have my own radio business and average over \$60 a week. The N.R.I. course is fine." —ALBERT C. CHRISTENSEN, 110-10th Avenue, Sidney, Neb.

"I am now operating a radio shop for myself and own all my equipment. Right now I only repair radios, because there are none to sell, but I average \$250 a month." —J. M. SCRIVENER, JR., Aberdeen, Miss.



"Am making over \$50 a week profit from my own shop. Have another N.R.I. man working for me. I like to hire N.R.I. men because they know radio." —NORMAN MILLER, Hebron, Neb.

## SAMPLE LESSON FREE

I will send you a FREE Lesson, "Getting Acquainted With Receiver Servicing," to show you how practical it is to train for Radio at home in spare time. It's a valuable lesson. Study it—keep it—use it—without obligation! Tells how Superheterodyne Circuits work, gives hints on Receiver Servicing, Locating Defects, Repair of Loudspeaker, I.F. Transformer, Gang Tuning Condenser, etc. 31 Illustrations.



My Radio Course Includes  
**TELEVISION • ELECTRONICS  
FREQUENCY MODULATION**

## GOOD FOR BOTH 64 PAGE BOOK SAMPLE LESSON FREE

J. E. SMITH, President, Dept. 5EX  
National Radio Institute, Washington 9, D. C.

Without obligating me, mail your Sample Lesson and 64-page book, FREE. I am particularly interested in the branch of Radio checked below. (No salesman will call. Please write plainly.)

- |   |  |
|---|--|
| <input type="checkbox"/> Radio Service Business of My Own                   | <input type="checkbox"/> Aviation Radio                  |
| <input type="checkbox"/> Service Technicians for Radio Stores and Factories | <input type="checkbox"/> Operating Broadcasting Stations |
| <input type="checkbox"/> Spare Time Radio Servicing                         | <input type="checkbox"/> Army, Navy Radio Jobs           |
| <input type="checkbox"/> Government Civilian Radio                          | <input type="checkbox"/> Operating Police Radio Stations |
|   | <input type="checkbox"/> Operating Ship and Harbor Radio |

(If you have not decided which branch you prefer—mail coupon for facts to help you decide.)

Name ..... Age .....

Address .....

City ..... Zone ..... State ..... 4FR



**CL**  
★ LAPEL ★  
Crystal Microphone

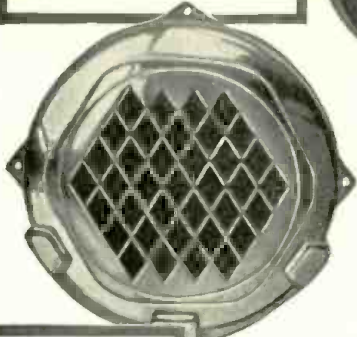

**AG**  
Crystal Microphone  
Public Address

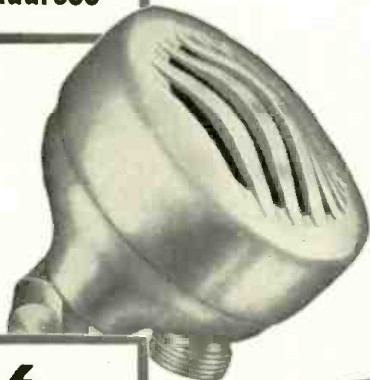

**C6**  
Crystal Microphone  
Public Address



**C7**  
Crystal Microphone  
Public Address

**RC**  
Home Recorder  
Crystal Microphone

# THINK ★ *American*

when you begin to utilize the conversions of military perfected voice transmission and electronic circuits that will be prevalent in the immediate post war period. Check the advantage of American Microphone quality. It is discernable . . . it always is.



**JOBBERS**  
Get your name on the list now, to receive important announcements American will make when the war time job is done.

*American* **MICROPHONE CO.**  
1915 So. Western Avenue, Los Angeles 7, California

*Here is the one quick practical way to*

# REALLY LEARN RADIO • ELECTRONICS and TELEVISION

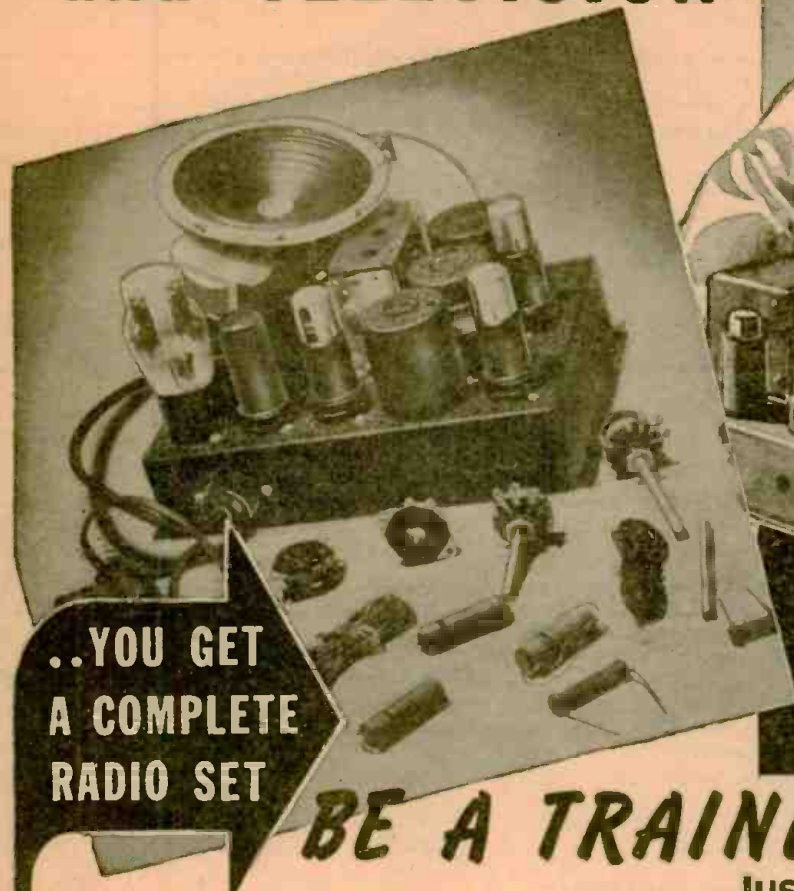

**..YOU GET  
A COMPLETE  
RADIO SET**

**SPRAYBERRY RADIO TRAINING**

*Gives you Both*



## BE A TRAINED TECHNICIAN

There's only one right way to learn Radio Electronics. You must get it through simplified lesson study combined with actual "shop" practice under the personal guidance of a qualified Radio Teacher. It's exactly this way that Sprayberry trains you . . . supplying real Radio parts for learn-by-doing experience right at home. Thus, you learn faster, your understanding is clear-cut, you acquire the practical "know how" essential to a good-paying Radio job or a Radio business of your own.

### A Bright Future

Now's the right time to start training. Because Radio is surging forward, expanding at a rapid pace . . . with the promise of spectacular opportunities in Television, Frequency Modulation, Industrial Electronics . . . in the vast Radio Service and Repair business. When you train with Sprayberry, you need no previous experience. The Course starts right at the beginning of Radio, even shows you how to make spare time profits while learning.

### I'll Show You a New, Fast Way to Test Radio Sets without Mfg. Equipment

The very same Radio parts I supply with your Course for gaining pre-experience in Radio work may be adapted through an exclusive Sprayberry wiring procedure to serve for complete, fast, accurate Radio Receiver trouble-shooting. Thus, you do not have one cent of outlay for manufactured Test Equipment, which is not only expensive but scarce. In every respect, my training is practical, complete . . . tested and proved for results. It will give you the broad, fundamental principles so necessary as a background, no matter which branch of Radio you wish to specialize in.

**JUST OUT! FREE!**

**HOW TO READ RADIO DIAGRAMS  
AND SYMBOLS**

. . . a valuable new book which explains in simple, non-technical English how to read and understand any Radio Set Diagram. Provides the quick key to analyzing any Radio circuit. Includes translations of all Radio symbols. Send for this FREE book now while supply lasts and along with it I will send you another big FREE book describing my Radio-Electronic training.



**GET FREE BOOKS**

**SPRAYBERRY ACADEMY OF RADIO**

F. L. Sprayberry, Pres.  
Room 2055  
Pueblo, Colorado

Please rush my FREE copies of "HOW TO MAKE MONEY IN RADIO, ELECTRONICS and TELEVISION," and "HOW TO READ RADIO DIAGRAMS and SYMBOLS."

Name . . . . . Age . . . . .

Address . . . . .

City . . . . . State . . . . .

Tear off this coupon, mail in envelope or paste on Penny postcard.

**MAIL COUPON NOW !**



Incorporating  
SHORT WAVE CRAFT TELEVISION NEWS  
RADIO & TELEVISION

MEMBER  
AUDIT BUREAU OF CIRCULATIONS

HUGO GERNSBACK, *Editor-in-Chief*  
FRED SHUNAMAN, *Associate Editor*  
I. QUEEN, *Editorial Associate*  
ELMER FULLER, *Shortwave Editor*  
A. PASCALE, *Production Manager*  
G. ALIQUO, *Circulation Manager*  
JOHN J. LAMSON, *Advertising Director*  
ALFRED STERN, *Promotion Manager*

### IN THE NEXT ISSUE

Receiver for 32-Volt Plants  
Television and the Amateurs  
A Home-built Code Recorder  
Ultra-High-Frequency Tuning  
Cathode-Coupled Amplifiers

Published by Radercraft Publications, Inc.  
Publication Office: 29 Worthington Street,  
Springfield 3, Mass.

Editorial and Advertising Offices: 25 West  
Broadway, Tel. RE2-9690, New York 7, N. Y.  
Chicago Advertising Office: Radio-Craft, 520  
North Michigan Avenue, Tel. Superior 7306,  
Chicago 11, Ill.

Cleveland Advertising Office: 405 Erie Bldg.,  
Cleveland, Ohio. Burdette Phillips, Manager.  
Tel. Main 9645.

Los Angeles Advertising Office: 606 South  
Hill Street, Los Angeles 14, Calif. Ralph W.  
Harker, Manager.

New England Advertising Office: 411 Lafay-  
ette Street, Salem, Mass. Claude C. Smith,  
Manager.

San Francisco Advertising Office: 582 Market  
St., San Francisco 4, Calif. Ralph W. Harker,  
Manager. Tel. Garfield 2481.

RADIO-CRAFT is published monthly on the  
25th of the month preceding that of date;  
subscription price is \$2.50 per year in U. S.  
(In foreign countries, 75c additional per year  
to cover postage; Canada, 50c additional.)  
Special rates for members of the Armed Forces  
in U. S., or those addressed by A.P.O. or F.P.O.  
mail, \$2.00. Entered at the post office at  
Springfield as second-class matter under the  
Act of March 3, 1879. All communications  
about subscriptions should be addressed to:  
Circulation Manager, Radio-Craft, 29 Worthing-  
ton St., Springfield 3, Mass.

Notice of CHANGE of ADDRESS should  
reach us at least one month in advance. When  
ordering a change, please furnish an address  
stencil impression from a recent wrapper if  
you can. Address changes cannot be made  
without the old address as well as the new.

#### Foreign Agents

London—Atlas Publishing and Distributing  
Co., Ltd., 18 Bride Lane, Fleet St., London,  
E.C. 4.

Melbourne—McGill's Agency, 179 Elizabeth  
St., Australia.

Text and illustrations of this magazine are  
copyright and must not be reproduced without  
permission of the copyright owner.  
Copyright, 1945, Radercraft Publications, Inc.

## Contents

May, 1945

Volume XVI, No. 8

Editorial: Radar Possibilities.....	by Hugo Gernsback	477
Radio-Electronics Monthly Review.....		478
Postwar Citizens' Radio.....	by S. R. Winters	481

### ELECTRONICS

Klystron Circuits.....	by Capt. Eugene E. Skinner	480
Radar Principles, Part II.....	by R. L. Smith-Rose	484
Future Aspects of Television, Part II.....	by Dr. Lee DeForest	485
Police Radio on V.H.F.....		487
Electrostatic Modulator.....	by R. S. Havenhill	505
H. F. Heating at a Glance.....	by William Lyon	510

### WAR-TIME RADIO

Electrons Train Aviators.....	by T. R. Kennedy, Jr.	486
Army Radio Communications.....		490

### RADIO TRAINING

Amateurs and Postwar Radio.....	by Raymond Lewis	483
Speech Amplifiers, Part VIII.....	by Robert F. Scott	491
Broadcast Equipment, Part VIII.....	by Don C. Hoefler	495

### TEST INSTRUMENTS

Test Comparator.....	by Wm. F. Frankart	496
Practical V.T.V.M.....	by Wm. B. Miller	497
Better Signal Generator.....	by L. Lane	522

### SERVICING

Voltage Regulators.....	by Jack King	489
Rapid Conversion.....	by W. G. Eslick	492

### CONSTRUCTION

Capacitor and Resistor Codes.....	by Stuart Distelhorst	493
How to Repair Electric Clocks.....	by Homer L. Davidson	518
Low-Voltage Receiver.....	by Paul Abramson	528

### SOUND

Sound Units and Sound Ratings.....	by T. H. Phelan	488
------------------------------------	-----------------	-----

### DEPARTMENTS

World-Wide Station List.....	by Elmer R. Fuller	500
New Radio Electronic Devices.....		506
Radio-Electronic Circuits.....		508
Try This One!.....		512
Progress in Invention.....	by I. Queen	516
Communications.....		532

### ON THE COVER

The cover illustration this month is from Warner Brothers' picture "Objective Burma." It represents the Hollywood idea of Radar installations and probably does not resemble any "real or fictitious" equipment used anywhere on earth. The cone-shaped hoods are apparently shades for cathode-ray tubes and the long racks, directed antennas.



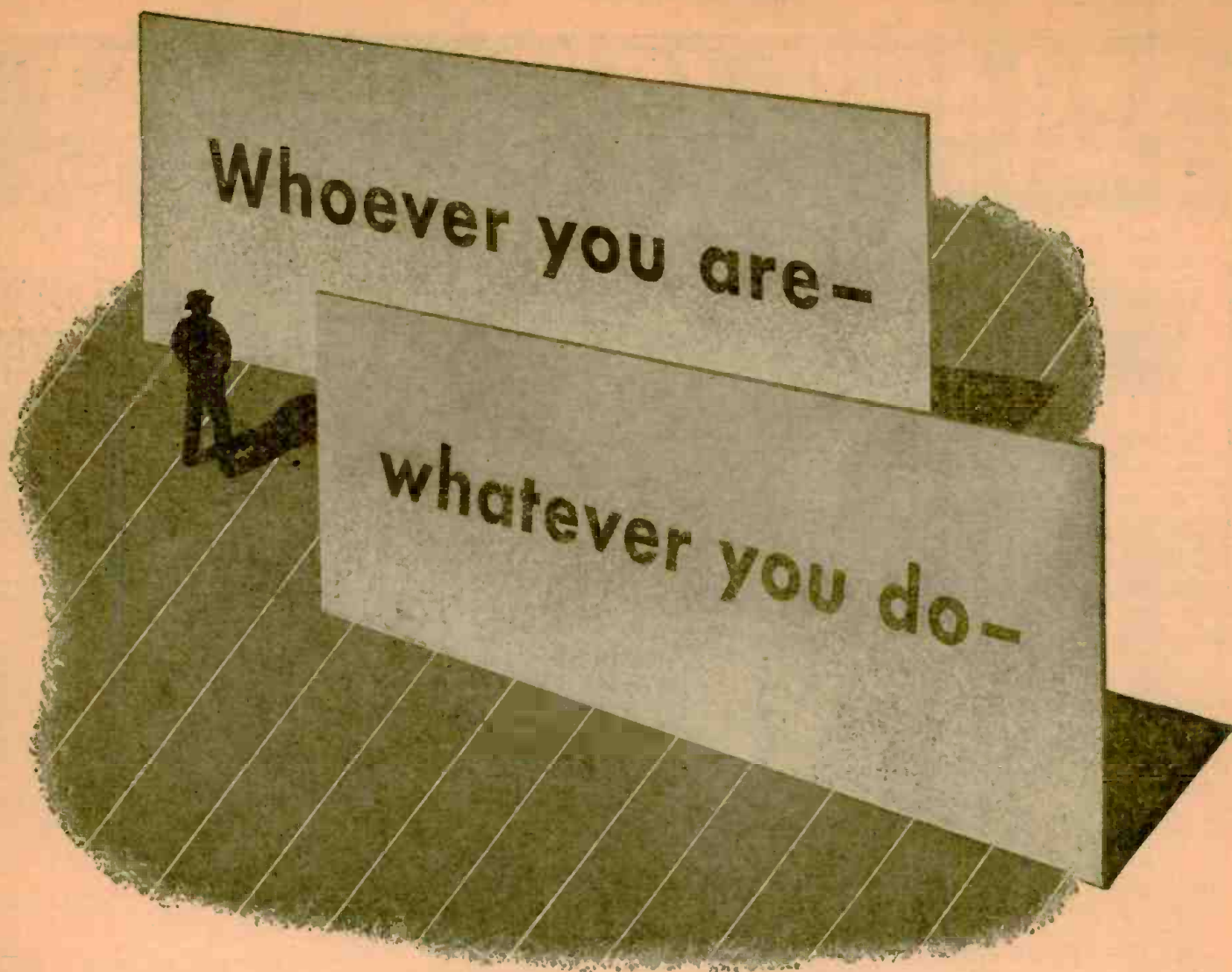

## YOU NEED hallicrafters EQUIPMENT in high frequency development work



• The new Hallicrafters AM/FM receiver, Model S-36, designed for maximum performance on the very high frequencies. Provides continuous frequency coverage from 27.8 to 143 Mc. Covers old and proposed new FM bands.

Rail and motor lines, maritime services and universally expanding aviation are planning new or improved communications systems to keep up with the forward pace. In these and many other fields of science there is an urgent demand for the latest developments in very high frequency and ultra high frequency apparatus. In your work in these fields, look to Hallicrafters for advanced communications and electronics equipment.



BUY A WAR  
BOND TODAY!



THE HALLCRAFTERS CO., MANUFACTURERS OF RADIO  
AND ELECTRONIC EQUIPMENT, CHICAGO 16, U. S. A.

# SPRAGUE TRADING POST

A FREE Buy-Exchange-Sell Service for Radio Men



## Three Star Performance!

Note that the Sprague Army-Navy E Flag now contains THREE stars. These stars, coupled with the original flag presentation, means FOUR separate citations for outstanding service in supplying Sprague Capacitors and Koolohm Resistors to match the exacting demands of the nation's armed forces.

Such a fact explains better than words why it has sometimes been impossible to meet all civilian needs for these products. But it also shows beyond question of doubt that you can rely on Sprague Capacitors and Koolohm Resistors for the utmost in service and dependability!

Ask for them by name. We'll appreciate it!

**WANTED**—Any kind of test eqpt. for radio or electrical work. Will pay cash, also tubes and parts. J. C. Jones, 10-C-1 Uphur Drive, Wilmington, N. C.

**WANTED**—One Hammarlund HQ-120X or Hallcraft SX-28 in good condition. List price. Alfred Stewart, Arapahoe, Neb.

**FOR SALE**—Triplet freepoint tester unit, latest model, compl. with adapters and sockets for all tubes. Want used CE Examometer made by Solar. Buford Brown, Box 307, Trion, Ga.

**URGENTLY NEEDED**—Echophone EC-1 in good condition for soldier. Sammy's Radio Service, Rushville, Ill.

**SALE OR TRADE**—Davrad tube checker Series 11 \$10; No. 305 Radio City tube tester, \$15; 5 amp. Triplets meter, \$3.75; 0-7-140 Weston voltmeter, \$5; 608-1-15 mfd. Readrite capacity meter, \$3; 25,000 ohm meter, \$1.75. Want Rider's manuals, tubes, or parts. Glenn Fessenden, Box 1006, Glendrie, Mont.

**FOR SALE**—12" Atwater Kent dynamic speaker; Knight power supply 350v, 65ma, 2.5v fil. power transformer 295CT, 6.3v 6L, 110v primary 1927 Steinlite 7 tube receiver with speaker. Also want two No. 26 tubes. Wayne Larrick, RD No. 1, Box 92, Cuyahoga Falls, Ohio.

**WILL TRADE**—for Press or reflex camera: two G-E meters 2 and 3 amps; 2 Westinghouse meters 1.5 and 10 amps; 3-2" square Triplets 100-100-200 miles; UTC transformer 848; Thordarson T-11M70; and 3-HY40Z and 1-807 tubes. Wm. H. Brown, Jr., 1003 Ross St., Alliquippa, Pa.

**FOR SALE**—Two JFM 90 General Electric frequency modulation sets, new, never used. 9 tubes, 2 limiters each. Receivers without audio. Retail value \$59.50 ea. E. L. Cox, 2035 West Academy St., Winston Salem, N. C.

**WANTED**—Cash for Hickok No. 2108 zero current voltmeter or any other good V-O-M with large meter. Don Y. Yen, Rockford, Mich.

**FOR EXCHANGE**—National SW3 receiver with tubes and coils less power supply and speaker for Rider's manuals Nos. 7 and 8. Earle B. Drake, 730 Channahon St., Taunton, Mass.

**FOR SALE OR TRADE**—Scarce tubes such as 129Q7, 5Z4, 6BK7, 6J7, etc. Write for list. S/Sgt. J. C. Davenport, 18025080, 2725 N. 15th A., Waco, Texas.

**FOR SALE**—024 tubes in sealed cartons. Wellington Radio Service, Marvin Wellington, Oswego, Kansas.

**WANTED**—Late N.R.I. or Sprayberry radio course, complete. State year and price. Frank Dirks, Hebron, Nebr.

**FOR SALE**—6V8, 6C5, 6B8, 6F5, 25A5, 5U4, 6B4, 5V4, 5Z4, 6R7, 82, 84, 6A5, 6N7, 1H4, and many other new tubes. Also one 12" Jensen P. Ms. Pk. McDevitt Radio Service, 17 Monument St., Charlestown, Mass.

**URGENTLY NEEDED**—Two 35Z5 and 50L6 tubes. Also modern tube tester. Thomas Morris, R.F.D. 3, Box 247, Charleston, W. Va.

**WANTED BY EXPERIMENTER**—Coils; condensers; mica, tubular, electrolytic and variable tubes and resistors. Andrew R. Harar, R.D. No. 2, Birdsboro, Pa.

**FOR SALE**—New tubes in cartons, 50% off list price: 1G4, 1H5, 1P5, 1H5, 1S5, 1T4, 3Q5, 384, 6F6, 6L6, 6SA7, and many others. Also new Boken high fidelity sound system, complete with speakers and mike. D. Jarden, 7149 Ardleigh St., Philadelphia 19, Pa.

**WANTED**—Two No. 47 tubes; also information on 50L6, 35L6, 117Z6, and 6A7. What have you? Norman C. Hascall, Black Point Rd., Scarsboro, Me.

**WANTED**—A-1 78 rpm phono motor, preferably variable speed. Gene Shumway, Box 485, Sterling, Kansas.

**URGENTLY NEEDED**—Rider's manuals. W. J. Mitchell, P.O. Box 483, Anoka, Fla.

**FOR SALE OR EXCHANGE**—1941 Radio Circuit Manual (by "Radio-Craft"), in original carton; Supreme No. 35 tube tester, with oetal adapters; and Lifetime ribbon mike with banquet stand. Want Superior multi-meter No. 1250 and sig. scanner No. 1230 or equivalent. L. B. Mundy, 709 Palace Blvd., Clifton Forge, Va.

**URGENTLY NEEDED**—Late model sig. generator. Preferably Philco No. 010 or Triplet; pocket size V-O-M; and 50L6, 70L6, 35L6, 6A8, 1N5, 1H8, and 1A7 tubes. Fred Kagi, 825 Magnolia Ave., Orlando, Fla.

**WILL SWAP**—R.C.P. No. 312 tube checker and cash for Hickok 510 or 155 traceometer. Peters Electric Co., Box 621, Clawson, Mich.

**WILL TRADE**—Large stamp collection including first day covers, censor covers, mint singles, name blocks of flags, etc., for communication receiver or recorder. J. Wong, 970 S. San Pedro St., Los Angeles 15, Calif.

**WANTED**— $\frac{1}{4}$  or  $\frac{1}{2}$  h.p. variable speed motor. William Loftstrom, 1302 West Hill Ave., Valdosta, Ga.

**FOR SALE**—Philco No. 088 voltmeter, F. Andrasek, 22 Portland Ave., Clifton, N. J.

**URGENTLY NEEDED**—Multimeter tester and signal generator. Will buy any test equipment you have for sale. Cash. To be used for helping the boys in the Pacific. Ord's L. Bradford S1/c, 974-00-54, USNR, Fire Station No. 3, USNRB Bay No. 10, % F.P.O., San Francisco, Calif.

**WANTED**—One or more of following tubes: 1A5, 1A7, 1H5, 1N5, 6A8, 12SA7, 12SK7, 12SQ7, 35L6, 35Z5, 50L6, 80 and 117M7-GT. Roser F. Cain, Savannah, Mo.

**FOR SALE**—Rider's manuals, No. 2 through No. 12, all new, \$150; Extra No. 4, \$7.50; Weston No. 663 analyzers, \$30; No. 665, \$50; three No. 301 meters, \$7.50 ea.; Supreme 339 deluxe analyzer, \$15; Supreme No. 333, \$35; Supreme No. 520 universal AC bridge, tests res., capacity, and inductance, \$50; Clough-Bronle O-C oscillator 55ke to 30mc, \$35; VTVM Sylvania designed, \$35; Jewell analyzer AC 4 ranges to 160v DC to 600v Ma to 150, \$20. Joe Konecny, 3420 Holland Ave., Saginaw, Mich.

**WANTED**—RCA-Rider chanalyt 162-C. Cash for used one, or one that needs repairs. Wm. E. Seiby, 761-7th St., S.E., Washington 3, D.C.

**WANTED**—1, 2, or 3 of following tubes: 1A7, 7A8, 25L6GT, 25Z5, 35Z5GT, 50L6GT, 117Z6GT. C. B. Davis, 681 Delmar Ave., Atlanta, Ga.

**FOR SALE OR TRADE**—Electronic converter 32v DC to 110v AC, 100 watts. Want portable record player or G.I. recording unit. Phillip H. Birches, Box 243, Ellsworth, Kans.

**URGENTLY NEEDED**—Good used Philco or other good make signal generator. Describe fully. W. M. Finley, Jr., Norfolk, Ark.

**FOR SALE OR TRADE**—Meter dials, multiple range volt, ohm, milliamperes. Any size for large or small meters. Want large 0-1 mil or less meter, bellows camera, enlarger and other photo eqpt. J. L. Oxyen, Pewaukee, Wis.

**FOR SALE**—Mallory vibrators: Type 4-4, 6v; P290, 32v; 271, 6v; and one very heavy duty 6v unit; also one 6v vibrator power transformer for D.D. output tubes. All perfect. \$8.50 for lot. P. A. Rosenblatt, P.O. Box 905, Hoboken, N. J.

**FOR SALE**—One Superior channel analyzer, new, has never been used, \$30. Henry Schnapp, Box 62, Nuela, Colo.

**FOR SALE**—Philco 016 push button signal generator, \$15. Norman Berg, P.O. Box 185, Hillsboro, Kans.

**WILL TRADE**—EC-3 in good condition for either SX-25 or SX-28, paying any cash difference. Howard O. Whipple, 14-23-121 St., College Pt., L. I., N. Y.

**WANTED**—Superior No. 1240 tube tester, also Knight 7- or 14-watt amplifier system. Cash. H. G. Radcliffe, 1013 High St., Petersburg, Va.

**TUBES TO TRADE**—One each: 117Z6GT; 1H5GT; 1N5GT/G; 1T5GT; 50L6GT; 35Z5GT; 12SK7GT; 12SQ7GT; 12SA7GT; 56; 71; 78; 26, all new or practically new. Want late sig. generator or will trade tubes and pay difference for SX-23 Super Skyrider. Allen Admro, Jr., 1545 W. 253 St., Box 1268, Harbor City, Calif.

**WANTED**—Small VOM such as Triplet 666, Supreme, Precision or Philco, Cash. G. Samkowsky, 527 Bedford Ave., Brooklyn, N. Y.

**WANTED**—Late emission type tube tester with instructions, also 4- or 5-tube small table radio; 1A7G or GT tube. J. M. Sawyer, 2604 Holmes Ave., Springfield, Ill.

**WANTED**—Hallcraft SX-24 or SX-25 receiver. Sgt. Anthony Brocato, Jr., 393 F.A. Bn., Hq. Btry., Camp Hood, Texas.

**FOR SALE OR TRADE**—Sprague DeLuxe Tel-Ohmike No. TO-2, used only a few times, in original carton. Tubes Preferred as part payment such as 1A7, 1N5, 1H5, 35L6, 50L6, 35Z5, 117Z6 and 12v type. M. G. Dozier, 1208 College Ave., Titton, Ga.

**WANTED**—Hallcraft 9-19R or SX-24 or National, Howard or Echophone No. 1 to 6 receiver, \$25 to \$75 maximum. Also port. amplifying record player, maximum, \$20. A. Carlson, Post Box 601, Lewistown, Mont.

**FOR SALE**—Scott Phantom chassis in perfect condition, 19 tube, 16 watts output, \$200. Santor Radio Service, 165 W. 98 St., New York, N. Y.

**WANTED**—Superior channel analyzer and sig. generator, late model tube checker and v.t. voltmeter. Rufus P. Voorhies, P.O. Box 128, New Iberia, La.

**WANTED**—50L6; 35Z5; 12SJ7; Metal 614 or what have you new or in good used condition? Weavers Auto Electric, Red Lodge, Mont.

**FOR SALE**—Weston voltmeter No. 301 8v d-c; Weston Thermo-galvanometer No. 425. Want Philco or G-E record player, also 35Z5; 35L6 and 12K7 tubes. Frederic H. Perau, 16 Tracy Ave., Batavia, N. Y.

**FOR SALE**—Std. brands 7C7 tubes, perfect substitutes for 12SK7's, 65c ea. post-paid, minimum quantity two. W.E. 211E @ \$1.50 ea.; 104-D @ 35c ea. Ph. Rosbert, P.O. Box 905, Hoboken, N. J.

### SEND US YOUR OWN AD TODAY!

For over two years now, the Sprague Trading Post has been helping radio men get the materials they need or dispose of radio materials they do not need. Literally thousands of transactions have been made through this service. Hundreds of servicemen have expressed their sincere appreciation of the help thus rendered.

Send your own ad to us today. Write PLAINLY—hold it to 40 words—or less—confine it to radio materials. If acceptable, we'll gladly run it FREE OF CHARGE in the first available issue of one of the five radio magazines wherein the Trading Post appears every month.

HARRY KALKER, Sales Manager

Dept. RC-55, SPRAGUE PRODUCTS CO., North Adams, Mass.  
Jobbing distributing organization for products of the Sprague Electric Co.



# SPRAGUE CONDENSERS KOOLOHM RESISTORS

TM. REGISTERED U. S. PATENT OFFICE

Obviously, Sprague cannot assume any responsibility, or guarantee goods, services, etc., which might be exchanged through the above advertisements



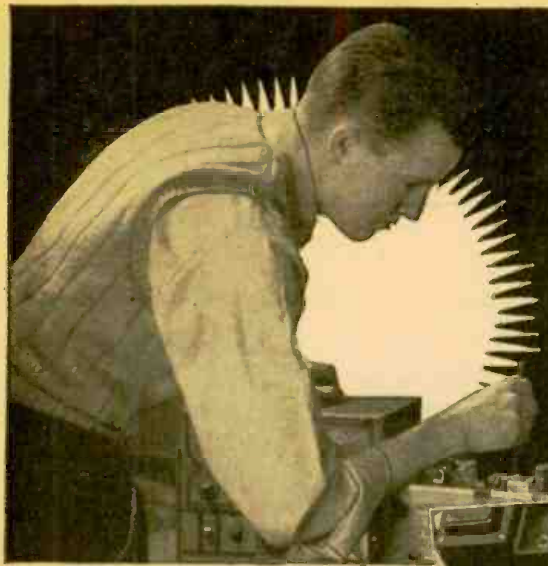

For Good Jobs TODAY...  
TOMORROW...LEARN

# RADIO ELECTRONICS DeFOREST'S A-B-C WAY!

**T**HE fast-moving Opportunity Field of Radio-Electronics needs many trained men! Let DeFOREST'S show you how to get ready to take advantage of the breaks—the good jobs—the satisfying pay checks of today—and the bright postwar opportunities of tomorrow. Write for DeFOREST'S big, free book—"VICTORY FOR YOU" and colorful kit supplement.

### Consider Radio's Many Fields

See how you may cash in on a vast field that includes F.M. Radio, Communication Radio, Electronics, Broadcast Radio, Motion Picture Sound, Radio Sales and Service—or a Radio business of your own.

### Start a Business of Your Own

See how DeFOREST'S has helped many get their start in Radio-Electronics—helped them to good pay jobs in one of our most promising industries—others to preferred military classifications with higher ratings, better pay. Helped others to full or part time sales and service businesses of their own.

### Employment Service!

DeFOREST'S also provides an effective EMPLOYMENT SERVICE which has long-established contacts with many employers who use DeFOREST'S trained Radio-Electronic men.

### Mail the coupon Now—Today!

See how DeFOREST'S can help YOU get started toward this fascinating work by means of its effective "A-B-C" Training Method—in your spare time.

**VETERANS: Check coupon below for special information.**



**A "LEARN-BY-DOING" FROM PRACTICAL EQUIPMENT**  
Make 133 interesting Radio-Electronic experiments at home—from 8 BIG KITS of Radio parts and assemblies. Quickly build Radio Receiving Circuits that operate... a Light Beam Transmitter... Wireless Microphone... Radio Telephone... "Electric Eye" Devices. Scores of other fascinating projects.

### B GET INTERESTING, LOOSE-LEAF LESSONS—

90 modern, well-illustrated loose-leaf lessons, prepared under the supervision of one of the world's foremost Radio authorities, Dr. Lee DeForest, often called "The father of Radio!"

The Billion Dollar Radio-Electronic Industry, with its Manufacturing, Servicing, Broadcasting, Communications, and many other promising fields, invites your careful consideration. See how DeFOREST'S helps you prepare for a good pay job, or a business of your own in one of America's most promising, interesting fields.

DeForest's Home Training offers instruction in Motion Picture Sound Equipment, FM Radio and Television. Residential Training in modern Chicago laboratories is also available. Write for details.



See Radio Circuits in Action—Electrons on the March—with this genuine DeVRY Projector

### C USE "LEARN-BY-SEEING" MOVIES

with a genuine DeVRY 16mm. Movie Projector and Films to help you learn Radio faster... easier. See hidden Radio action come to life! Radio waves in motion—*Electrons on the march...*

E. B. DeVry, President  
DeFOREST'S TRAINING, INC.  
2535-41 N. Ashland Ave., Dept. RC-B<sub>2</sub>  
Chicago 14, Illinois, U.S.A.

Please send me your "VICTORY FOR YOU" book and KIT FOLDER, FREE.

Name..... Age.....  
Address.....  
City..... State.....

If under 16, check here for special information.

If a veteran of World War II, check here.

### READ WHAT THESE MEN SAY ABOUT DeFOREST'S TRAINING

"I have obtained employment with the... Mfg. Company. They speak highly of DeForest's students and state they have had excellent results with your men whom they have employed."  
*Clifford Taylor, Mass.*

"As a result of DeForest's Training, I am doing very well. If my income doesn't range between \$50.00 and \$75.00 per week, I figure something is wrong."  
*Lyle Rielly, Wisconsin*

"But the credit must go to you and your employment service for placing me in this job when I really needed one. I shall always be grateful for the help and guidance given me by you and DeForest's Training. Thanks a million."  
*Earl Eichelberger, Illinois.*

"I cannot impress too strongly on anyone who may be considering taking your course the value of both the training and the employment service that goes with it. This service is not merely an empty promise, but a truly conscientious effort that continues until its job of preparing you is done."  
*Philip Cummins, New Jersey.*

"I am amazed at the many subjects I have learned with DeForest's. I also want to praise your motion picture lessons. It is truly amazing, how well the action of electricity is brought out. I feel safe in saying that no book could ever establish effectively those principles and actions so well in my mind."  
*Yale Schorr, Texas.*

**DeFOREST'S TRAINING, INC.**  
CHICAGO 14, ILLINOIS

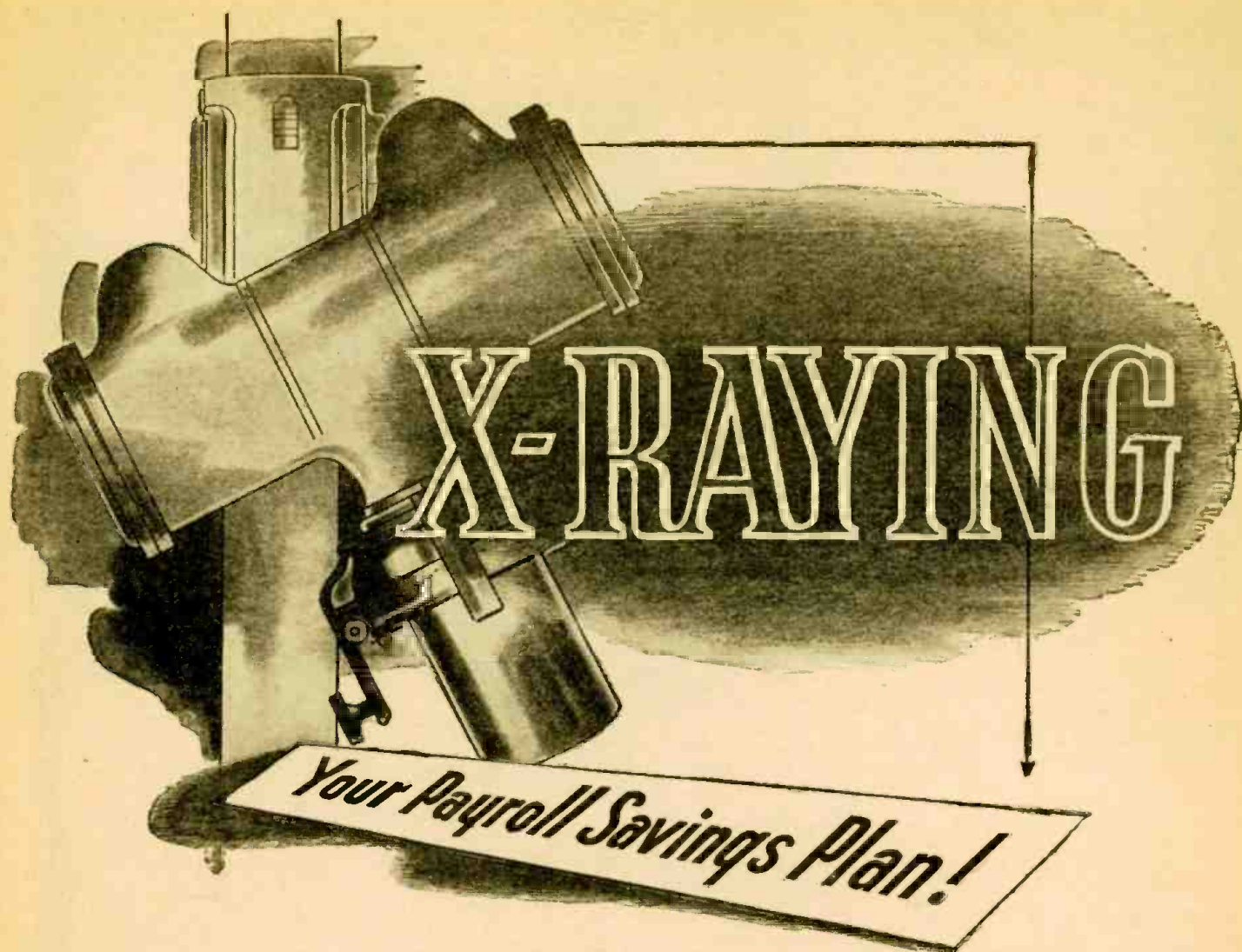

We can all see with the naked eye that the Payroll Savings Plan provides the most stable method of war financing. Analyze it under the X-ray of sound economics and other important advantages are evident.

A continuous check on inflation, the Payroll Savings Plan helps American Industry to build the economic stability upon which future profits depend. Billions of dollars, invested in War Bonds through this greatest of all savings plans, represent a "high level" market for postwar products. Meanwhile, putting over Payroll Savings Plans together establishes a friendlier re-

lationship between management and labor.

To working America the Payroll Savings Plan offers many new and desirable opportunities. Through this systematic "investment in victory," homes, education for their children and nest eggs for their old age are today within the reach of millions.

The benefits of the Payroll Savings Plan to both management and labor are national benefits. Instilling the thrift principle in the mind of the working men and women, the Payroll Savings Plan assures their future security—and is a definite contribution to the prosperity of postwar America!

*The Treasury Department acknowledges with appreciation the publication of this message by*

## RADIO-CRAFT

*This is an official U.S. Treasury advertisement prepared under the auspices of Treasury Department and War Advertising Council.*

**MAKE MORE MONEY**

**IN**

**Radio TELEVISION & ELECTRONICS**

**Now!**

**GET THESE 2 BIG BOOKS**

**FREE!**

You men already in Radio know how great the demand is for trained, experienced servicemen, operators and technicians. You know how fast the field is growing and how important it is to keep up with developments — F.M. Receivers, Electronics and Television. You know, too, a fellow cannot learn too much about any industry for **REAL SUCCESS**. Whether you have experience or are merely **INTERESTED** in radio as an amateur, you must recognize the **WONDERFUL OPPORTUNITY** right within your grasp to cash in on your natural abilities. Make them pay dividends. Get into the **EXPERT RADIO SERVICE FIELD**. Be an F.M. and **TELEVISION specialist—OWN A BUSINESS OF YOUR OWN**, if you prefer. Fill out and mail the coupon below for all the details of our plan.

Here's Just a Few of the Interesting Facts you Learn with the **FREE MANUAL**.

1. Routine for diagnosing Radio Troubles.
2. Preliminary Inspection of Receivers.
3. How to Check Power Supply.
4. How to Identify Various Stages of Receiver.
5. How to Trace the Circuit and Prepare Skeleton Diagram.
6. How to Test and Measure Voltages.
7. How to Test Speaker in Audio Stages.
8. How to Test Detector, I.F., R.F., and Mixer Stages.
9. Complete Reference Table for Quickly Locating Receiver Troubles.

Get the Latest Inside Information—Short Cuts—Trade Secrets by



**SHOP METHOD HOME TRAINING**

**FROM A REAL ESTABLISHED RESIDENT SCHOOL**

Now the famous National Schools brings its exclusive Shop-Method of training right into your own home. You can learn the most up-to-date, approved projects, systems and circuits step by step in your spare time. This is the sound practical training you want and need—the development of experienced instructors working with thousands of students right in shops, **NEW F.M. broadcast studios** and **experimental laboratories of NATIONAL SCHOOLS**—one of the most advanced trade educational centers in the world.

**National Trained Men Now Making the Best Money in History**

The real value of National training shows up on the quick progress our men make on the job.

Incomes that seemed fantastic only a short time ago are now being reported by National graduates. And this is only a sample of what the future holds for the **MAN WHO KNOWS RADIO, ELECTRONICS, F.M., TELEVISION** and allied subjects. National is proud of the progress its graduates are making all over the world. Read the facts—the actual proof in the books we send you **FREE**.

**LEARN BY DOING**

Work with Real Experimental Equipment Furnished without Extra Cost as Part of Your National Training

*Experience is the best teacher.* You learn by experience with the exclusive National Shop-Method of Home Training. In the course of your study you actually build various types of receivers—a powerful superheterodyne, a signal generator, an audio oscillator and others—You make tests and conduct experiments that *show you the why and how of things*. You understand what makes the various elements of electronics operate because you actually see them work for you. Not only do you gain marvelous experience by this method of learning but you receive valuable equipment you will use on the job in the practice of your profession as an electronics expert. *Mail the coupon* and learn what this means to you.

Send the Coupon and prove to yourself what **YOU can do in RADIO!**

**Be Sure Of Your Success And Security After The War**

Don't let your post-war ambitions lag. Don't let **YOUR** future depend on others. **Build a career for yourself.** Never in all history has the returning serviceman, or war worker been confronted with such a great future if he reaches out and grasps it **NOW**. Here is a new world opening before you. Get ready now while you are still in uniform—while you are on your war job. Then you can soon step into an essential, well paid position or, with little capital, **GET INTO BUSINESS FOR YOURSELF**. It isn't a bit too soon to start now. Radio men are vitally needed. **Fill out and mail the coupon immediately** and examine the **NATIONAL SHOP METHOD HOME TRAINING COURSE** carefully, without obligation.

**FREE LESSON INCLUDED**

Examine the exclusive National Shop Method of Home Training. See for yourself how sound and practical it is. Be convinced that you can learn Radio, Electronics, Television—quickly and easily in your spare time. You can't tell until you try. This trial is **ABSOLUTELY FREE**. Fill out the coupon immediately while you are thinking about it and drop it in the mail at once.

Mail the coupon here for the books that tell you the complete story of the marvelous new system of training in Radio, Electronics and Television. Learn the facts of this exclusive shop-method of home training. See for yourself! **DECIDE FOR YOURSELF!**

This is the **MODERN SYSTEM OF TRAINING**; it matches the rapid progress constantly being made in Radio, Television and Electronics. It is **TIME TESTED**, too. National Schools has been training men for more than a third of a century. It is the very same training that has helped thousands to more pay and greater opportunity. You owe it to yourself—your future—to read the book "Your Future in Radio, Electronics and Television"—**FREE** to you when you send in the coupon.

**NATIONAL SCHOOLS**

LOS ANGELES 37, CALIFORNIA EST. 1905



**MAIL OPPORTUNITY COUPON FOR QUICK ACTION**

National Schools, Dept. 5-RC

4000 South Figueroa Street, Los Angeles 37, California.

(Mail in envelope or paste on penny post card)

Mail me **FREE** the books mentioned in your ad including a sample lesson of your course, without obligation. I understand no salesman will call on me.

NAME ..... AGE .....

ADDRESS .....

CITY ..... STATE .....

Include your zone number

# SYLVANIA NEWS

## RADIO SERVICE EDITION

MAY

Published in the Interests of Better Sight and Sound

1945

**SYLVANIA  
SERVICEMAN  
SERVICE**

by  
**FRANK FAX**



Newest of Sylvania Electric's technical bulletins on Tube Substitutions is the 20 page "Aids To War-Time Servicing" that servicemen throughout the country are finding most helpful in these days of radio tube shortages.

The manual is another Sylvania contribution to assist servicemen in meeting the present acute shortage of many tube types. In addition, it contains several charts of diagrams showing adaptor circuits commonly required.

This bulletin is available free on request from your Sylvania distributor, or from Sylvania Electric Products Inc., Emporium, Pa.

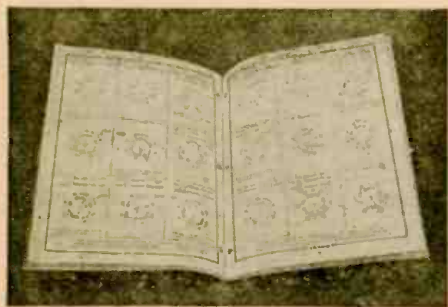

## Sylvania Expands Service Aid with New Radio Tube Substitution Manual

*Full Data Contained in New 20-page Bulletin Superseding Earlier Guides*



Recognizing, early in the war, the difficulties that would result from tube shortages, Sylvania Electric immediately took steps to aid servicemen in tube substitution problems. Early in 1942, Sylvania published—and distributed free to servicemen—a 4-page bulletin, "Correlation of Tube Types for Substitution."

### MORE EXTENSIVE DATA

This bulletin proved so helpful to servicemen that Sylvania continued this service in the Technical Section of Sylvania News, and then decided to re-issue the information in more comprehensive form. An enlarged, more fully developed "Radio Tube Substitution Charts for War-Time Servicing" appeared in 1943. This was a

6-page bulletin containing information based in part upon the WPB civilian radio tube program, permitting complete presentation in one convenient folder.

Now, newest and largest of these Serviceman Service charts is a 20-page manual entitled "Aids to War-Time Servicing" presenting the latest in Sylvania Tube Substitution Charts and containing 4 full-page charts of 9 diagrams each describing adaptor circuits.

### CONSISTENT POLICY

Publication of this book is the latest step in Sylvania Electric's consistent policy of assisting radio servicemen to carry on their business efficiently and profitably.

# SYLVANIA ELECTRIC

SYLVANIA ELECTRIC PRODUCTS INC., Emporium, Pa.

MAKERS OF RADIO TUBES; CATHODE RAY TUBES; ELECTRONIC DEVICES; FLUORESCENT LAMPS, FIXTURES, ACCESSORIES; INCANDESCENT LAMPS

# RADAR POSSIBILITIES

. . . Radar is bound to play a prominent radio role in the postwar period.  
There will be literally thousands of new peace-time applications . . . .

HUGO GERNSBACK

**R**ADAR is not a new or wartime radio invention—indeed it is older than radio itself, its instrumentalities antedating even early wireless.

Actually it was Henrich Hertz, the illustrious discoverer of electro-magnetic waves, who was the first one to experiment with microwaves during the 80's. He refracted them through a pitch prism, just as we refract light rays through a glass prism. It is the same microwaves to which we have returned during the present World War, using them in modern radar.

Radar—which is nothing but a radio echo whereby microwaves are sent out in one direction and which bounce back from a solid medium or a water surface—has many uses besides the present war applications, whereby planes, ships, warships, etc., can be detected at night and through fog; whereby airplane navigators can detect their objectives at night or during fog and bomb the object which they cannot see.

For peace-time use the radar idea will find applications which are not even dreamt of today. First and most important, saving human life through prevention of collisions is probably the most urgent need. Radar on locomotives will prevent not only head-on collisions, but rear-end collisions with other trains as well. Fog, thick weather and darkness, whether at night or in tunnels, do not interfere with radar. What is true of trains is equally true for airplanes, which no longer will collide with other planes in flight nor run into mountains at great loss of life, as at present. Ships at sea will not collide either with other ships, nor will they run into icebergs or other obstacles, including uncharted, newly-made volcanic islands. Automobiles can be made practically collision-proof because radar will stop head-on and rear-end auto collisions. A driver who has gone to sleep will not crash into another car, if his own car has been made collision-proof by means of radar instrumentalities. It is possible even with the driver asleep to brake his car automatically by a radar system in order to prevent crashes. These are only a few and the most obvious uses of radar and any technician can let his imagination run wild if he wishes to think up new applications on the radar principle. Anything that moves anywhere may be radar equipped for safety or other

purposes if found necessary, practical, or convenient.

This also suggests many industrial uses in factories, plants, mines, etc., where radar not only will save untold lives and accidents but also will speed up work.

One of the important uses of radar in the future will be in a rather unsuspected quarter. As aviation progresses, long distance travel is tending to move into the higher strata of the earth's atmosphere. Now it so happens, in the upper regions of the atmosphere (where we are approaching a vacuum) space abounds in meteors and meteorites which move at the terrific speeds of between four and seven miles a second. This is a far greater speed than that at which the fastest bullets and projectiles move today. Should a small meteorite strike a plane or rocket-machine, it would go through it with the same facility as a bullet cuts through butter. So far, engineers have not had to bother themselves much about meteorites for the reason that the earth's atmosphere protects our planes. Meteorites striking the upper regions of the atmosphere immediately melt and volatilize. The composition of these foreign bodies—of which actually several million strike the earth's atmosphere every hour is mostly iron mixed with some nickel and other metals. They may vary from the size of a pea to the size of a house and larger.

Radar in the future will be able to anticipate strikes of such meteorites and the navigator will be able to change his course so that the larger size ones will not strike the plane or flying machine. The danger to the machine only becomes acute once we start to fly through the upper regions of the earth and its extreme attenuated atmosphere.

Another new use of radar has just been announced by the *Civil Aeronautic Administration* to make postwar air travel safer than it is today. Radar is expected to increase the safety factors of flying in fog, snow, rain, or when the ground is obscured by clouds. This is called "instrument weather" by pilots.

The C.A.A. experimental station at Indianapolis is working on the perfection of two radar devices, one for airport use and the other a collision warning device used in the airplane itself. Almost ten carloads of radar equipment has been lent (Continued on page 507)

## Radio Thirty-Five Years Ago

In Gernsback Publications

**F**ROM the May, 1910, issue of *MODERN ELECTRICS*—"Special Wireless Issue":  
Bellini-Tosi Station at Boulogne, by *A. C. Marlowe*.  
Directive Aerials, by *George F. Worts*.  
Radio Telephone Experiments.  
Auxiliary Loose-Coupled Tuner, by *Walter E. Kever*.  
Wireless for Dispatching Trains.  
A 100-Mile Wireless Station Using the Duplex Aerial, by *Richard H. Foster*.  
Transmitting Pictures.  
New Electrolytic Detector.  
New Oscillograph.

HUGO GERNSBACK Founder	
Modern Electrics	1908
Electrical Experimenter	1913
Radio News	1919
Science & Invention	1920
Radio-Craft	1929
Short-Wave Craft	1930
Wireless Association of America	1908

Experimental Wireless Telephone, by *Moore Stuart*.  
A Further Help to Tuning.  
Directive Aerials, by *Bernadotte Anderson*.

Wireless Lightning Protector, by *Warren N. Crane*.  
Tubular Variable Condenser.  
Duplex Detector, by *J. C. Berckman*.  
Universal Detector, by *Thomas Durry*.  
Laboratory Transmitter, by *Harold S. Nash*.  
A New Receiving Circuit, by *Milton Goodman*.  
A Duplex Aerial, by *Russel Rankin*.  
A Simple Sending Condenser, by *William F. Crosby*.  
Wireless with a Static Machine, by *Moore Stuart*.

**A** LLOCATIONS for all the chief public and government radio services are to be complete by May first, according to reports from sources close to the FCC.

It is expected that by this time even the opposing proposals for FM assignments, which have been put forth with much vigor and some occasional heat, will have been reconciled, probably with the help of information on propagation conditions which may not be permitted to become public during the war.

The FCC expects to go into the matter of clear channels for broadcast stations as soon as the more general allocations are disposed of—probably early in the second week of May.

**R**UBBER curing methods which speed the process 17 times by the use of electronics were revealed last month by officials of the Firestone Tire and Rubber Co.

Vulcanization—the joining of sulphur and rubber molecules—is accomplished through the application of heat. When steam is used, the heat must soak in slowly from the outside. The thicker the product, the longer time required for the heat to reach the core.

Electronic equipment, on the other hand, heats the entire product almost instantaneously throughout and brings it up to the required temperature in seconds or minutes depending on size and thickness. The product to be heated is placed between two metal plates that are supplied high-frequency alternating current by an electronic generator, and is raised in temperature by internal molecular friction.

The company's foamed sponge rubber—Foamex—was cured in 30 minutes by steam and in four minutes by electronics. After it is cured Foamex is dried with hot air. It takes 16 hours to dry foamed sponge rubber with hot air alone, but if it is treated electronically for 30 seconds the drying time is reduced to an hour.

Large hard rubber wheels can be cured in 18 minutes with electronics, but if the job is done with steam it takes five hours. Actually the electronic treatment is applied only two minutes, then the rubber wheel is placed in a steam mold for 18 minutes, to finish the cure and give it shape. Brake blocks are cured in seven hours by steam and in 48 minutes by electronic heat.

A 20 per cent saving is achieved in the curing time for garden implement tires and the figure is much greater with larger tires. Elastic thread can be cured electronically in 1½ minutes, while 15 minutes are needed if steam is used.



Checking adjustments on the high-frequency rubber vulcanizer. A small tire, seen under the disc-shaped plate at right, is undergoing treatment. Note the shielding screen around work and directly above the apparatus.

# Radio-Electronics

## Items Interesting

**A** RADIO TUBE Task Committee has been created to advise on methods for increasing production of radio receiving tubes, the War Production Board announced last month. Requirements for 1945 are about 25 per cent higher than the 12,000,000 a month required in 1944, according to WPB.

The members of the new WPB task committee are Peter G. Noll of the International Union of United Automobile Workers of America (A.F.L.) and Elmer Chamberlain, Charles A. Rackliffe, Alfred Stern, and Frances Saylor of the United Electrical, Radio and Machine Workers of America (C.I.O.).

At the first meeting of the committee, Harold Sharpe, assistant director of the radio and radar division of WPB, and Major William A. Gray, chief of the tube section of the radio and radar division, outlined future production requirements. The WPB officials reported that the Army and Navy are doing all they can to place orders promptly as an aid to facilitating increased production this year. The committee expressed the view that existing manufacturing facilities, if fully utilized, are sufficient to increase production to the extent required, in spite of the fact that the lower schedules for 1944 were not quite met.

There is no immediate prospect, however, it was pointed out, that the civilian tube supply situation will improve materially. Rather, it is expected to remain about the same as in late 1944, approximately one and a half million tubes a month.

Regarding the availability of tubes and electronic equipment following the end of the European War, it was said that although certain military requirements may fall off, much of the electronic equipment used in Europe would either have to be tropicalized—made moisture and fungus proof—or replaced by new equipment for use in the Pacific theater. In either event, it would appear a continued burden will remain upon the manufacturers of military equipment.

**S**HORTAGES in radio equipment other than tubes may be alleviated somewhat through surpluses not required by military orders, it was understood from a WPB release last month.

Distributors were advised that lists of available excess or surplus electronic materials may be obtained at all WPB regional offices immediately upon publication each month. Materials in inventory after the expiration of a 45 day period become available for civilian supply, it was stated. Any distributor may request release of excess material, and if not taken on rated orders in the 45 day period, release is usually approved.

Due to the specialized needs of the tropical Pacific theatre, military requirements will not fall off greatly it was stated.

As transformers were reported as becoming critical again, due largely to increasing military demands, closer control by WPB is anticipated, although available production capacity is believed greater than military needs.

Aluminum phonograph records are "out" except for high rated orders, it was reported, remaining supplies being available only to broadcasting stations making master records, and then only when filling such orders as would not interfere with military and OWI requirements.

**V**ACANCY on the Federal Communications Commission has been filled with the appointment of Charles R. Denny to the last unfilled post. The nomination was greeted with general satisfaction, as Denny is well known to Congress as Commission spokesman at hearings of both the House of Representatives and the Senate in the last two years.

Mr. Denny, a native of Baltimore, was born in 1912, and is the youngest man ever appointed to the FCC. He is a graduate of Amherst and the Harvard Law School, and was chief of the Appellate section of the Department of Justice Lands Division until 1942. Joining the FCC then as assistant general counsel, he succeeded general counsel Telford Taylor when the latter went into the service late the same year.

**F**ORECAST of a postwar radio market of 60,000,000 home radios—enough to keep radio production at peak for six years is made in the stockholders' quarterly report of Westinghouse Electrical and Manufacturing Co., issued last month.

Five factors are enumerated that will affect the postwar market. They are: 1. Frequency Modulation (FM) radio will hasten total replacements by outmoding practically all sets now in use; 2. The demand for radio-phonographs will increase the size of the market by increasing the average sale; 3. Returning service men, establishing new homes, will represent a huge new market; 4. The surface has only been scratched in the market for extra sets to provide listening convenience throughout the home; 5. A steady growth in home television is anticipated.

# Monthly Review

## to the Technician

**CONVERTERS** to permit reception of FM signals on the new frequencies can be constructed for \$8.85, it was proved by experiments made last month by the engineering department of the FCC.

Patterned along the design of remote-control tuning devices and wireless record players which can be used with a standard broadcast receiver, the FCC converter can be operated from any convenient location in a room with the present receiver. If operated from an arm-chair, you can tune stations in and out without touching your main receiver, making it a lazyman's remote control.

The converter was developed by the FCC as a result of protests from FM broadcasters at recent hearings following the publication of proposed frequency allocations.

These broadcasters declared that by moving FM up in the spectrum, thousands of expensive receivers now in the hands of listeners would become obsolete. The FCC has replied by offering this converter, that is capable of converting an FM receiver geared to the present 42-50 megacycle band where FM is now located, so that it can receive the 84-102 megacycle band to which the FCC plans to move FM.

Any radio amateur or handyman can build one of these FM converters, which is about the size of a cigar box, at a total cost of \$8.85 for parts that are now available in radio stores. Commercial ready-built converters will also be available for about \$11. No special knowledge is needed to install one of these converters. The converter in no way affects the fidelity of tone and the quality of reproduction of sound in the FM receiver.

One of the converters demonstrated at Washington was a one-tube, the other a three-tube device with power pack.

It is believed that FM broadcasters may take steps to make these converters available to their listening audience at cost in the event that FM is shifted in the spectrum.

**BROADCASTERS** were called upon to take voluntary action against an alarming trend toward excessive commercialism, in a speech last month by Paul A. Porter, new head of the Federal Communications Commission.

The FCC chairman warned that the Commission is considering new license renewal procedures which would require station owners to show that operation of their stations is actually in the public interest, as required by communications law.

"In cases," stated Mr. Porter, "where commercial opportunities have caused a complete abandonment of other services which the broadcaster has agreed to perform. . . . Are we of the commission to assume that the statutory standard of public interest becomes a mere negative presumption and that so long as the licensee violates none of the specific prohibitions against obscenity, lotteries and the like, the regulatory authority is not to inquire further?"

**TELEVISION** for the postwar world was demonstrated last month by the Radio Corporation of America in a series of showings to press representatives staged in cooperation with the National Broadcasting Co.

Featuring an image five times larger than those of pre-war sets, the new receivers use the Schmidt optical system with plastic lenses (*Radio-Craft*, December, 1944) and project a 16 x 21-inch picture on a special plastic screen. Two different optical problems had to be overcome by special features of the new translucent viewing screen. One problem faced by the designers was a tendency which the screen would normally have to develop a "hot spot," resulting in a glare in the center and insufficient light in other parts of the image. The other problem was the need for distributing a major portion of the transmitted light to the area which the spectators would occupy in relation to the receiver.

A new development is the automatic fre-

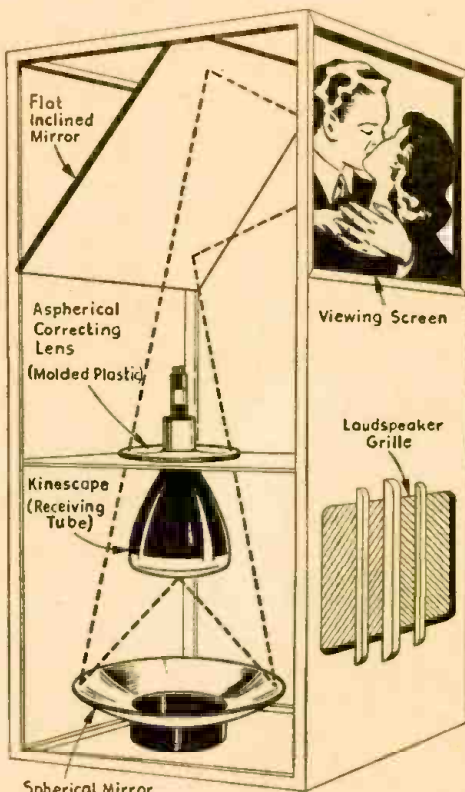

Simplified view of the large-screen receiver.

quency control, which discriminates between the transmitted synchronizing impulse and any stray noise impulse, which otherwise might trigger the sawtooth wave voltage prematurely, by fixing a time interval for the former and shutting out impulses which do not arrive on schedule.

Without some such control, noise interference could throw the scanning beam in the receiver out of synchronization with the one in the transmitter, causing the former to "black out" and return on some lines of the picture before they were com-



Size of RCA's new screen may be seen above.

pleted. "Tear outs" and ragged edge effects would result. Preventing this form of distortion, the new system regulates reception in somewhat the same way that a fly-wheel regulates machinery.

Brightness of the picture is largely due to the new high-voltage cathode ray tube, which is far more effective while substantially smaller and lighter than the pre-war direct-viewing tube.

Designed to operate at 27,000 volts—nearly four times the voltage used in pre-war picture tubes—the new tubes produce a much brighter initial image. This high initial brilliance, in conjunction with the efficiency of the optical system, makes it possible to obtain from a tube with a face diameter of only five inches a bright, clear image on the screen that is more than five times as large as could be produced on a pre-war direct-viewing tube with a face diameter of 12 inches.

**D**UPLICATING in three days a German vacuum tube, American scientists made available to Yank fighting forces strategic telephone equipment abandoned by the Nazi armies in their retreat in Belgium and France, said the *Bell Laboratories Record* last month.

In retreat the Germans had left their communications equipment substantially intact, except that they removed nearly all the radio tubes.

The Army turned a sample tube and the problem over to an official of the Office of Scientific Research and Development. It wanted 1,000 duplicates at once. Rushed to the United States, the tube was examined by engineers of Bell Laboratories and the Western Electric Company.

The German tube was a cathode-type pentode made by Siemens Halske. It was different from any known American tube not only in electrical characteristics and in heater voltage but also in the dimensions of the bulb and base and in the arrangement of the pins which fit into the socket base. Furthermore, as is common in Europe, the bulb of the tube was sprayed with metal for purposes of electrostatic shielding.

Within three days eight replicas of the German tube were designed from available parts used in American tubes, some of which had to be adapted, and the tubes were on their way to the battlefield in Europe. Within three weeks the entire 1,000 tubes were delivered.

# Klystron Circuits

"Tube of the Future" as Oscillator and Amplifier

By CAPTAIN EUGENE E. SKINNER\*

In the October, 1944, issue of *Radio-Craft*, the author published an article on the Klystron, "Tube of the Future," in which the operation of the tube was explained. A reference to that or any similar article will refresh the reader's memory of these basic fundamentals.

In using the Klystron, it should be remembered that the positive side of the

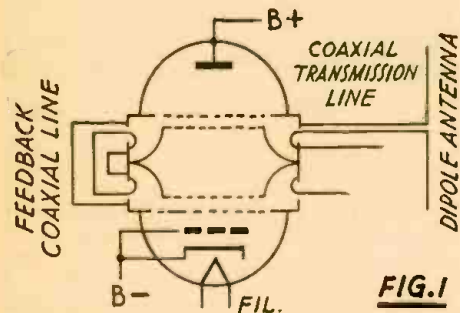

FIG. 1

## BASIC KLYSTRON OSCILLATOR CIRCUIT

voltage supply is grounded, and that the high negative voltage is connected to the cathode. All the transformers and the power supply must be insulated for this high voltage, which is usually in the vicinity of 3,000 volts, and the usual safety precautions should be taken as for any high voltage equipment. For this voltage, a typical Klystron may deliver an output of about 10 watts. One of Sperry's Klystrons is rated at 20 watts.

Although tuning may be accomplished in a number of ways, the Klystron lends itself particularly to a simple mechanical method. A vernier tuning knob, as shown in the photograph, gives a frequency change of 1.35 megacycles for each turn of the knob. This vernier tuning mechanism operates on a micrometer principle, and operates a wedge which mechanically varies the distance between the buncher and catcher grids by changing the overall length of one of the three tuning struts used with each cavity, which operate against a center ring midway between the two resonators, strengthening the anode end and the cathode end away from the center, changing the distance between the buncher and catcher grids. The end plates are normally kept firmly against these struts by tension springs. A second widely used method of adjusting the frequency is that of changing the volume of the resonant cavities by inserting adjustable metal plugs in the side. A combination of this and the previously described method will give a very satisfactory range of frequencies for most purposes.

Input and output connections, and connections between the two cavities are made through "antenna seals," which are the terminals for coaxial cables, and are connected to single loops inside the cavities, giving inductive coupling with the flux inside.

Like the ordinary vacuum tubes, the Klystron lends itself to a number of differ-

ent applications. Its widest use is as an oscillator, but it is also widely used as an amplifier, and can be applied as a detector, modulator, mixer, or frequency multiplier.

The basic Klystron oscillator circuit consists of the Klystron itself, a power supply, and an antenna (if radiation is desired), together with the necessary connecting cables. There is no connection to the input antenna seal of the tube, and the output is connected through a coaxial cable to the antenna, which is normally a dipole type. The B+ is grounded to the metal shell of the tube, and the B- is connected to the cathode. This is the oscillator in its simplest form, and as such is a transmitter within itself. In this basic form, the power is not very great, but when the pertinent facts are considered, it is realized that not a great deal of power is needed. For example, for the range of frequencies for which Klystrons are needed, it is a simple matter to make a very highly directional antenna, so that practically all of the power radiated is beamed right where it is desired to send it. In the second place, due to the very small bending effects in the ultra-high-frequencies, the range of the transmitter is, for all practical purposes, limited to the line-of-sight distance. Figure 1 shows this basic oscillator circuit, with the connections to the power supply and antenna.

The power supply must be well regulated, as the tube will not maintain a stable frequency if the voltage is not stable. Also, there are limitations in the voltages which may be used, as the tube will oscillate for a given adjustment only at certain voltages. This limitation is due to the transit time characteristics of the tube. Except for these two points, the tubes act much the same as ordinary triodes. This tube acts as an amplifier, and any amplifier will oscillate if it has sufficient gain and enough output energy is returned to the input to overcome the losses. An equivalent triode oscillator circuit is shown in Fig. 2.

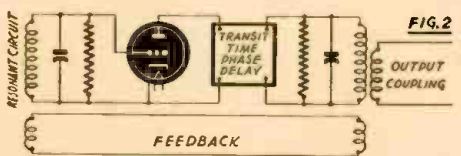
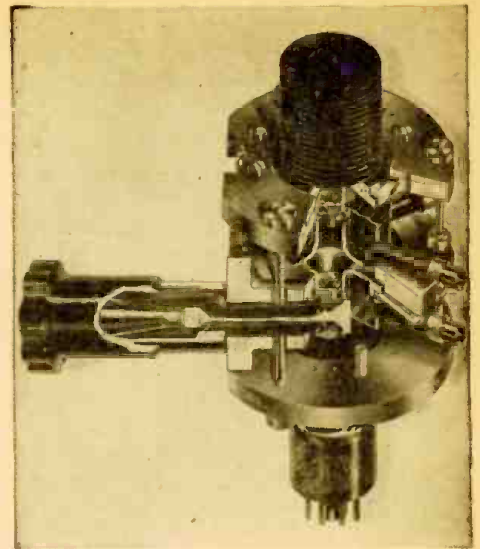

FIG. 2

## TRIODE CIRCUIT EQUIVALENT TO KLYSTRON OSCILLATOR

As can be readily seen, the resonant portion of the equivalent circuit is composed of a coil-and-condenser combination which is the equivalent of the walls and pair of grids of the buncher cavity. The added block in the equivalent circuit represents a circuit which would be necessary to introduce the transit time phase delay, but which would not affect the circuit as an oscillator. The output of the equivalent circuit is another coil which is the equivalent of the coaxial cable coupling of the buncher cavity. The feedback is accomplished by an inductive connection in both cases—by a few twisted wires in the equivalent circuit, and by a coaxial cable in the Klystron—but by inductive coupling, nevertheless, even though the difference in



Courtesy Sperry Gyroscope Co.

Cut-away shows Klystron's internal construction, co-ax leads and vernier tuning screw.

frequencies requires different physical methods.

The Klystron will stop oscillating if it is overloaded. In connecting the feedback to the Klystron for an oscillator, a short coaxial cable is used. The total phase shift must be  $2\pi N$  radians, where  $N$  is any number except zero. There are several factors which cause phase shifts, but this coaxial cable can be cut to the proper length to allow sufficiently for them and attain the necessary  $2\pi N$  radians.

When the Klystron is used as an amplifier, the signal voltage is applied to the buncher by means of the buncher antenna seal. The output is taken from the catcher cavity by means of another antenna seal. The function as an amplifier is accomplished when, in addition to the external source of power of the proper frequency fed to the buncher, the situation is such



FIG. 3

## TRIODE CIRCUIT EQUIVALENT TO KLYSTRON AMPLIFIER

that more energy is delivered to the catcher from the electron stream than is needed to drive the buncher. Efficiencies of about 15% as power amplifiers, and voltage amplification of about 20 are possible. It is obvious that the operation of the tube as an amplifier is radically different from the conventional vacuum tube amplifiers. The equivalent amplifier circuit is shown in Fig. 3.

In this circuit, the input is coupled into the grid through the inductive coupling from some external source. No coupling is used between the input and output circuits, all of the output being fed to some other point by another inductive coupling. The output of the tube and the output coupling are separated as in the oscillator equivalent circuit by a transit time phase delay.

Some Klystrons are provided with a grid between the catcher and collector which makes possible the use of the tube as a detector. This grid is slightly positive so that when no excitation is applied to the buncher, most of the electrons emerging from the catcher reach the collector. When the buncher is excited, the field builds up in the catcher, and slows down some of the electrons so that the collector current is reduced. By adjusting the bias of this

(Continued on page 513)

\*Headquarters, Army Air Forces Training Aids Division.



# Postwar Citizens' Radio

## Microwave Transmitter-Receivers Will Invade Our Private Lives

By S. R. WINTERS

**W**HEN the dogs of war have been quelled, swords may not be converted to plowshares but the "walkie-talkie" and "handie-talkie," as symbols of compact combination radio transmitters and receivers, will switch to peace-time uses with the ease of flipping a coin. These vest-pocket editions of radio will have applications too numerous to be computed, too flexible to be defined.

On the basis of recent hearings (extending over a period of weeks) before the Federal Communications Commission there is a 200-page report, amassed by 231 radio technicians—a forecast of things to come in radio and electronics. Dryly labelled "Docket No. 6651," it may become as famous for its implications upon the radio structure of the future as was infamous the "little black bag" in the Government's Teapot Dome oil scandal. This bulging, brown radio volume is a blueprint of tomorrow's radio. Not only has the Federal Communications Commission turned prophet, with an unbridled imagination, but within a single volume it has pieced together, in jigsaw puzzle fashion, a compendium of radio's varied services, such as: citizen radiocommunication service, theatre television, centercasting, general mobile radio service, facsimile broadcast service, motion picture radio stations, geophysical service, or radio prospecting, radio for electric, gas, water and steam utilities, police radio service, limited private radio-telephone service, taxicab radio service, and bus, railroad and highway radio services.

### RADIO FOR THE CITIZENS

Of these allocations of frequencies to various categories of non-governmental services, in the spectrum from 10 to 30,000,000 kilocycles, there is none so new and none so challenging to the imagination as the projected "Citizens Radiocommunication Service." Without the usual demands for frequency assignments in an already overcrowded spectrum, the Federal Communications Commission did the startling thing of voluntarily allocating the band from 460 to 470 megacycles to a multitude of private uses of radio, just over the postwar horizon. It was a generous gesture of recognition of "walkie-talkie's" war contribution. This government move was as if to say to all light-weight, portable, short-range types of radio, "You have performed admirably on the battlefronts—now the doors swing wide for peace-time opportunity of performance." Instead of the proverbial sky or Heavside layer being the limit, the Commission asserts that the possible uses of low-power, portable transmitters are as broad as the imagination of the public itself, and its adaptation is circumscribed only by the ingenuity of radio manufacturers in devising equipment to meet the varied applications.

The vision of a Jules Verne or a Hugo Gernsback alone could match the Federal Communications Commission in lifting the veil of the future—forecasting the startling civilian uses of the war's walkie-talkie, the airplane pilot's throat microphone and the vest radio with wrist microphone, earphones under cap, and transmitter in special pockets. Not visionary, but just over the hori-

zon of actual accomplishment, the war-converted walkie-talkie will contact a physician from a central exchange while he is en route by automobile to a patient's home; the farmer's wife who formerly summoned her husband to the noon-day meal with a clanging dinner bell will call him on 460 megacycles; hunters exploring the far reaches of forests or swamps, in search of wild game and fish, will be in contact by radio with a central hunting and fishing lodge; department stores, dairies, laundries and similar business concerns will communicate directly by radio with their delivery trucks en route; city firemen will employ the throat microphone, now used by aviation pilots in detecting speech by the quivering of the throat; and cowboys on our western plains will carry vest-pocket editions of radios to communicate with home or ranch.

The Federal Communications Commission has assigned separate bands of frequencies for urban and rural transit radio contacts. These voice channels may be used for communicating with city or inter-city buses, trucks, taxicabs, etc. Such radio services may assume the pattern of a common carrier or on a private basis using the limited frequencies allotted for such

purposes. Anyway, this citizens' radiocommunication band will be available to taxicabs, delivery vehicles, such as laundry and bread trucks, and similar mobile units, in addition to service as incidental communication between fixed points.

Common carrier operation in the citizens' radiocommunication channel of frequencies will not be permitted by the Commission; no fee can be charged for the sending of messages and no charge made for the use of licensed facilities. Thus the service will be for the private use of the person licensed and he will be governed by the regulations of the Communications Commission. The 460-470 band allocated to the public is said to be admirably adapted to short range communication, requiring only feeble power. However, the government rules are sufficiently flexible to allow the use of "booster" or automatic relays. The low-power transmitters will not utilize extremely high antennas, but increased transmitting power will be permissible in remote rural areas, where interference is absent.

Flexible, too, is the design of the combination transmitter and receiver, although its weight will be kept to a minimum and preferably mounted in a suitcase. A broadcast receiving unit, an alarm outfit, or a remote control system may be incorporated with the transmitter in the suitcase, variable

(Continued on Next Page)

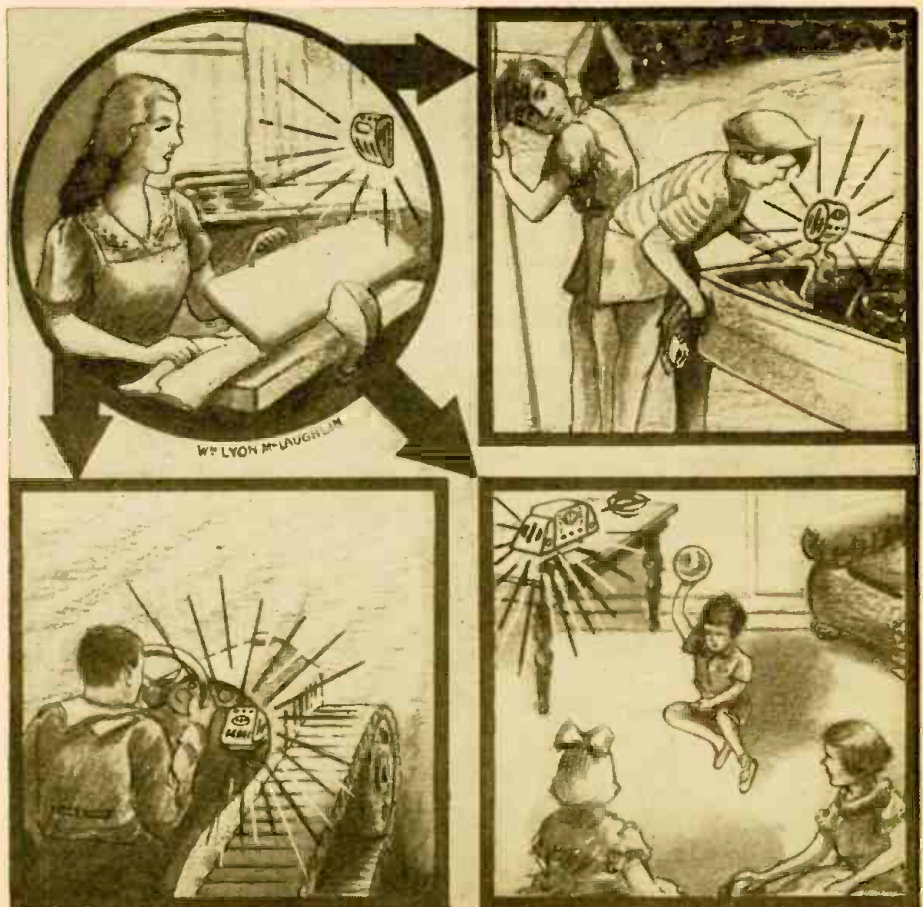

The postwar mother has her master unit right beside her in the kitchen, thus keeping watch over children in the nursery and communicating with others at camp or husband in the fields.

(Continued from previous page)

as the particular needs may dictate. Following the policy of the service to radio amateurs, the Commission will not assign individual channels within the allotted band. The use of simple circuits, already known to the radio art, will mean that both transmitters and receivers will be tunable over most of the 460-470-megacycle range—emitting sufficiently sharp signals to prevent any possible interference.

This new public radio service is designed to serve the greatest possible number of users, hampered by only a few requirements of the Communications Act, and a minimum of traffic rules need be imposed. No technical knowledge is required to participate in the "Citizens Radiocommunications Service," and the operator's license takes the simple form of a small card, remaining in force for a five-year period. The particular licensees are not cloaked with immunity from interference; they have no vestment in any frequency or channel—instead, it is a mutual opportunity to share this new band with others. Radio technicians assume that the 10,000 kilocycle width of the band is ample for its purpose.

### "VOTES BY RADIO" TURNED DOWN

As a parallel to the Crosley and other popular polls by sampling the opinions of select individuals, the so-called "Center-casting" (See "Votes by Radio," *Radio-Craft*, March, 1945) as "a means of radio voting or polling" was refused the requested assignment for radio frequencies. Nonetheless novel as an offshoot of radio developments in the immediate post-war period, the system and instruments involve the use of a graphic recording device, named the "audimeter." It is at present installed in home radio receiving sets, supposedly representing a cross-section of homes, determined by a sampling procedure based on data obtainable from the Bureau of Census of the U. S. Department of Commerce. The listening record appears on a continuously moving wax-coated tape, indicating with precision the day, hour, and minute that a particular radio receiver was switched on, each and all stations intercepted, the number of minutes of listening to each station, the amount of dial twisting, and just when the receiver was turned off. Possessing such data, the company sponsoring "Center-casting" is able to determine the number of minutes listened to each program. Currently, this service has been sold to 40 clients, including the broadcasting networks, commercial advertisers, and advertising agents.

Realizing that radio affords the only speedy avenue of communication for the operation and control of fire-fighting equip-

ment in going to or from a conflagration, the Federal Communications Commission has tentatively assigned 15 radio channels for governing the movement of trucks and other mobile units, as well as firemen, while the latter are working in burning buildings or areas. A home fire is burning somewhere in this country every one and one-half minutes and, startlingly enough, a fire fans out to 50 times from its incipient stage within eight minutes. Thus, it is significant that 92 cities with populations exceeding 100,000, and 890 cities with populations ranging between 10,000 and 100,000 persons, have indicated to the Federal Communications Commission their intentions to adopt radio as an agency to combat fires. In addition to the fixed radio stations required in each of these municipalities, it is estimated that 128,000 mobile fire department units will be equipped with radio equipment soon after the cessation of hostilities.

The FCC has issued permits for the operation of eight fixed radio stations, and 175 portable and portable-mobile stations by transportation companies. These stations are in operation in Chicago, Cleveland, Detroit, Fort Wayne, Philadelphia, St. Louis, Seattle, Washington, Columbus, Spokane, Pittsburgh, Boston and New York City. Stations in Chicago, Cleveland, Detroit, New York, Philadelphia, St. Louis and Boston are employed exclusively in connection with transit operations in the respective cities; in the other cities mentioned above, the radio stations are used jointly with local power companies. Twenty other transit companies have indicated their intentions of building radio stations as soon as the equipment is available.

### FOR HIGHWAY MAINTENANCE

Highway maintenance departments are also utilizing the facilities in speeding up the prosecution of work incidental to road upkeep. Excepting the California Division of Highways (which operates a chain of special emergency radio stations comprising 23 fixed stations and 36 mobile units), all of the highway maintenance agencies use radio jointly with state police forces. The Michigan State Highway Department, operating a ferry service across the Straits of Mackinac, is authorized to operate five ship radio stations and two limited government coastal harbor stations.

A "Motion Picture Station" is operated as an intermittent service. It functions for communication purposes in conjunction with the filming of moving pictures. Studios employ radiotelephone signals between headquarters in Hollywood and film colonies on remote locations, aboard ships, or in isolated, rugged areas. Infrequently, radio may be used by motion picture con-



By their very numbers, Citizen Radios will make reliable communication possible in time of emergency or disaster.



cerns as an agency to conserve life and property, when the invisible waves are the only medium of communication between studios and locations far removed from what we of the city call civilization.

With the stringency of gasoline rationing unrelaxed, the proposal to use radio in dispatching Cleveland's 430 taxicabs augurs a trend rather than accents an example. These cabs are now being dispatched by wire lines, but by way of the ether the driver, immediately preceding the discharge of a passenger, would report to headquarters his cab number and the location at which he was or would be available. His car would then remain at the designated location until otherwise instructed by radio. In this manner, taxicab "cruising" would be sharply curtailed and the ordinary mileage of Cleveland's 430 taxicabs reduced from 4,000,000 to 3,000,000 miles.

Electronics, just a continuing process in the unfolding of the broad aspects of radio, also will afford limitless vistas in the post-war world. Tiny electronic devices will avert automobile and airplane collisions; traffic signals within motor cars and planes will glow as red and green warning signals. Even the dashboard instruments will function electronically; electric eyes will automatically turn on auto headlights as darkness blankets the arteries of commerce; tourists traveling from New York City to California will transfer the responsibility of guiding the steering wheel over to a photoelectric cell which will scan a white line on the highway—and follow it unerringly. Such are the vistas of radio and electronics—just beyond the horizon—when the fierce dogs of war bark no longer.

Less than one out of every twenty U. S. radio-listener families—or less than 2% of the American public—can be reached regularly by Axis propaganda, even if all short-wave receivers were capable of receiving enemy programs. This fact was learned from a recent survey of radio listeners conducted by Sylvania.

The survey revealed that about 52 out of every 100 sets now in use may be tuned to short-waves although 37% of them are never used for short-wave reception. Even among the short-wave listeners more than half said they listen rarely or occasionally and only ten percent said they listened frequently. Evidently Americans have little or no interest in what the axis broadcasters have to say and so much if not all of the enemy radio propaganda falls on deaf ears.

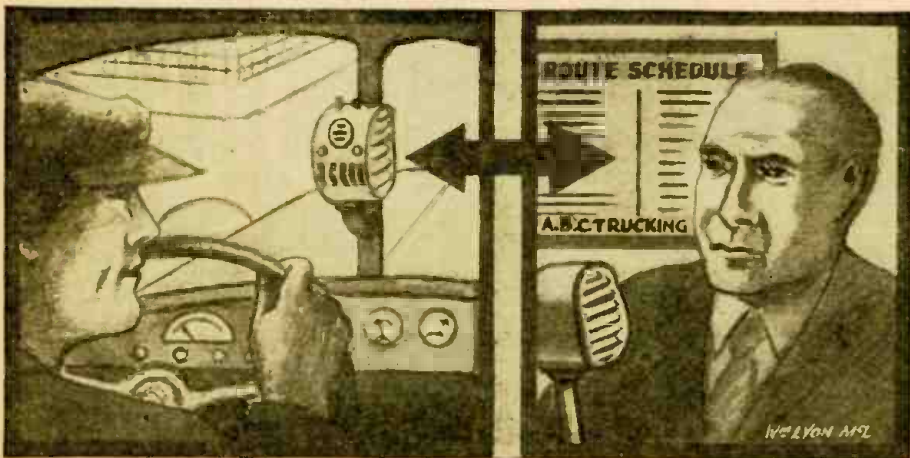

It is doubtful whether this is within the scope of Citizens' Radio or will need a commercial license. In any case, radio will be widely used for office-mobile unit communications.

# Amateurs and Postwar Radio

By RAYMOND LEWIS

WHEREVER amateurs gather, there is talk about post-war plans. The war is far from won, but this can't dampen the ardor of the dyed-in-the-wool hams. In all these bull sessions though, there is a new fellow to be considered . . . the man who since the war, first learned about amateur radio. These willing converts picked up some knowledge from the jargon of the boys who knew the game "when." All the rest they know about amateur radio is what they have read in publications which say very little about ham radio as we knew it. Once brought up to date, these men and women can become a part of a hobby which is a wonderful world of science and make-believe. The more people who have post-war ideas, the better off we all will be.

## LICENSES ARE REQUIRED

To be a real amateur you need a license. Licensing requirements were then, as they still are, Class B to operate CW on all bands and phone on all bands except 75 meters and 20 meters. The Class A license is obtainable after holding the Class B for a year and grants the privilege of working phone on these two additional bands. The Class C license permits the same operation as the Class B. The only difference is that the Class C is a special affair created for those individuals who live too far away from an FCC examining center to take the tests in person. It is still possible to obtain an amateur operators license, although station licenses will not be issued until after the war. The Army and Navy take cognizance of the knowledge required to get the amateur ticket, making it a highly desirable war-time project.



Amateur Radio CT2BP, located at Horta in the Azores Islands. Transmitter at left—American receiver built into wall at right.



The station licenses may be different when the FCC starts to hand them out again. The old system was to give the three-letter alphabetical combination that was next on the list in your district. (The United States was divided into nine districts.) In some of them they had just about exhausted all possible combinations, which lends credence to the rumor that some change may be made in future licensing. If you happen to live in Florida, a 4th district state, you might end up with a call such as W4RLW. It was once considered stylish to request special combinations, but that went out many years ago when the licenses started to run into the tens of thousands. A simple little thing like a call has a lot of angles . . . does it have a good swing on a bug; is it adaptable to some catchy slogan for phone . . . but don't even give it a second thought because it's your baby from then on.

## NEWCOMER HAS AN ADVANTAGE

The war-born amateur has an advantage over the old-timer. He is starting from scratch. There are no boxes of junk which must be used. All inhibitions are off and the sky is the limit! The biggest pitfall to beware of is the mad urge to get going in the greatest hurry. That invites haywire, which somehow or other never gets cleaned up. There is no reason why this should happen to the newcomer who has already obtained a background in radio. Starting a ham station should be done in a logical sequence of steps. The first move, which is highly recommended, is to survey the antenna situation. You may be undecided as to what frequency you will start out on. If you have a rough idea whether it is going to be the VHF's or the medium frequencies, plans can be made accordingly. A good skywire is just as important for receiving as transmitting, so the effort of doing a first-class job will not be wasted. Apartment house tenants should not be discouraged since some of the finest ham work has been done from such locations. Wherever practical, use a directional array. There is nothing like a beam to put your signal where you want it, while causing your fellow hams considerably less interference.

All amateurs are in the predicament of not knowing exactly what frequencies will be available after the war. It is possible that 160 meters will not be returned to the hams. The possible creation of new bands, as

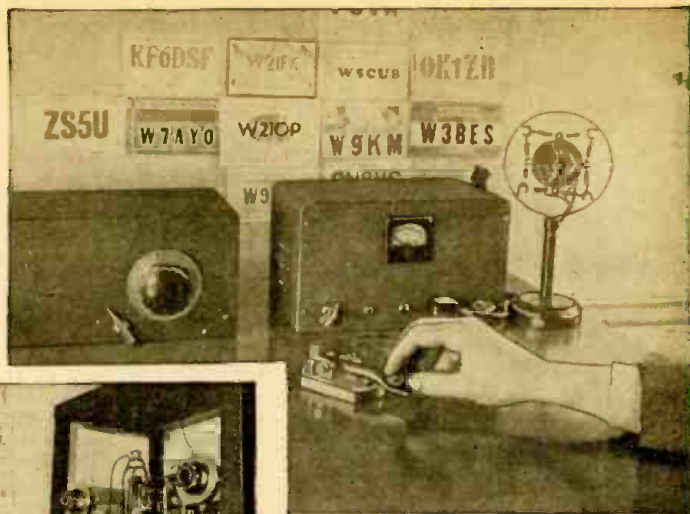

Above—Simple low-power phone and CW station. At left—Final stage of a medium-power station. Note QSL cards from all parts of the world.

outlined in the recent FCC allocations, is encouraging, but by no means final. After the United States decides what it will do, it must go into an international conference. Amateur ranks are going to increase by many thousands. The failure to recognize this with adequate frequency allocations is unfortunate in light of the war-time contributions of the amateur. We hear the old line about how the amateur will make out—developing new methods of overcoming QRM, etc. But, if they gave us another few hundred kilocycles, we could put that many more men to work on the solution. There will be plenty of QRM for everyone! In the interim, some of the commercial stations could start to share frequencies and alternate in wearing out each other's V wheels.

## SPACE FOR THE STATION

Regardless of the frequencies, you will need a place to set up a station. Those fortunate enough to have an entire room can spread out at will. If you are limited in space it will require more imagination, but a complete station can be set up in half a closet. One important thing to keep in mind is *safety-first!* Working around radio involves voltages which are dangerous. You may be competent in handling them at all times; let's hope so. Every precaution must be taken to protect others who might come in contact with the equipment. Interlocks, overload relays, screen, guards, fuses . . . in fact every conceivable safety device should be incorporated in the well designed ham shack. Better be safe than sorry!

The receiver you make or purchase should be your most careful investment. Transmitters come and go, but it generally remains a fixture over a period of years. A survey taken before the war showed that the majority of amateurs had purchased a commercially manufactured receiver. Few hams were equipped to do the precision job of building one at as reasonable a price. In either case, bear in mind that a good receiver is more important than a lot of money spent on a high-power transmitter. It is an old adage in ham radio that you can't work what you can't hear. All the features are desirable, including a crystal filter, noise limiter, AVC, etc., but they may be limited by your pocketbook or experience in building. For ultra-high frequency operation most commercial receivers were very expensive. Home built sets covering the high-frequency ranges above 5 meters were more common than manufactured receivers.

(Continued on page 529)

# RADAR PRINCIPLES

## Part II—Historical Development of Radiolocation

By R. L. SMITH-ROSE, D.Sc., Ph.D., M.I.E.E., F.I.R.E.\*

THE first applications of radio waves for determining the distance of a reflecting surface were devoted to demonstrating the existence of the Heaviside layer as a portion of the upper atmosphere, now known as the ionosphere, which is responsible for the transmission of waves around the earth. After many years of speculation with a variety of indirect experimental evidence, the first direct demonstration of the existence of the ionosphere as a reflecting region was provided by Dr. (now Sir Edward) Appleton and M. A. F. Barnett at the end of 1924 and during 1925.

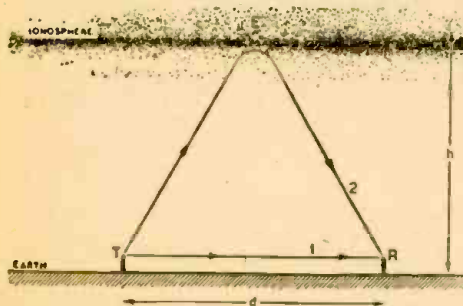

Fig. 7—How height of ionosphere is checked.

With the co-operation of the British Broadcasting Corporation the wave length of the Bournemouth broadcasting station was varied over the range 385 to 395 metres over a period of from 10 to 30 seconds, and the strength of the resulting signals at Oxford, about 100 miles distant, was measured. It was found that as the wave length was varied, the received signal passed through a series of interference maxima and minima, indicating that the signal was the result of two sets of waves arriving by different paths; one set of waves was transmitted along the ground, while the other arrived by an indirect path after reflection from a layer. After verifying that the paths were in the same vertical plane, a measurement of the number of interference fringes caused by a known change in wave length gave a measure of the height of the reflecting layer in

\*National Physical Laboratory.

the region, which later became known as the ionosphere.

This was the first classical example of the use of frequency-modulated radio waves for determining the existence and location of a reflecting layer which had hitherto remained undetected by any direct experiment. We may therefore say that the Heaviside layer was the first object to be detected by radiolocation experiments.

Shortly after the first of the above measurements were made, G. Breit and M. A. Tuve began some tests in the United States of America, using interrupted continuous waves which were the equivalent of pulses of continuous waves about 1 millisecond in duration and with a recurrence frequency of 500 per second. At the receiving station a high-speed oscillograph was used to record the incoming signals and permit the examination of their wave-form. In July, 1925, experiments were made over a distance of 7 miles using wave lengths of 71 and 42 metres, and it was observed that the received pulses nominally of square wave-form, were distorted by the attachment of humps, sometimes in duplicate. These humps clearly indicated the arrival of a second wave-train, or echo, by an indirect path; and from a measurement of its time retardation in relation to the original hump due to the direct or ground wave, the path difference of the two sets of waves could be determined. (See Fig. 7.)

In one of their publications, Breit and Tuve remark that their experiments on the above lines arose out of some work being carried out at the time on another method proposed by W. E. G. Swann and J. G. Frayne. It is also of interest to remark here that a United States patent was issued to H. Löwy on an application filed in July, 1923, for a radio-frequency counterpart of Fizeau's method of determining the distance of a reflector, to which reference has already been made. In this patent Löwy describes an electronic switch used for alternately keying a transmitter and receiver, so that the latter is only in a sensitive condition after the pulse or train of waves has been emitted by the transmitter. It is not known whether this device was put to any practical use.

In the years following the dates mentioned above, a considerable amount of research work was devoted to the development and use of methods of determining the height of the reflecting layers of the ionosphere, using both the frequency-change and pulse-modulation methods. A direct comparison of the two methods showed that they gave substantially the same result in height determination; and in a paper published in 1931, E. V. Appleton and G. Builder described certain important improvements in sending and recording technique which demonstrated the

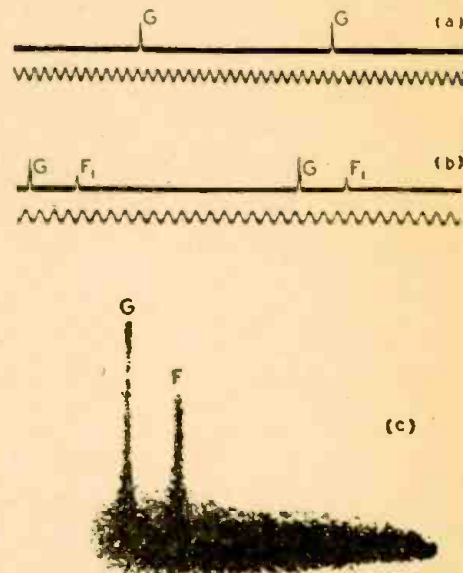

Fig. 8(a)—Records of ground pulses and timing oscillations. (b)—Same, with returned echoes. (c)—Same, photo of C-R screen pattern.

advantages and illustrated the possibilities of the pulse method, in so far as the signals arriving at the receiver due to the ground wave and successive reflected echoes could be separately received and recorded. At the sending station a tube oscillator  
(Continued on page 524)

### OUR COVER FEATURE "JAPANESE RADAR"

THE Japanese radar, which appears on our front cover this month, is a sequence from the Warner Brothers' film *Objective Burma*. This elaborate radar installation was located in the Northern part of Burma and a United States Task Force was charged with eliminating it. In the movie this mission was successfully completed and the installation blown up.

This fanciful radar, cooked up by the Hollywood technicians, looks most impressive in the motion picture and is supposed to let the public in on the sacrosanct wonders of radar—still suppressed by the Allied military authorities.

This particular Japanese radar installation was manned by two operators and was a revolving affair, the entire framework, transmitter, receiver, and operators rotating continuously.

Spectacular as it appears in the motion picture, modern radar installations do not look anything like this. Indeed, most modern installations are quite compact, probably not too many of the cumbersome revolving types being in existence today.

Nevertheless, the radar principle of transmitting microwaves, which are then reflected back to the operators, is correctly pictured for a not too technical public consumption.

Needless to say, the Hollywood technicians could reasonably well have shown a modern radar installation as it really appears, but in this they were prevented by military censorship.

# Future Aspects of Television

## Part II—Will We Have "Live" or "Canned" Television?

By DR. LEE D'FOREST

**E**MPHATICALLY it behooves the television set manufacturers to step to the front now and lift from the shoulders of the courageous telecaster the prolonged and ever-increasing financial burden. He will do this, not in the spirit of generous self-sacrifice, or camaraderie—but because his eventual profits will enormously outdistance those to be reasonably expected from the old sales plan.

If the set manufacturers, ALL of the set manufacturers, without a single daring exception, refuse to rent, we shall see, I greatly fear, an exceedingly slow growth of television. After the first flash of novelty wears off, those who have purchased the cheap, small-picture receiver, will lose their initial interest. Eye-strain and the total inadequacy of such pictures will not be long endured.

From these small pictures, moreover, television will receive a black eye. Invited neighbors who have viewed the miniscule show won't be inclined at once to rush to the nearest sales office for duplicate sets. And the yen to sign for the purchase of a respectable projection screen instrument won't be too compelling either, not only from the large cost involved but because the tiny pictures they have seen can give them only a wholly inadequate conception of what television in their own home *might* be.

Consequences: A very slowly growing television audience, a tendency on part of the watchfully waiting would-be sponsor to hold off from buying expensive time at telecasting studio; a resultant inclination by the station's backer to retrench on that program budget; further deterioration in public interest, fewer sales, lessened total hours of viewing. Result: general television stagnation—which would be little less than a national calamity.

No—this magnificent instrumentality *must* go forward, full speed ahead. And it is up to the manufacturers of television receivers to take the required step to insure that television shall go forward fast, and continue to grow fast—not flash, falter, and finally deteriorate. You must not sit advertizingly by and complacently expect the brave broadcaster to shoulder all the load. He can't do it, he won't do it, not for long: not if you won't take a little risk to swiftly speed the day of millions of screen sets in nightly employment. Rentals will do just this.

Mr. Manufacturer, the destiny of American Television is in your hands. You may rest assured that the Telecaster men will do their full share.

Now let's assume that all this has been done. John Q. Millions have signed three-month rental contracts, at \$2 per week, plus a \$20 fee for antenna and installation. They, family and neighbors, sit expectantly before a translux screen 24 by 32 inches in size. Appear in smooth succession a parade of glamor girls, some singing; beautiful music accompaniment. Then a 15-minute playlet involving 4 or 6 characters, all but the villain good looking, he handsome; a humorous ending. (Television must abound in laughs, be rich in humor, not cheesecake.) Next an entrancing travelog, entertaining and instructive. Followed by a trip through a helicopter factory, the main features of that craft illustrated, its mode of flight lucidly explained, ending with an irresistible

urge that Dad buy one of these skybuggies next summer. A commercial made so innocuous, so interesting that it is actually more entertaining than many a spectacle or play. For here is reality, real life directly applicable to your own.

For television offers the advertiser so rich a medium for telling his tale that no embellishment, no nauseating repetitions are needed—nor tolerable. What takes a minute by microphone can here be seen in a flash of light. The smart advertisers will sense this. Effective use of television advertising means a maximum economy of the viewer's time, a minimum drain on his interest. The smart sponsor will soon sense that in television he has at his careful disposal the most potent salesman in all history—radio or print are not in its class. But, as Robert Lee says in his excellent book, "Television: The Revolution":

"Cheap, lazy advertising methods will be the kiss of death to television. Sound radio has proved a hardy specimen despite a scrofula of spot-announcements and daytime-serial beri-beri. It has survived these all too frequent fits of commercial nausea, occasionally to say something fine and decent and worthwhile. And these occasional flashes of genuineness, out of a welter of sordid commercialism, seem to justify the system, although we may pray nightly for the growth of a more-than-microscopic commercial conscience.

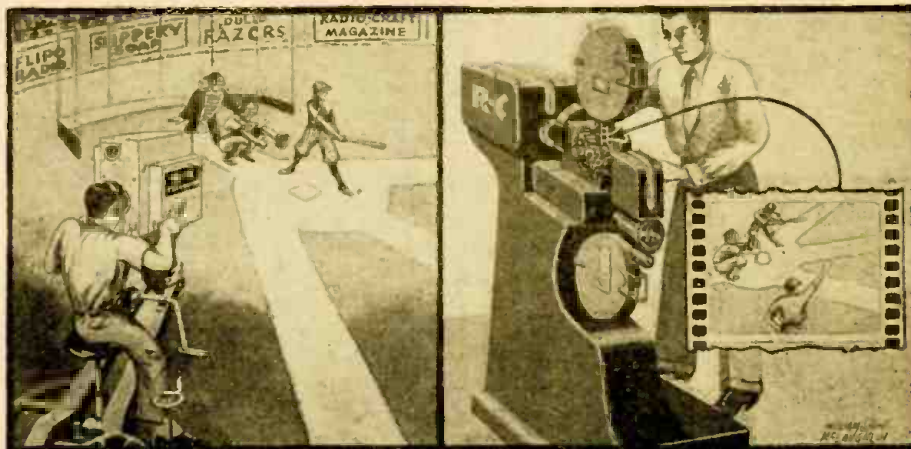

Authorities by no means agree that "canned (movie) shows" are equal to spot television. In the above drawing, the artist compares "live" and "canned" versions of the same action.

"Television, on the other hand, is not so robust a youngster as his radio brother. Video is much more sensitive. Sight audiences give much more attention than listeners to sound alone. Impressions reaching eye and ear simultaneously impinge more dominantly on the consciousness than what comes only from a loud-speaker. Most radio listeners have developed a cerebral relay, which automatically clicks off the attention when a commercial becomes boring. Not so television. The viewer must give most of his consciousness to the tele-screen; moronic commercialism will make him leave his receiver in disgust. It is apparent that video broadcasting has a digestive track which cannot stomach a plethora of cheap ads. Television will gag on Wheatsy-Flakes.

"Those two prize parasites—spot-announcements and hitch-hikes—have no place in visual broadcasting. For nothing will let the air out of the tires of the new industry more promptly than a spewing of spot-announcements. The 'station-break commercial' in an unashamed violation of the sponsor's trusteeship. The spot advertiser demands audience attention, but gives nothing in return. He's a chiseler. His message is a barnacle, sucking its hold on the programs which precede and follow it. The spot must go."

There will be small dissent, on any hand, to Mr. Lee's views; at least at present when our television babe is so spotlessly pure. Let us hope that as the child grows to adolescence it may be induced, or constrained, to avoid the previous sins which the author here outlines, so nauseatingly apparent to every radio listener throughout the land today.

But to return now to our television program. It has been on for a delightful hour. Another 15 minute drama followed a rollicking comedy. We have had a fleeting glimpse of how entertaining and pleasantly educational it may be made. There was not a fault in the acting, a single slip in the dialogue—every element of the entire program was in its exact place, the continuity perfect. Doubtless many hours of painstaking rehearsal were required to insure its 100 percent perfection. Such rehearsals now, are genuinely expensive. Good actors such as these are not picked up at a town hall meeting; their

salaries may total several thousand dollars. What a shame that all this effort, all this cost, is solely for a fleeting hour, finished now!

These plays can't be repeated, not in this community. Lacking a perfect chain hook-up this troupe of actors must now spend a day or two rehearsing their next show, or be transported to another distant studio for a repeat, and then on to another—old time tramping, or stock company stuff. But our audience won't be satisfied in seeing the same group week after week as in stock, nor can the same group appear oftener than once or twice a week, due to rehearsal-time demands. Hence in each television studio three or four groups of good  
(Continued on page 509)

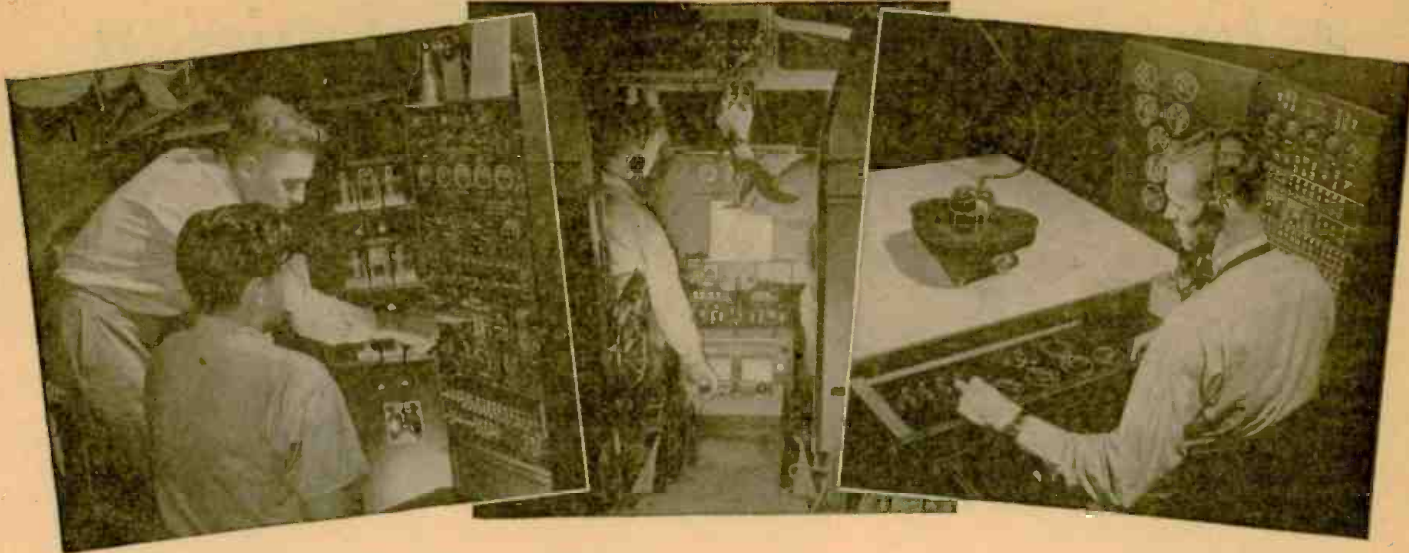

Instruction on the Flight Engineer's Panel. The Flight Trainer as viewed from the rear. Instructor sits here and manipulates "Crab."

# Electrons Train Aviators

Here is the story of the Navy's new operational Flight Trainer, which, it is reported on good authority, can make a 5-man crew for a PBM in something like 15 to 20 hours of instruction. Technical information on the trainer is now largely a military secret. Someday this will be released and those interested in such things can see just how this new marvel of electronic science operates.

By T. R. KENNEDY, JR.

**T**HE roar of mighty motors slugged into our ears. Small points of light on the flight-control panels cast an eerie glow over a dozen or more electric meters. Except for the faint gleam the cabin was dark.

"Steady as you go," a soft voice said, through the "intercom" system earphones we wore. "Give her a little more gas—you're off the ground now."

"God," exclaimed a girl just behind the pilot's chair, incredulously, "he said we're in the air."

The air-speed indicator climbed rapidly from 140 miles an hour to 210. A slight wiggle of the machine indicated bumpy atmosphere, heightening the illusion. Tugging at the controls, we "saw" the airplane come back to even keel.

Magically, somehow, we were actually "in the air." Every human sense told us so, even though the 10-ton mockup of the big PBM-3 of the Navy's Atlantic air transport service—the first "operational flight trainer" off the production line and now being seen and operated for the first time by outsiders; into which our party of newspaper men and women had climbed a few moments before—was as earth-bound as so much solid concrete.

We were, in fact, taking part in a unique demonstration to show exactly how the Navy now trains its 5-man PBM crews without sending them off the ground in an actual plane. Results have been revolution-

ary—no lives lost, no equipment smashed by inexperienced men, and millions of dollars and much time saved.

The demonstration had to be on Sunday because the Navy's training schedule was so full. Arriving at the base, our party was soon being divided into flight "crews" of 5 persons. Each crew was to be "given the works"—just like regulars undergoing training.

## AS BIG AS A HOUSE

The Navy's big PBM flight trainer is housed in a building as big as the average 5-room metropolitan apartment. It has everything for flight except wings and wheels. Its construction required more than a year by experts trained in a half-score of arts and crafts. The scene of its birth was a score or more of workshop-rooms in the Bell Telephone Laboratories, New York. The operational flight trainer was a brain child, of course, before it became a machine. It originated in the United States Navy's Bureau of Aeronautics special devices division, headed by Captain Luis de Florez.

Into its actual creation went more than 20,000 manhours of drafting, which resulted in more than 500 separate drawings comprising some 15,000 square feet of paper prints. Fifty complete sets of specifications were written up before one was adopted. The work went forward at the Bell Laboratories under the direction of project engineer R. C. Davis. Head of the work in the actual development was E. J. Kane.

Before beginning the actual development work, however, it was found necessary for all the laboratory men to become familiar with the principles of aerodynamics. Then they spent many hours deriving scores of special equations covering all the phases of actual flight, which in turn had to be resolved into practicable electrical circuits. The job was a huge one, but a simplifying factor was in their favor—the huge mockup

(Continued on page 534)

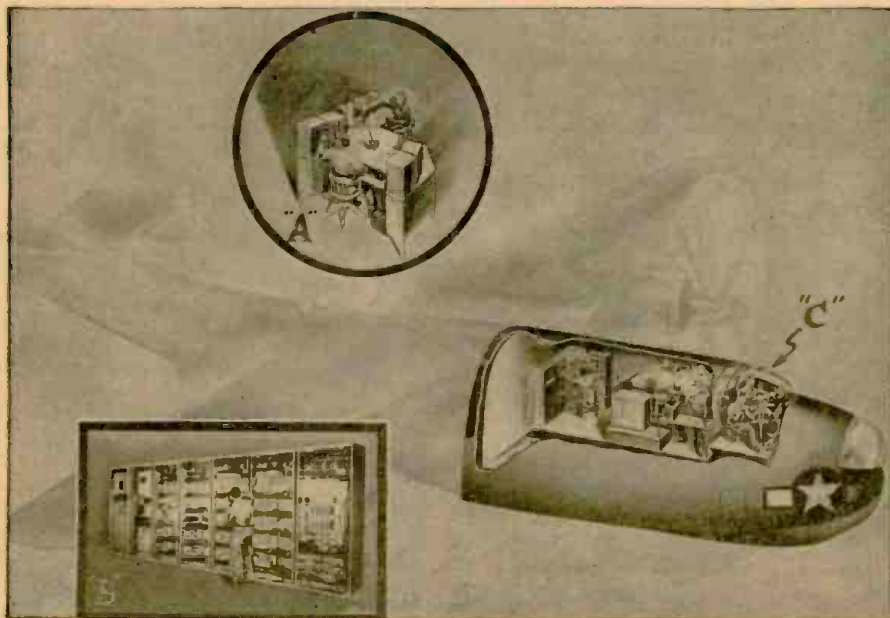

"A"—Instructor's control desk. "B"—Electrical computing apparatus. "C"—The trainer.



Photo 1—The 250-watt 118.55 Mc. Motorola transmitter. Lt. Ben Denby, at left of rack is using handset for monitoring during adjustment.



Photo 2—Mobile transceiver. The small converter unit is the little box on the sidewall at left. Photo 3—Aerial on the Dade County Courthouse is used for both transmitting and receiving.

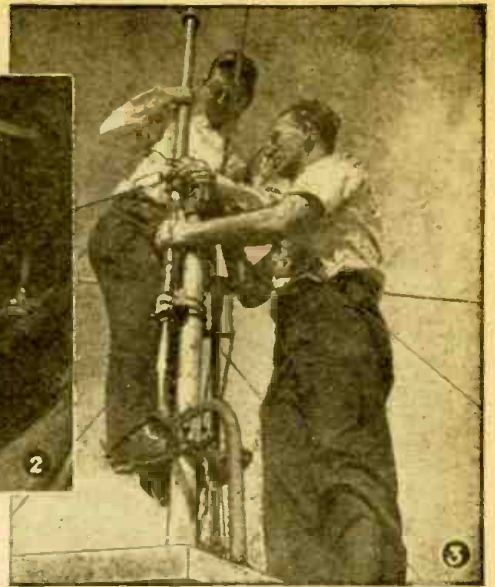

# POLICE RADIO ON V. H. F.

## Tests On 118.55 Mc Show Advantages Over Lower Frequencies

COMMUNICATION on 118.55 Mc. has proved to have a number of advantages for two-way police radiotelephone service. A series of tests have been conducted in Miami, Florida, by Lieutenant Ben Denby of the Police Radiotelephone service, using equipment designed and manufactured by the Galvin Manufacturing (Motorola Radio) Corporation, Chicago. The purpose of the experiments was an attempt to overcome the difficulties in two and three-way radiotelephone systems that have confronted practically every police department throughout the country using AM in the usual channels, or FM in the 30-40 megacycle channel.

These common difficulties are briefly:

- A. Long range skip interference from distant stations.
- B. The presence of static, both elemental and from human sources.
- C. Too long a length for the antennas on the mobile units. In many cases, this necessitated the omission of two-way radio for detective cruisers in order to avoid the conspicuous appearance of the usual transmitting antenna.

When Lieutenant Denby first declared his intention to utilize the 118 megacycle frequency, many electronic engineers were skeptical. Several predicted it couldn't be done. The waves would bounce off everything they touched. But from their long and successful experience with automatic relay stations in the 118 megacycle spectrum, Motorola Radio engineers took up the cudgels and designed and provided enough units to equip seven Miami patrol cars with mobile transceivers and one central control and one remote control station.

Both mobile and fixed station transmitters were of 15 watts power. The antenna for the central station was located on a telephone pole. After the preliminary tests showed successful results, in November 1944, the antenna was shifted to the top of the Dade County Courthouse, 345.9 feet above sea level. The 15 watt fixed transmitter was discarded and a newly designed transmitter of 250 watts was installed.

Here are the results of the exhaustive tests taken, operating on a twenty-four hour basis and in every kind of Miami weather.

1. On this frequency there is no skip interference apparent though over 40 relay stations in the United States operate on 118.55 megacycles. No bursts of any nature have occurred which would interfere with the operations or open the squelch.

2. Excellent operating efficiency is obtained with the 23 inch antenna. This length also obviates the hitherto encountered disadvantages of using the long length antenna for detective cruisers. There is no noticeable difference in either roof-top or side-top mounted antennas for reception up to 20 miles except that the side top antenna is less efficient for car-to-car talk and tends to exert a directional effect after two and one half miles.

3. Though there were always several dead spots when operating on AM in 2442 kilocycles or on FM when in the 30 to 40 megacycle band, none were encountered in the 118 megacycle spectrum. Mobile units were located in and between steel buildings, in basements of reinforced concrete and steel structures, in office buildings, under

ramps of various construction, under metal-roofed structures, inside wood, metal and concrete buildings fifteen miles from the main station, and also under power lines and transformer banks; in fact, anywhere and everywhere it was thought interference might result. In no case were there interruptions or loss of signal strength and operations were considered 100% satisfactory.

4. The signals definitely fade out at a certain distance depending on the power and antenna elevation.

5. Satisfactory car-to-car transmission is provided up to five miles though up to eighteen miles has been obtained on level ground.

6. Any operational changes that may have been created by the weather, hurricanes or other elements in Miami are not apparent in any of the tests or recordings made.

Lieutenant Denby is still conducting his experiments but has already reported to the FCC: "After actually seeing the operation as well as conducting these tests, we feel

(Continued on page 513)

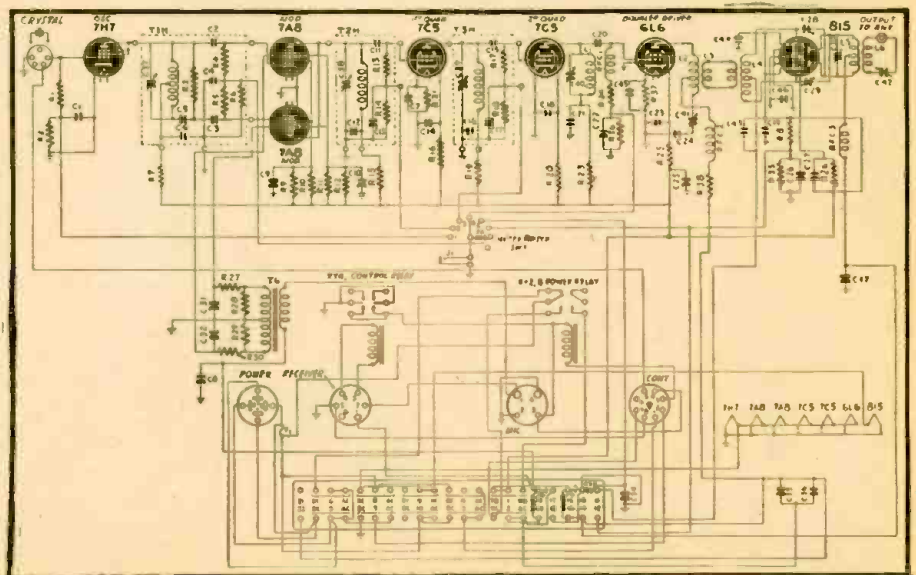

Courtesy Galvin Mfg. Co.

The transmitter used in the 118.55 Mc. tests. A photograph of the set is seen at left, above.

# Sound Units and Sound Ratings

By T. H. PHELAN\*

**T**HE basic unit applied to sound equipment such as Microphones, Amplifiers, and Loud-speakers is the *Deci-Bel*.

Since this is fundamental let us study its origin and value. In the early 1920's and before, losses or gains in telephone circuits, attenuators and amplifiers were expressed in miles of standard cable. As telephone facilities expanded it was found that measurements in terms of miles of standard cable was impractical. A new standard called the Transmission Unit, "T.U." was adopted in 1924. This unit approximately equalled the attenuation of one mile of standard cable but had an absolute value. One "T.U."

$$= 10 \log \frac{P_1}{P_2} \text{ or } 20 \log \frac{E_1}{E_2} \text{ where } P_1 \text{ and } P_2$$

or  $E_1$  and  $E_2$  are the input and output power or voltages of the system or amplifier under consideration.

A new standard called the "Bel" was adopted in 1929, as a tribute to Alexander Graham Bell. This is equivalent to ten Transmission Units. For practical applications it is too large a unit and one called the decibel (db) was adopted for general use. The value of one db is equal to a Transmission Unit. This today remains our basic unit of Transmission measurements.

Due to confusion between the major broadcasting companies and the telephone company in the measurement of levels and checking of "Program Peaks," a new unit of measurement called the Volume Unit, "V.U.," was adopted in the year 1939. Numerically one volume unit is equal to one

decibel. The term "V.U." is used only when measurements are made with a meter having the accepted electrical and dynamic characteristics defined by the volume unit standards. Use of this unit also denotes that all readings are referred to the zero V.U. basis of one milliwatt of power in a 600-ohm circuit.

From the above it can be seen that all three units, "T.U.," "db", and "V.U." are numerically equal.

Thus far our discussion of the various units has only been concerned with the purely electrical phases of the db. Each basic sound system has two electro-sound transducers, one at the beginning of the system and one at the end. At the beginning, a microphone is used to change the sound waves or energy into electrical waves or energy. At the end of the system a loud-speaker is used to change electrical energy into sound energy. Since we are changing types of energy, these units must be rated in a manner which will permit simple calculations of the overall sound system.

## ZERO REFERENCE LEVEL

The basic judge of sound is the human ear. It was logically decided to correlate the reference "zero level" point for sound computations with the characteristics of the average ear. Tests have been conducted which show that the threshold of hearing corresponds to a pressure of .0002 dynes per square centimeter. This reference point has been established as the "zero" level for sound measurements or computations. Increases in sound pressure above this point are expressed in db computed by using the formula previously mentioned. The same

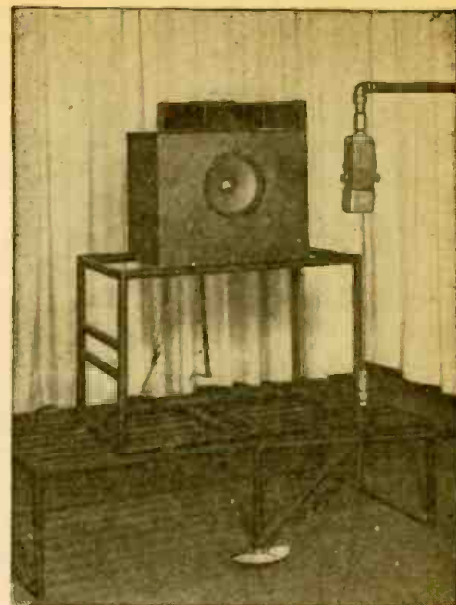

Speaker calibration. Note how microphone is swung to measure angular sound distribution.

reference level is used in expressing sound levels produced by a loud-speaker system. The electrical equivalent of this sound pressure zero line is  $10^{-16}$  watts per square centimeter.

A few typical sound levels will illustrate the magnitude of this zero sound level. The background sound level is approximately 35-40 db above zero level in the average living room of a suburban house. Ordinary conversations in the room would raise the sound level to a magnitude approximately 60 db above the zero. A sound about 130 db above zero level would be so loud as to cause a sensation of pain.

The minimum difference in levels which can be detected by a person under ideal conditions is one db. Under average conditions the level difference must be 3 db to become noticeable. The sound level must be increased approximately 10 db before it sounds twice as loud to the ear.

We must remember that doubling the power output of a sound system only increases the level 3 db and that if we wish to make it sound twice as loud we must increase the power by 10 db or ten times.

Now let us take the equipment which makes up a typical sound system and see how these ratings utilize the standard units discussed so far. The microphone is the first unit in the system and must be rated on a sound pressure input and an electrical output. A typical rating for a high fidelity microphone would be a sound pressure of 10 dynes per square cm. which will produce an output level of -55 db below a standard zero level of 1 milliwatt. The sound pressure of 10 dynes per square cm. is equivalent to a sound level approximately 95 db above the zero sound level.

The second unit in the system is the amplifier. Its amplification characteristics may be expressed in db of power gain or voltage gain. Because voltage gain expressed in db is the most convenient to measure and utilize in calculations, there is a trend to rate the gain of amplifiers on this basis.

The last link in our system is the loud-speaker. This is the point at which we convert electrical into sound energy. The efficiency and distribution characteristics will determine how much sound energy results from a given electrical input. The most useful type of rating on this unit is one which shows the electrical input in watts required

(Continued on page 515)

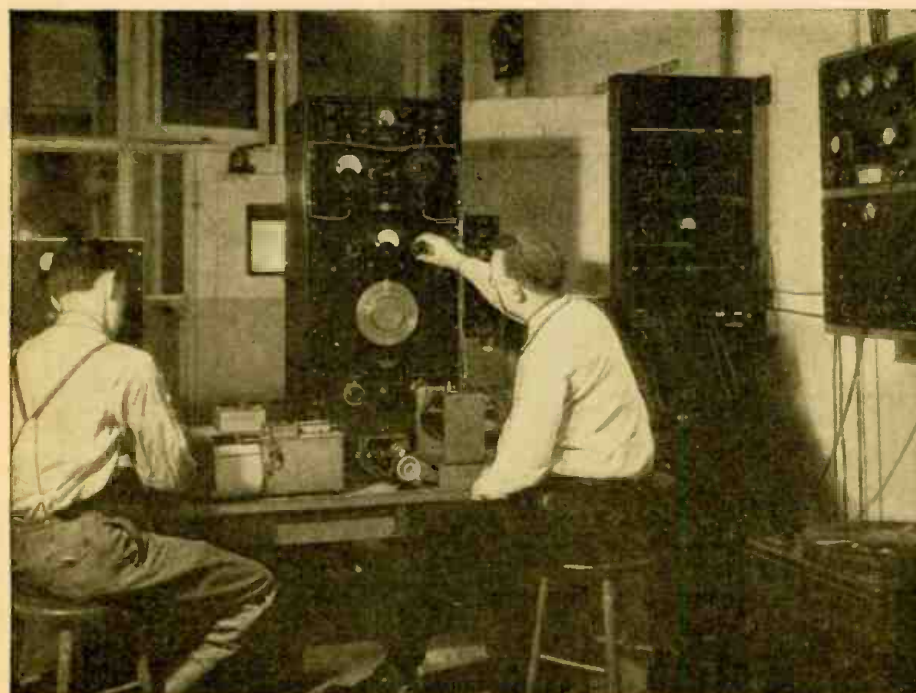

Photos Courtesy RCA

Signal generator and measuring equipment used for calibrating speakers and microphones



# VOLTAGE REGULATORS

By JACK KING

GOOD voltage regulation is important in many radio circuits. A radio transmitter's frequency may shift if the plate supply voltage swings. Changes in voltage may cause instability and oscillation in some receiving circuits. A few types of electronic instruments require supply voltages fixed as closely to the predetermined value as human ingenuity can achieve. This voltage regulation may be attained in three chief ways: by careful attention to apparatus used in construction of power supplies; by use of special voltage regulating and ballast tubes; and by the use of special power supplies with built-in circuits which act to oppose and neutralize any tendencies to change in the supply voltage.

A basic diagram of a source coupled to a load is shown in Fig. 1. If the source re-

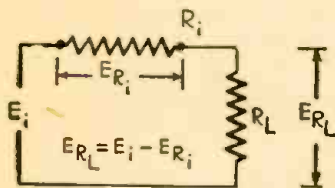

FIG. 1

sistance is kept very low, the voltage regulation will be good. With an incorrectly chosen source resistance, varying the load resistance between two limits above and below the resting value will mean an abnormally large swing in the current through  $R_i$  (internal resistance). The varying current flowing through  $R_i$  will produce a variable voltage drop across the source resistance. Since the output voltage is equal to the internal voltage minus the drop in the internal resistance, it will fluctuate too much. If  $R_i$  is very low in value, clearly the variation in potential across it will be low and the output voltage will be quite steady for reasonable changes in load resistance. This points to the desirability of low-resistance chokes and transformer windings in power supplies.

Voltage regulation may also be tied in with the storage of energy in a reactance. In a radio transmitter with the key open, the load resistance connected to the power supply in effect is made much higher in ohmic value and the load current is decreased. Referring to Fig. 2, the circuit

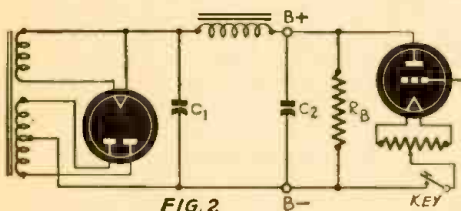

FIG. 2

current through the choke may be low in value with the key open. The output voltage across B plus and B minus is then high, and the filter condensers are charged up to high values of potential and store energy.

When the key is pressed, a load is put on the supply and the output voltage tends to drop. The choke's resistance causes power dissipation and reduction of output voltage. As the output voltage drops with increased load, it becomes lower than the potential of the output filter condenser.

Energy from this condenser is then returned to the circuit. Electrons flow from that condenser into the tube (the load resistance), tending to maintain the output voltage constant in value and thus serving as a voltage regulator. Ordinarily, we don't think of a condenser as a voltage regulator; yet, in reality, it may act as one. By using large values of C and L, not only the A.C. ripple can be reduced in compliance with the radio law and F.C.C. regulations, the voltage regulation can be improved, aiding in getting a "clean" note in radio code transmission.

The circuit of Fig. 2 may be simplified for our purpose into the circuit of Fig. 3. If a steady current is bled through  $R_i$  due to the presence of  $R_b$ , a steady voltage drop will be developed across  $R_i$ , tending to maintain the output voltage constant, since that output voltage is always equal to the internal source potential minus the voltage drop in the internal resistance  $R_i$ . Then, if the load resistance swings between reasonable limits above and below some normal resting value, the percentage change in current through and voltage across  $R_i$  will be relatively smaller.

In Fig. 2, a bleeder resistance  $R_b$  is connected across the output filter condenser and helps not only to stabilize the output voltage but also allows charges to leak off the condensers when the transmitter is not in operation, an important safety feature in high-voltage equipment. The same circuit may be used with a voltage regulator tube. The tube acts to maintain a constant voltage across the load. The regulator resistance is  $R_b$  and the load is  $R_L$ .

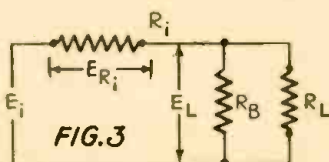

FIG. 3

In some radio receivers, a shunt resistance is used for voltage stabilization of the screen grid potential of a tube. A typical I.F. stage is shown in Fig. 4. Again the basic circuit of Fig. 3 applies. We substitute  $R_s$  for  $R_b$  and  $R_1$  for  $R_i$ . When the control grid of the tube (nearest the cathode) is made highly negative due to automatic volume control bias potential, the screen grid current decreases and there is a reduction in the voltage drop across  $R_s$ . A reduced drop across  $R_s$  would mean an increased screen grid potential at resonance. Rise in the screen potential is limited by the action of  $R_2$ . As the voltage across  $R_2$  rises, the current through it tends to rise. This increased current flowing in  $R_2$  and  $R_s$  will tend to produce an increased voltage drop in  $R_s$ , which works against any rise in voltage on the screen, providing a stabilizing action.

The series resistance of a supply may be made either very high or very low to secure a stabilized output voltage. In both cases, what is sought is a stabilization of the voltage across the element in series with the load circuit in order to obtain a stabilized output voltage, since the output voltage is the internal source voltage minus the drop in the internal resistance.

High-resistance supplies may be used with devices which draw very little current. By having more than 90% of the total circuit resistance in  $R_1$  (Fig. 1) any change in the load impedance can only have a 10% effect on the circuit as a whole.

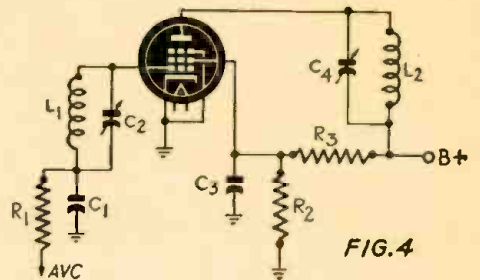

FIG. 4

In some communities trouble may be experienced due to excessive line voltage at certain times of the day. Tubes may fail in the receiver prematurely or may even be burned out. By putting a resistance in series with the line, a measure of protection may be gained. As the line voltage rises and the circuit current tends to rise, the increased current flow through the series protective resistance develops an increased voltage drop which subtracts from the line voltage applied to give the receiver working voltage. A special form of this regulator is the "ballast resistor." This is constructed to work on a critical point of its temperature-resistance curve. If current through it increases slightly its resistance rises greatly, thus holding down the voltage supplied to the load.

A more refined device is that of Fig. 5, which may be a part of an industrial control. A saturable reactor T is used. A bias potential  $E_c$  is applied to the grid of a control tube, and a certain amount of plate current, determined by the tube design, the bias, load impedance, plate potential, etc., flows through the winding  $L_1$ . The magnetic flux due to this D.C. current circulates in the core of the saturable reactor transformer T. As long as this plate current does not become too large, saturation and decreasing of the primary inductance  $L_2$  does not take place. When the line potential E rises, an increased signal voltage at the line frequency is applied through condenser  $C_1$  to the grid of the control tube,

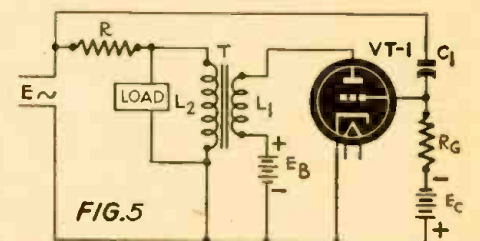
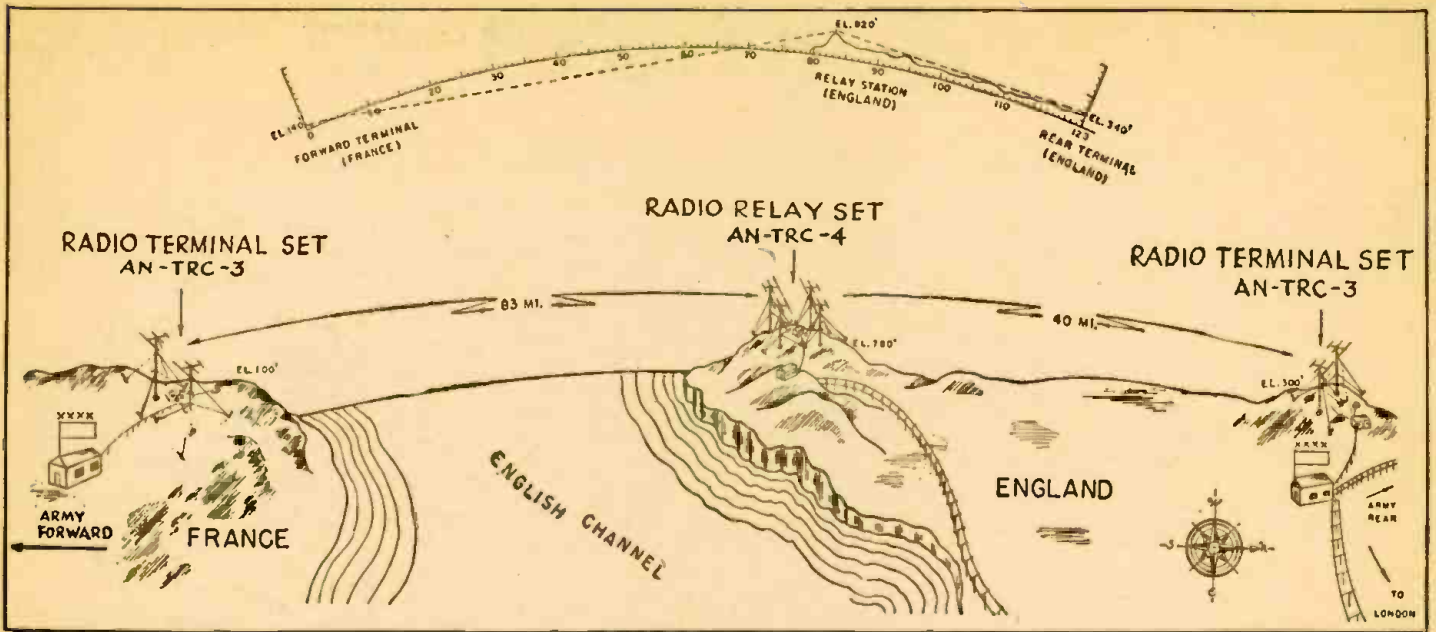

FIG. 5

which is so biased that any increase in signal voltage due to E will cause a linear rise in the current through the plate circuit and  $L_1$ . With increased D.C. current in  $L_1$ , the core flux rises and the core approaches saturation, causing a decrease in the effective inductance of  $L_2$  and the impedance of  $L_2$ . We have, in effect, a variable impedance connected across the load. Decreasing the value of the impedance reduces the load voltage and increasing it causes the

(Continued on page 521)



How the relay link sets were employed in the Normandy invasion. The central relay station is two terminal sets placed back-to-back.

# Army Radio Communications

**A**LTHOUGH the Army's basic policy considers wire to be the primary means of communication, and radio the secondary means, the very nature of this war with its highly mobile forces deployed throughout the world has placed ever increasing emphasis upon radio as the primary means for communications with highly mobile elements such as aircraft, tanks, amphibious vehicles and assault troops, or across enemy held territory and over water and terrain inaccessible to wire line construction. Radio must provide a degree of service comparable to that of a wire facility, including when necessary, the capability of being tied in with existing wire circuits to form one system giving the same grade of service as the wire system.

One of the outstanding developments of this war in Military Communications is the Army's VRF Radio Relay System which provides a true integration of wire and radio circuits into a single system or may be used as a separate system in much the same manner as the wire circuits.

The heart of this system is the broad band FM radio set, designated AN/TRC-1 developed by the Camp Coles Signal Laboratory of the Signal Corps Ground Signal Agency with the collaboration of the Link Radio Corporation. This set is capable of operation either as a terminal of a radio circuit or as an automatic radio relay set between the two terminals of a radio circuit in extending the overall communication

range beyond the distance range of an individual radio set.

It is used in conjunction with the Army's telephone "spiral-four" carrier cable system which provides the practicable terminal equipment whereby a radio circuit can be integrated with the wire circuit, or substituted therefor, in whole or in part, as the necessity dictates.

Fig. 1 shows a simplified functional diagram of a complete multichannel VHF radio relay communication system. The telephone and telegraph terminal equipment CF-1 and CF-2 is common to both the radio system and the "spiral-four" wire system. The radio terminal set is connected to its associated telephone terminal by "spiral-four" cable up to approximately 15 miles in length, one pair of the cable being used for transmitting and the other pair for receiving. The radio relay sets comprising in effect two radio terminal sets connected back-to-back are substituted for the telephone repeaters of a wire system. Duplex operation is achieved by the use of separate receiving and transmitting frequencies at each radio set.

Four telephone channels, each approximately 2800 cycles wide, within an audio frequency band of 200 to 12,000 cycles are obtained from the Telephone Terminal CF-1. Channel 1, operating at voice frequencies, is normally used as an order channel for intercommunication between terminals and relay sets for supervision and line-

up purposes within the system. Each radio set is equipped with filters to confine the order channel to the band 200 to 3000 cycles and prevent mutual interference with the carrier frequency channels. Ringing over the individual telephone channels is accomplished from field telephones or switchboards by the use of voice frequency ringers which provide a 1000-cycle tone modulated by the 20-cycle telephone ringer.

Tone teletype channels may be provided over any one telephone channel by the connection of the Telegraph Terminal CF-2 thereto. Additional teletype channels may be applied in like manner to other telephone channels. Facsimile service may be obtained by the use of Facsimile Equipment RC-120 on any one or more of the telephone channels.

The principal characteristics of the radio receiver and transmitter are: (1) a horizontal three-element antenna array comprising a driven dipole fed by a 50-ohm flexible solid dielectric coaxial transmission line and parasitically excited reflector and director dipoles, all adjustable in length to the operating frequency and supported on a mast head by a 40-foot sectional steel tube mast; (2) a 2500-watt, 115-volt, 60-cycle, gasoline engine driven generator.

A 250-watt radio frequency amplifier is available as auxiliary equipment for use with the 50-watt radio transmitter to in-

(Continued on page 520)

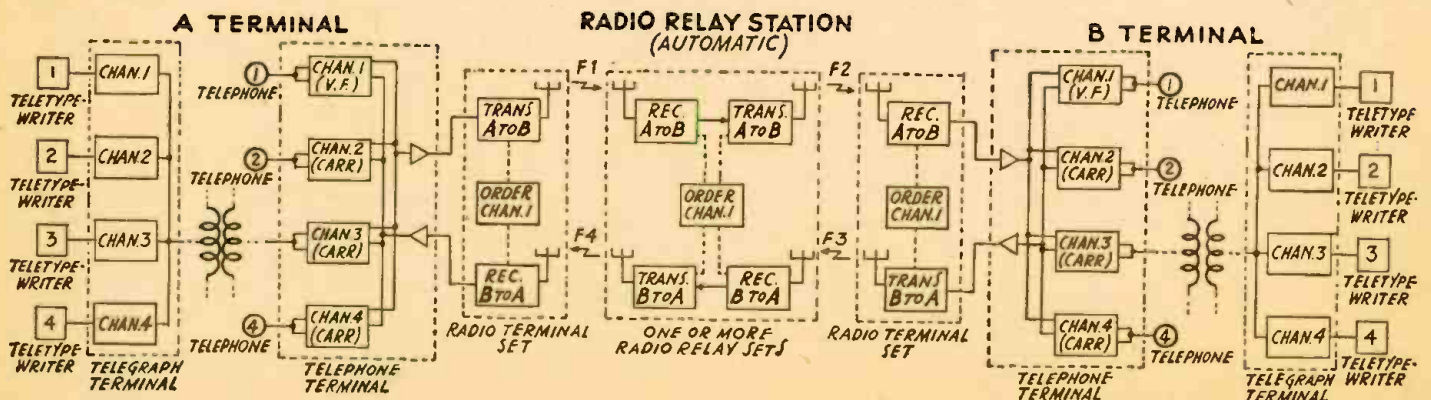

Fig. 1—A typical army network, in which wire lines, carrier channels and VHF radio circuits are combined in a large multi-channel system.

# SPEECH AMPLIFIERS

## Part VIII—Tone Compensators Using Tuned Circuits

By ROBERT F. SCOTT

THE tone controls previously discussed are inexpensive and simple to apply to almost any piece of audio equipment and may be utilized in very compactly built pieces of apparatus. It may be well to remember that the non-resonant circuit may be made to boost or suppress some portion of the audio spectrum but in no instance of boosting is it possible to exceed the value of amplification at the middle frequencies.

We are aware that when all factors are constant, the amplification of a vacuum tube amplifier varies directly as its plate load impedance. We can see that it is desirable to have some scheme by which the impedance may be made to increase with the frequency. This may be accomplished by the use of tuned circuits properly placed in the plate load.

It is common knowledge that a parallel or series tuned circuit may be made to accept or reject the frequency to which it is resonant. It is this factor which makes it applicable to tone control circuits. Unlike non-resonant circuits, it is possible to increase the gain at middle frequencies if it is desirable.

In the resonant circuits, there are three constants for each particular frequency. These are capacitance, inductance and resistance. The latter is equal to the D.C. resistance at audio and low radio frequencies but increases far above the D.C. value at ultra-high frequencies. The inductance and leads of the circuit will be the only factors to introduce appreciable resistance in the circuit.

Parallel and series circuits have characteristics which are entirely opposite but each has specific advantages for certain applications.

The series-tuned circuit is characterized by maximum current and minimum impedance at the resonant frequency. The magnitude of the current in the circuit is controlled by the value of the resistance.

The parallel-tuned circuit presents maximum impedance and voltage at the specific frequency to which it is resonant. This type of circuit is most commonly encountered in practice and will be discussed first, since it is probably the most easily recognized of the resonant circuits.

The voltage across such circuits is proportional to the impedance ( $E = IZ$ ), hence it is desirable to have a high ratio of inductance to capacitance (a high value of  $L$  and a low value of  $C$ ).

Fig. 1 illustrates how a parallel-tuned network may be connected in the plate circuit of an amplifier tube to increase the amplification at the resonant frequency of the network. At a frequency which makes the reactances of  $L$  and  $C$  equal, the impedance will be very high. Since this impedance is in series with the plate load resistor,  $R_L$ , the total plate load impedance may be considered as equal to  $R_L + R^2 + (X_L - X_C)^2$  where

$$X_L = 6.2832 \times f \times L$$

$$X_C = \frac{1}{6.2832 \times f \times C}$$

;  $6.2832 = 2 \pi$

At frequencies removed from resonance, the effective impedance of the network is reduced to such an extent that the plate load

impedance becomes equal to  $R_L$ . The value of  $R$  determines the sharpness and magnitude of the resonant peak voltage.

If  $R_L$  is considerably smaller than  $R_x$  and  $r_p$  in parallel

$$\frac{R_x \times r_p}{R_x + r_p}$$

the increase in amplification at resonance will be appreciable, hence this circuit is most efficient when applied to high mu triodes and pentodes.

Fig. 2 shows a circuit which may be employed to gain complete control of the frequency response characteristics of an amplifier stage. Thus it is possible to compensate for deficiencies in the response of a mike, pickup, speaker or specific acoustic conditions which are unwanted. This circuit has been found to give a wider range of boosting and control than is possible with some of the commercial types of tuned network controls.

This circuit is fundamentally the same as Fig. 1. In this circuit, there are three tuned networks. Two of these networks resonate on the high-frequency end of the audio range and the amplification at these frequencies is fairly constant up to 15,000 cycles. The remaining network is tuned to a frequency of 60 cycles and when a low "Q" choke is employed, the curve will be sufficiently broad to bring up the response to as low as 15 cycles. The values of the constants in these circuits are shown in the drawings. The sharpness of response may

be controlled by the presence of variable resistances in each of the tank circuits. For maximum boosting of the resonant frequency, the impedance of the circuit must be higher than the value of the plate load resistor.

The series resonant network consists of a condenser and inductance connected in series. The impedance is at its minimum value at resonance. As in the parallel tuned circuit, the sharpness of the circuit depends on the network's "Q". Such a circuit may be applied to the plate load resistor of a tube to compensate for the apparent low- and high-frequency losses when the radio or amplifier is being operated at low volume. An application of this principle is shown in Fig. 3. The plate load resistor is in the form of a potentiometer with its movable arm connected to the series-tuned network. This is tuned to the middle of the audio range, 1,000 cycles, and due to attenuation at this frequency, the highs and lows will be apparently boosted. The degree of attenuation will depend upon the setting of the arm on the plate resistor.

The series-tuned circuit may also be combined with inverse feed-back for tone control as shown in the fundamental circuit as shown in Fig. 4. We know that if a portion of the output voltage of an amplifier stage is fed back to the input in proper phase relationship, the original signal voltage will be reduced at the frequency of the feed-back voltage. In Fig. 4, the feed-back voltage is taken from the plate circuit and fed back to the cathode circuit. The amount of feed-

(Continued on page 523)

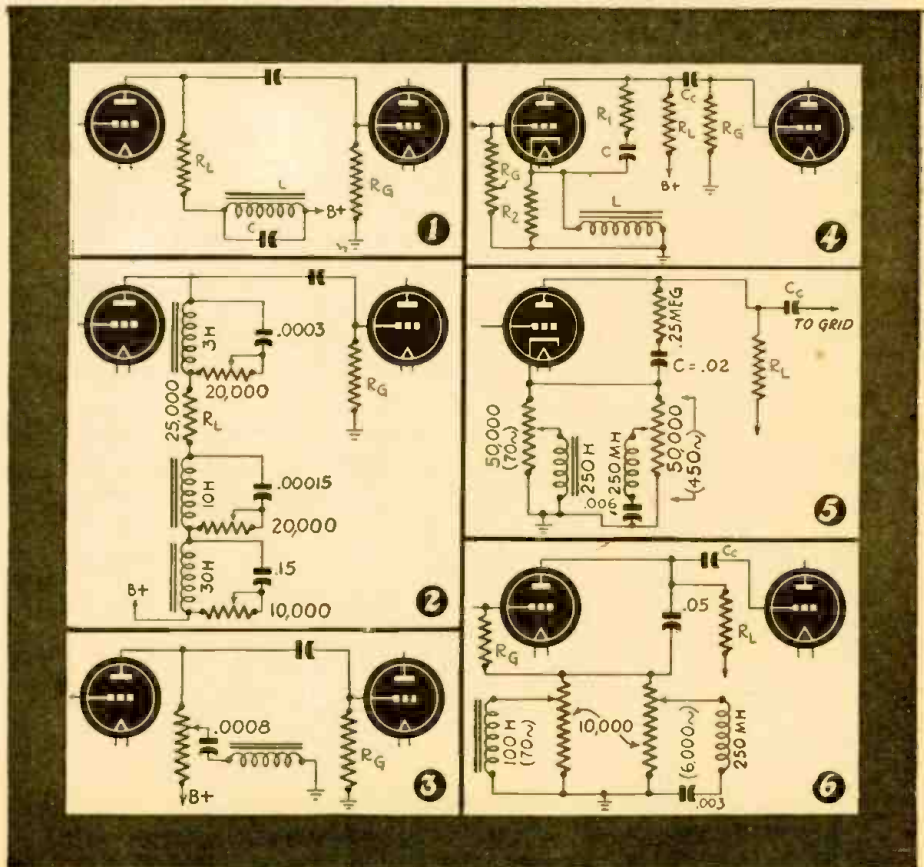

# RAPID CONVERSION

## Battery Receivers Can Be Changed Over Quickly and Profitably

By W. G. ESLICK

**M**ANY radio shops have on their shelves a number of the older types of battery sets. These can't be sold because they use so much battery power, and batteries are really hard to get! Due to the present scarcity of radios, they can now be sold if converted into fairly good A.C.-D.C. sets, and will convert a liability into a profit for the store.

We rebuild quite a few, mostly for outside stores. As they furnish all the necessary parts, our labor runs from \$7.50 to \$15.00 per set, and it doesn't take as long as one might think to convert a receiver. As an example, we rebuilt an Airline Model 67-377 in 4½ hours today. It used (original setup) a 1C7, four 1H4's, a 1D5 and a 1E5. In the new hookup, it has a 6A8, 6K7, 6Q7, 25L6 and 25Z6.

The later sets using octal 2-volt tubes are easier to work on and generally give better results than the older ones with 30's and associated 2-volt types.

First we must decide on what tubes to use. For the R.F. stage (if any) we have the choice of 6D6, 78, 6K7, 6SK7, and 39/44 (I have never tried the latter). For the converter a 6A7, 6A8 or 7A8 can be

used (By changing the oscillator coil we can use a 6SA7). We consider the 7A8 and 6D8 too valuable as replacements for the 12SA7 to use in this work. The 6K8 works, but with less gain than the above, and we don't want to lose any gain.

Regardless of the original circuit, we use a 75, 6Q7, 6SQ7 or a 7C6 as diode detector, AVC and first audio. For our power amplifier we use a 25L6. A 43 or a 25A6 gives about .9 watt output, while the 25L6 gives a little more than 2 watts, a worthwhile difference.

For the rectifier, a 25Z5, a 25Z6 or even two or three 76's tied together, enough to supply about 90 to 100 volts on the screen of the 25L6 with the set full on, through a filter choke or field of about 450 ohms.

There are other choices of tubes and circuits, and other ideas (such as a separate oscillator) but remember, we must rebuild these sets quickly, have a decent radio and use a minimum of parts new or used, if we are to make any profit. One of the stores buys sets for \$15 to \$20, spends about as much more for labor and parts and still makes a good profit on the sets.

Another point to remember is that the

audio must be high-gain, so we choose a diode-triode with a gain of 100.

If the set used a magnetic speaker, we must junk it. If a PM was used we may have to change output transformers if it would make a bad mismatch or if its resistance is so high as to cause a bad voltage drop to the 25L6 plate. If it becomes necessary to install a speaker, use a dynamic type with a field of not more than 450 ohms. This saves buying a filter choke.

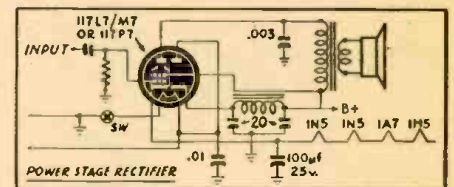

Fig. 2—A conversion which uses the 117P7

Now we are ready to change the set. First, cut the rivets holding the sockets of the old-type tubes and install new sockets to fit the desired tubes. If the set used octal sockets (and all contacts are on them) they are O.K. (Some sockets didn't have any contacts for the number 8 pin on octal sockets.) After the new sockets are in, take the wires off the old sockets and solder them onto the new ones. This saves time checking wiring.

As a rule, we can use a uniform circuit on all sets. (See Fig. 1.) There may be some special reason for departing from this in special cases, however. We use a 300- to 500-ohm resistor by-passed with a .05 mfd. condenser for the bias resistor of the 6A8 and 6K7 cathodes, which are hooked together. If the set has more than one R.F. stage or I.F. stage, then we use a 300-ohm resistor in each tube. For the diode and 1st A.F. we usually ground the cathode and use a 5- to 15-megohm resistor or a bias cell in the grid circuit. For the 25L6, a 150-ohm 5-watt resistor and 25-mfd., 25-volt condenser supply the bias.

The filaments are wired in series, with the 6A8 wired to the 6Q7 and the other end of the 6Q7 filament going to ground. We like to keep these filaments as near ground as possible. We use a line cord, but a ballast tube can be used. An experimenter converting a set for his own use may use a 110-volt light bulb of correct wattage.

Don't forget to use a condenser (.001 to .006 capacity) from the 25L6 plate to prevent audio howls and squeals. A .01-mfd. condenser from the rectifier plates to ground will prevent tunable and other hum.

We use the chassis as a return "ground" for all circuits. When doing this, use a .01 condenser in series with the antenna lead and paste a label on the set warning against using a ground. Pilot lights and tone controls are a matter of taste and may be adapted to the particular set.

If oscillation occurs, isolate the B-plus leads to each individual plate circuit through a 1,000- to 2,500-ohm resistor and by-pass with a 0.1-mfd. condenser. We have never run into serious oscillation trouble yet, but keep our fingers crossed.

(Continued on page 507)

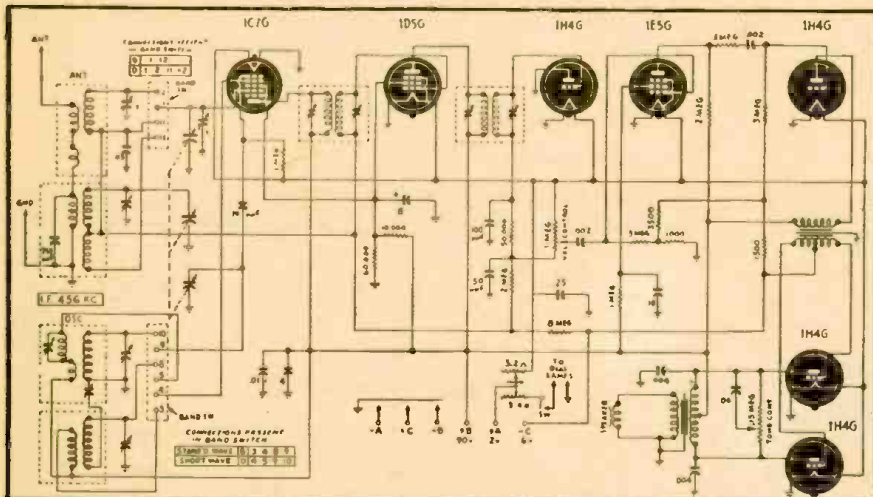

The original Airline 67-377 which was made into the satisfactory A.C.-D.C. model below

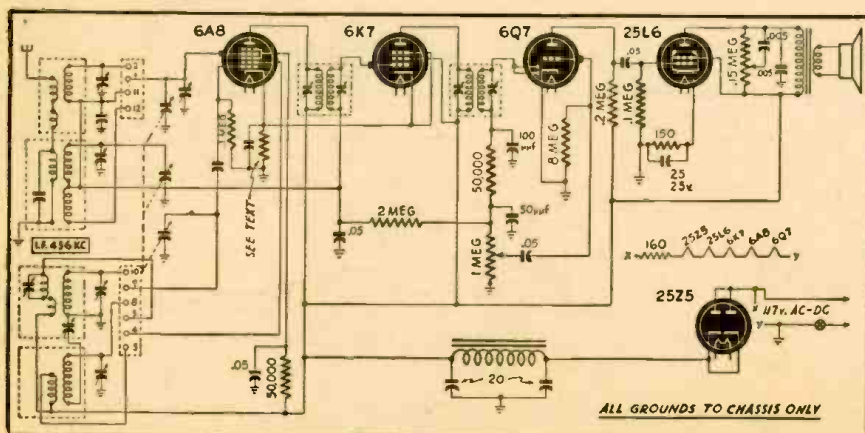
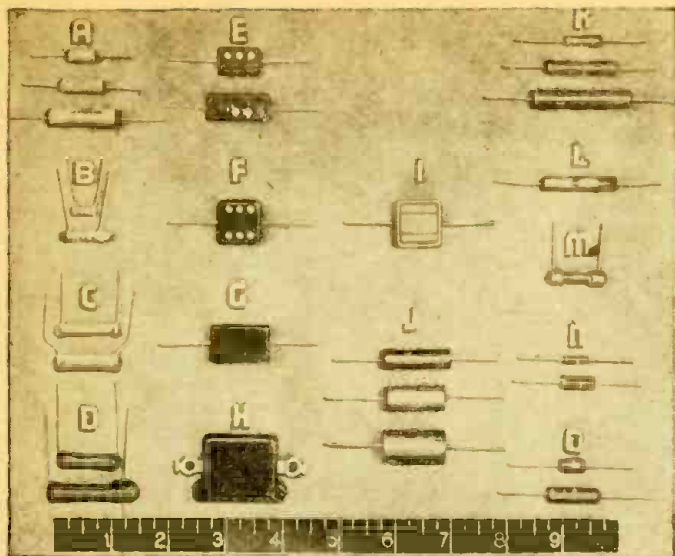

Fig. 1—Standard 6-volt tubes and a few circuit changes make the Airline an electric set

# Capacitor and Resistor Codes

By STUART DISTELHORST



A-D are ceramic, E-H mica, and I, J, ceramic capacitors. K to O, are carbon resistors.

ONLY occasionally do smaller capacitors and resistors have their numerical values marked, stamped, or printed on them. The trend toward reduction in size and weight of these individual components themselves, as well as the operating units into which they are assembled, has resulted in capacitors and resistors of such microscopic size that coding systems have had to be adopted to provide a continuously legible indication of their electrical values. Several codes are in current use and it is the purpose of this article to clarify the minor differences between the various codes. All of these codes are based on separate colors representing each of the individual ten digits as follows:

- |          |          |
|----------|----------|
| 0—black  | 5—green  |
| 1—brown  | 6—blue   |
| 2—red    | 7—violet |
| 3—orange | 8—gray   |
| 4—yellow | 9—white  |

Gold and silver are sometimes used to indicate decimal multipliers of one-tenth and one-hundredth of the values indicated by the non-metallic colors, as well as approximate tolerances of five per cent and ten per cent of rated electrical values. Additional specific values are assigned to these metallic colors by the various color coding systems.

## BASIC THREE-DOT COLOR CODE

The basis of the three-dot color code for mica capacitors is a series of three colored dots which indicate the capacitance in micromicrofarads (mmf)\*. Auxiliary colored dots are sometimes added to indicate the voltage rating, temperature coefficient, and tolerance in percent of rated capacitance. An arrow or other device is ordinarily molded or stamped on the case of the capacitor to indicate the sequence in which the dots are to be read. The first two dots show the first two significant figures of the capacitance in micromicrofarads, while the third dot indicates the number of zeros to be added. A gold or silver third dot indicates that the mmf-value shown by the first two dots is to be divided by 10 or 100, respectively.

**EXAMPLE:** A 0.006-mf (6,000-mmf) capacitor is marked by three dots in sequence as follows: blue (6), black (0), and red (00).

The dot indicating tolerance, when used, is usually located above or below the third

(number-of-zeros) dot. The color of the tolerance dot corresponds to tolerances between plus-or-minus 1 per cent and 20 per cent. Gold and silver are added to the basic color code to indicate tolerances of approximately 5 per cent and 10 per cent, respectively. Thus, either green or gold may be used to indicate a tolerance of 5 per cent. Similarly black, normally indicating zero, and the leaving of this dot blank so that it appears the same color as the body of the capacitor, both indicate the highest tolerance: plus-or-minus 20 per cent.

The voltage dot, when used, is located above or below the first capacitance-value dot. The various colors denote the direct-current working voltage. When no color is indicated, the voltage rating may be as low as 300-volts. Omission of both of the auxiliary dots is made for capacitors having maximum tolerance and a D.C. working voltage rating which is the lowest used for that type and size of capacitor.

TABLE I. BASIC THREE-DOT COLOR CODE.

Color	First Dot	Second Dot	Third Dot	Tolerance	Voltage
Black	0	0	none	20%	*
Brown	1	1	0	1%	100
Red	2	2	00	2%	200
Orange	3	3	000	3%	300
Yellow	4	4	0.000	4%	400
Green	5	5	00.000	5%	500
Blue	6	6	000.000	6%	600
Violet	7	7	0.000.000	7%	700
Gray	8	8	00.000.000	8%	800
White	9	9	000.000.000	9%	900
Gold	*	*	divide by 10	5%	1,000
Silver	*	*	divide by 100	10%	2,000
(body)	*	*	*	20% (lowest)	

\*not used.

## RMA CODE FOR MICA CAPACITORS

The RMA code uses six colored dots with an arrow to show the sequence. Greater accuracy can be obtained than that provided by the basic color code because the

first three dots give the first three significant figures of the capacitance in micromicrofarads and the fourth dot, directly below the third, the number of additional zeros. The fifth dot indicates the tolerance in capacitance and the sixth, the working voltage. This code also differs from the previously described basic code in that a body-color voltage dot indicates a minimum D.C. working voltage of at least 500-volts.

**EXAMPLE:** A capacitor of 0.006-mf (6,000-mmf) plus-or-minus ten per cent, 800-volts D.C. working voltage, is marked as follows: blue (6), black (0), black (0), brown (one additional zero), silver (10%), and gray (800-v) in that order.

TABLE II. RMA SIX-DOT COLOR CODE

Color	First Dot	Second Dot	Third Dot	Fourth Dot	Fifth Dot	Sixth Dot
Black	0	0	0	none	*	*
Brown	1	1	1	0	1%	100-v
Red	2	2	2	00	2%	200-v
Orange	3	3	3	000	3%	300-v
Yellow	4	4	4	0.000	4%	400-v
Green	5	5	5	00.000	5%	500-v
Blue	6	6	6	000.000	6%	600-v
Violet	7	7	7	0.000.000	7%	700-v
Gray	8	8	8	00.000.000	8%	800-v
White	9	9	9	000.000.000	9%	900-v
Gold	*	*	*	divide by 10	5%	1,000-v
Silver	*	*	*	divide by 100	10%	2,000-v
(body)	*	*	*	*	20%	500-v

\*not used.

## AMERICAN WAR STANDARD CODE

The AWS code for molded mica capacitors, like the RMA code, makes use of six colored dots but with somewhat different significance. The first four dots give the capacitance in micromicrofarads in the same manner: first significant figure, second significant figure, third significant figure, and the number of zeros. Like the RMA code, the fourth dot is located under the third or last dot in the top row. Currently none of the capacitors standardized under the AWS code requires more than two significant digits to specify its capacitance. Therefore, the first dot is always black on all molded mica capacitors marked with the AWS code; the two necessary significant figures are given by the second and third dots. As a result, the black first

(Continued on following page)

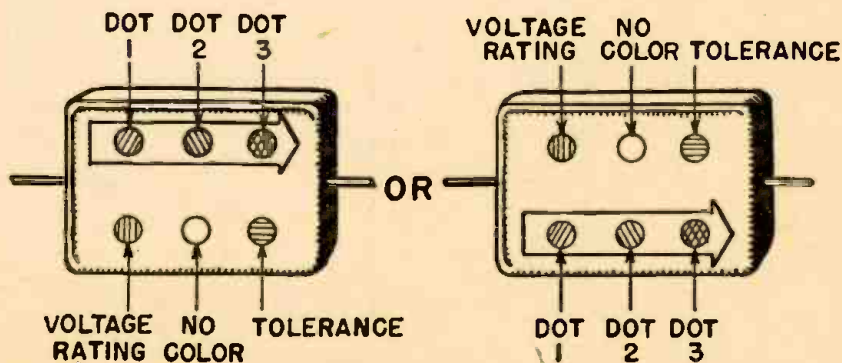

Basic 3-dot color code provides working voltage and tolerance indications. See Table I.

\*Reference: Graphical Symbols for Telephone, Telegraph, and Radio Uses, approved October 24, 1944, by American Standards Association: Micromicrofarads—mmf

dot becomes an important feature or identification symbol for a molded mica capacitor marked according to the AWS code.

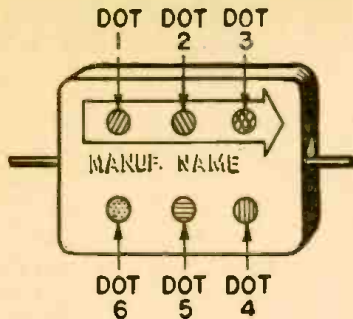

RMA six-dot code, explained in Table II.

EXAMPLES: A 0.00012-mf (120-mmF) capacitor is marked, to indicate its value, as follows: black (0), brown (1), red (2), and brown (one additional zero).

A 0.0091-mf (9,100 mmF) capacitor is marked as follows: black (0), white (9), brown (1), and red (00).

Note that in each instance the first dot is black (0).

The fifth dot in the AWS color code indicates the capacitance tolerance in per cent of rated capacitance as previously described. The sixth dot, introducing a new factor, denotes characteristics of design involving Q-factors, temperature coefficients, maximum drift limitations, and production test requirements.

It will be noted that this color code does not include the voltage rating. This is considered unnecessary since, with few exceptions, all capacitors marked with the AWS

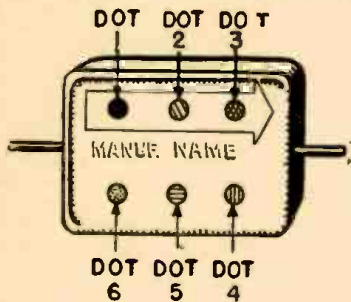

AWS code. First dot is always black. Fourth and sixth dots are explained in Table III.

color code are rated at 500 D.C. working volts. The exceptions, all of which are rated at 300-v, are (1) AWS type CM35 capacitors with capacitances of 6,800-mmF, 7,500-mmF, and 8,200-mmF; and (2) AWS type CM40 capacitors with capacitances of 9,100-mmF and 10,000-mmF.

TABLE III. AWS SIX-DOT COLOR CODE FOR MICA CAPACITORS

Color	1st Dot	2nd Dot	3rd Dot	4th Dot	5th Dot	Sixth Dot
Black	0	0	0	none	20%	No specified qualities.
Brown	*	1	1	0	*	Specified "Q".
Red	*	2	2	00	2%	Temperature coefficient: plus-or-minus 200 parts/million/C°.
Orange	*	3	3	000	*	Temperature coefficient: plus-or-minus 100 parts/million/C°.
Yellow	*	4	4	*	*	Temperature coefficient: 0 to plus 100 parts/million/C°.
Green	*	5	5	*	*	Temperature coefficient: 0 to plus 50 parts/million/C°.
Blue	*	6	6	*	*	Temperature coefficient: 0 to minus 50 parts/million/C°.
Violet	*	7	7	*	*	
Gray	*	8	8	*	*	
White	*	9	9	*	*	
Gold	*	*	*	divide by 10	5%	
Silver	*	*	*	divide by 100	10%	

\*not used.

### AWS PAPER CAPACITOR CODE

Fixed paper-dielectric capacitors of the home-receiver replacement type have their values printed on them together with an indication as to which lead is connected to the outer foil and, therefore, might best be grounded. No color coding of capacitance values is used with capacitors of this type.

The AWS code for molded paper capacitors, like the code for mica capacitors, uses six colored dots together with an arrow to indicate the proper sequence. Units marked according to this system can be identified readily by the fact that the first and fifth dots are always silver. The second

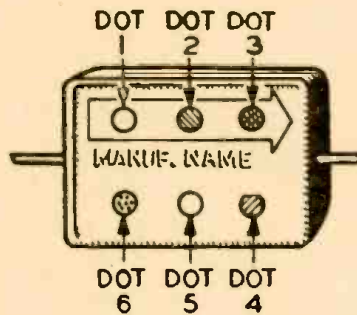

AWS paper capacitor code. First and fifth dots are always silver, sixth black or brown.

and third dots give the first and second significant figures while the fourth indicates the number of additional zeros to give the capacitance in micromicrofarads. The sixth dot shows whether the capacitor has a maximum operating temperature from minus-67° to plus-167° (brown) or plus-185° (black).

No indication of working voltage is given by this color code. However, all AWS molded paper capacitors have D.C. working voltages between 300-v and 800-v. The lower rating applies to units with high-capacitance ratings and the higher voltage rating applies to units with low-capacitance ratings.

### TUBULAR CERAMIC CAPACITORS

Tubular ceramic dielectric capacitors may be marked according to either an AWS or an RMA color code. The temperature coefficient is indicated by the color of the band or dot at one end of the unit. Capacitance in micromicrofarads is shown by the first three succeeding dots to two

significant figures plus the number of additional zeros in the usual fashion. The capacitance tolerance, in per cent of rated capacitance for capacitors of greater than 10-mmF or tenths of a micromicrofarad for capacitors of less than 10-mmF, is indicated by the last dot.

EXAMPLE: A 30-mmF plus-or-minus 5% capacitor with a temperature coefficient of 80 parts per million per degree Centigrade would be marked as follows: end band or dot, red (80 parts/million/C°); second color, orange (3); third color, black (0); fourth color, black (no additional zeros); and fifth color, green (plus-or-minus 5%).

The symbol (negative) indicates that the capacitance varies inversely with temperature. The temperature coefficient is expressed in micromicrofarads per microfarad per degree Centigrade. Some capacitors are marked with a numeral instead of a color code. For example, N-030 represents a negative temperature coefficient of 0.00003-mmF/mF/C°.

### FIXED RESISTORS

Small fixed resistors, of both composition and wire-wound types, are frequently marked with colored bands and dots to indicate the resistance and tolerance. An RMA and an AWS color code are both in general use. The two codes are not identical in all particulars but are similar in many respects. In all cases the various color combinations of body, ends, bands, or dots indicate the resistance in ohms to two significant figures, the number of additional zeros, and the per cent tolerance in resistance.

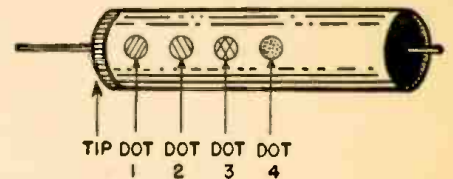

The RMA code for tubular ceramic capacitors.

The first method makes use of four colored bands, starting at one end of the unit, to show resistance and tolerance. The bands, reading from the colored end, indicate (1) first significant figure, (2) second significant figure, (3) number of additional zeros, and (4) per cent tolerance. The body color (Continued on page 497)

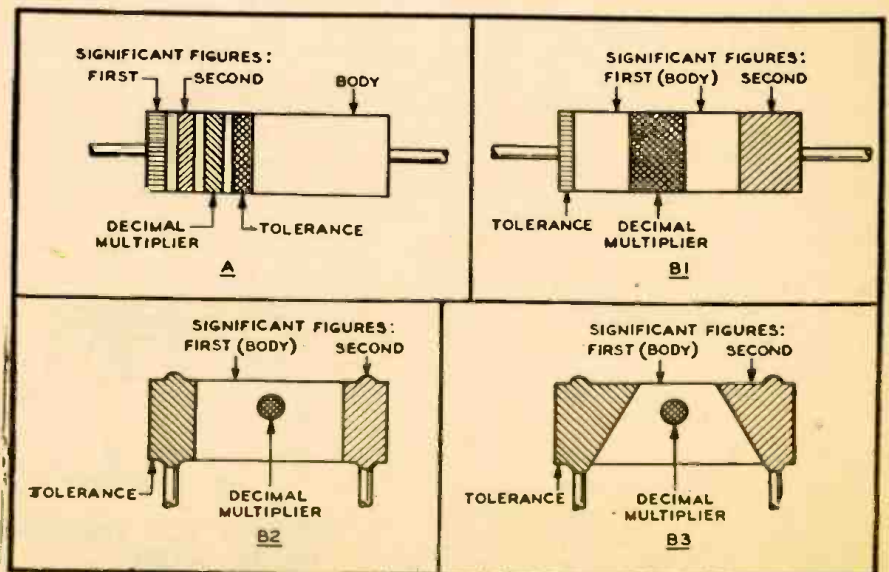

Resistance markings as used by both RMA and AWS codes. Note that body color is not part of the code in A—in the others, body color is one of the significant figures.

# BROADCAST EQUIPMENT

## Part VIII—CLASS-C AMPLIFIERS

By DON C. HOEFLER\*

**T**HE Class C amplifier is used almost exclusively in broadcast transmitter applications because of the numerous advantages which it offers. It may be used as a linear power amplifier, a modulated R.F. amplifier, or as a frequency multiplier (harmonic generator). However, operation must be confined to the R.F. stages since relatively high excitation voltages are required and the output wave-form exhibits a high degree of distortion. It differs from other tuned amplifiers in that it operates with a grid bias which is appreciably greater than (1½ to 4 times) the cut-off value.

The Class C amplifier has exceptionally high efficiency, as a result of the fact that plate current flows only when the instantaneous voltage drop across the tube is low; i.e., the plate current is zero when no alternating grid voltage is applied, and plate current flows during much less than one-half of each cycle when a signal voltage is applied. These very short pulses of plate current exhibit several important characteristics; as the pulses become shorter: (1) Efficiency becomes greater; (2) Input power and consequently the output power becomes less; (3) Harmonic components of the plate current become greater.

This last factor enables the circuit to be designed as a frequency multiplier, for considerable output may be obtained from suitable tubes at several integral multiples of the excitation frequency. This is accomplished simply by tuning the output tank circuit to the desired harmonic frequency.

Thus it can be readily understood that the output wave-form of a Class C amplifier

For unmodulated Class C R.F. stages, the bias should be about twice cut-off. In plate-modulated Class C stages, the value of grid bias should be somewhat greater than cut-off at the highest plate voltage encountered. Experience has shown that a desirable value is about three times cut-off. For purposes of economy and good regulation, grid-leak bias is often employed. This has a particular advantage in plate-modulated Class C amplifiers, as it materially reduces the high grid current and driving power which are required because of over-saturation at normal plate voltages. Then without modulation a small degree of increase in grid current will add to the bias and thereby lower the undesirably high positive grid swing. When the plate voltage increases due to a positive modulation peak, the grid current lessens, reducing the bias and increasing the positive grid swing. For this reason experiment has proved that better modulation is obtained with grid-leak bias than with fixed bias.

Grid-leak bias when used alone has a disadvantage in that it disappears with the loss of excitation. Therefore, regardless of the source of Class C bias employed, a resistance in series with the cathode should always be provided to safeguard against the complete loss of bias. Then as long as plate current flows a minimum safe value of self-biasing is provided. If the independent bias should fail and this cathode resistor were not provided, the plate current would immediately rise to dangerously high proportions, possibly causing irreparable damage to the tube.

### THE DOHERTY AMPLIFIER

The high-efficiency linear power amplifier is a result of efforts of W. H. Doherty, of the Bell Telephone Laboratories, to reduce the expense of operating power for the amplitude-modulated stages of broadcast transmitters, particularly of 5000 watts and over. Maximum efficiency is obtained from any vacuum-tube power amplifier only when the tube is delivering the maximum possible R.F. voltage into its load. However, since this maximum voltage is delivered only during infrequent and momentary peaks of amplitude modulation, and the unmodulated carrier voltage is but one-half of this maximum value, the average plate power efficiency of such stages ranges from 30 to 35%. When considering the entire system from power mains to output tank, the overall efficiency may range from 20 to 25%.

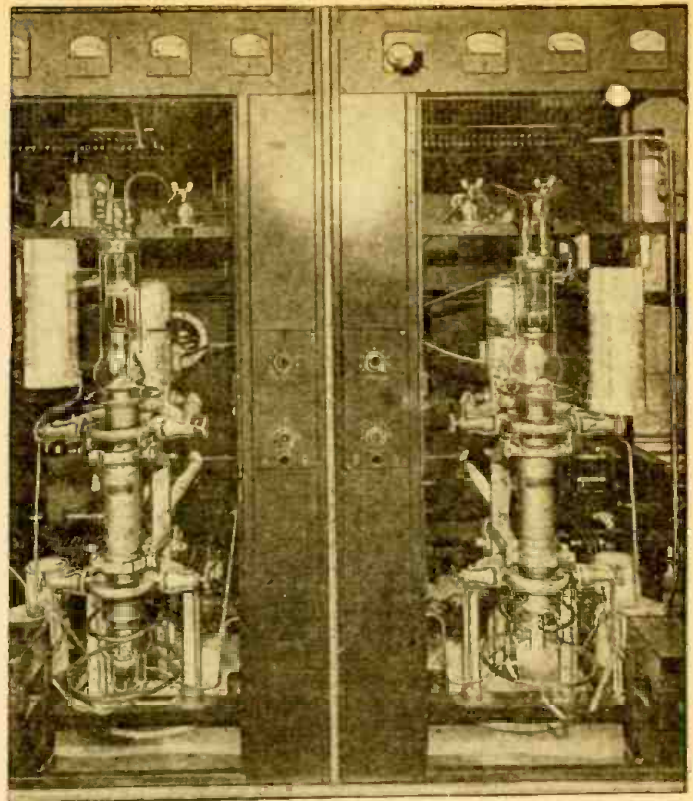

Photo Courtesy Western Electric

The power amplifier of Radio WLAC, employing Doherty circuit.

The Doherty circuit provides a plate power efficiency of 60 to 65%. To understand its basic principle of operation, we may draw an analog by reference to an electric power system. If we have a generator delivering electric power into its load under conditions of maximum efficiency and additional voltage is required, we can merely insert another generator in series with the first at the times that additional output is needed. While it is not possible to operate vacuum tubes directly in this manner, the Doherty circuit permits exactly the same effect to be accomplished by connecting the tubes in *parallel* and causing their outputs to be in *series*.

This may be understood by reference to Fig. 1. The excitation voltage  $E_s$  divides into two parallel branches. In the upper section, the voltage undergoes a phase shift of  $-90^\circ$  in the grid circuit before it is impressed upon the control grid of the carrier amplifier tube. The voltage is then amplified and further shifted  $180^\circ$  as it passes through the impedance-inverting network where its phase is again retarded  $90^\circ$ . Thus the resultant voltage has rotated  $360^\circ$  and is in phase with the exciting voltage.

In the lower branch of the circuit, the signal  $E_s$  is shifted  $-90^\circ$  in the phase-shift network,  $-90^\circ$  in the grid circuit, and  $180^\circ$  in the peak amplifier tube, whence it also emerges in phase with  $E_s$  and combines *additively* at  $E_o$ . This apparently brings us right back where we started, but not without accomplishing our original purpose. The carrier amplifier is so adjusted that it is approximately fully loaded when no modulation is applied. Thus the plate current can follow the negative modulation peaks, but cannot follow the positive alterations due to saturation. The peak amplifier is so biased that it does not begin delivering power until the excitation exceeds the unmodulated value. Thus its plate current is capable of following the positive modulation alternations but not the negative

(Continued on page 517)

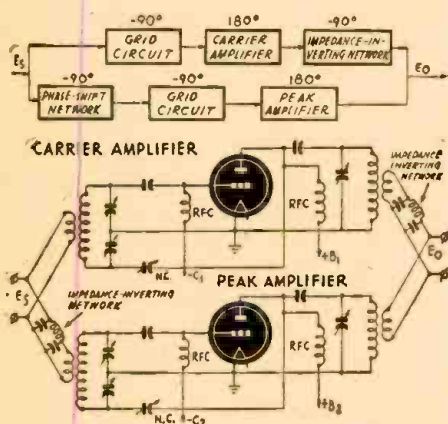

Fig. 1—The Doherty high-efficiency amplifier.

is very complex and contains large harmonic components. Nevertheless, the output voltage may very nearly approach the sine-wave condition, due to the "flywheel effect" of a properly-designed tank circuit, as previously explained in the discussion of the Class B circuit. Under this condition, the output voltage is  $180^\circ$  out of phase with the exciting voltage.

\*Broadcast Engineer, ex-W2XMN (F.M.), Alpine, N. J.

# Test Comparator

A High-Speed Checker for Production

By WM. F. FRANKART

THE Comparators described below were designed for use in factory production testing. Because of their speed of operation they will be found excellently adapted to such work. For the small laboratory or service shop they may be calibrated to serve a number of purposes, such as "Q" meter or signal generator.

One of the units is a variable-frequency device for checking radio-frequency coils and all types of condensers. The second is a "production type" adaption of the first. The third is designed for checking iron-core components such as audio transformers, power transformers, chokes and filters. Used in production, they can save many man-hours of test time. For the smaller producer or serviceman, the three pieces compose almost a small laboratory and will answer many problems in which accurate checking has been unattainable because of the high cost of such equipment.

As can be seen in Fig. 1, the first instrument is a grounded-plate Hartley oscillator using a 6SJ7 tube, with a 6N7-G (elements paralleled) as a cathode follower. The vacuum-tube voltmeter section employs a 6F5 and a 200-micro-ampere D.C. meter. The 6F5 is operated at reduced filament voltage to eliminate instability. Low loss construction is used throughout. The instrument was built up around a Miller T-550 coil kit that covers from 50 Kc. to 20 Mc. in five switching positions. While there is still a lot to be desired in this kit, it is low-priced and readily available.

The constructor should take care to see that no coupling other than that brought about by condenser  $C_3$  occurs between the oscillator and the cathode follower and V.T.V.M. stages. This may be checked by resonating a high "Q" coil, then disconnecting  $C_3$  from the oscillator and grounding the 6N7-G grids. If a reading is still obtained, better by-passing of circuits is in order, or better shielding between the oscillator and other stages. Since, due to the impracticability of specifying a standard set of parts, no layout will be given, these precautions may vary with individual instruments.

One component of a very special nature is the non-inductive resistor  $R_{11}$ . This was made from a one-half-inch piece of nichrome wire folded back on itself with a

very thin sheet of mica between wires, then covered with mica and clamped in a folded half-inch square piece of 20-gage sheet metal. The unit, which has a resistance of .0625 ohm, was then hard-wax impregnated.

The Comparator was built on a 10 x 17 x 3-inch chassis, with stages isolated by proper shielding and circuit insulation. As may be seen in the photograph, ordinary numbered dials were used, the author plotting curves against the dial readings. There are five curves for the oscillator and two for the investigation capacitor,  $C_1$ —one for a single section in the circuit and another for both sections connected in parallel. This connection is made by means of the binding posts on top of the cabinet, as may be seen in the schematic.

Dials should be of the vernier type and preferably of large size. Four inches should be the minimum for easy reading and a higher degree of accuracy and "resetability."

The constructor may calibrate this equipment to an accurate degree and thereby have a very reliable and useful instrument. With the investigation capacitor calibrated, measurements of R.F. inductance and capacitance may readily be made. Calibration of the oscillator makes the device a signal generator and frequency meter. For direct comparison tests, however, such calibration is not necessary.

## COMPARISON TESTS

R.F. coils under investigation are simply connected across terminals "LX" and resonated with  $C_1$  till the maximum deflection of the meter is obtained. The indication on the V.T.V.M. will then indicate whether the "Q" is above or below that of the coil used for a standard.

To check a capacity, a coil is first placed across the terminals LX and resonated by means of  $C_1$ . The condenser to be measured is placed across terminals  $C_X$  and condenser  $C_1$  again turned to resonance. If  $C_1$  is calibrated in capacity, the capacity of the unknown condenser is the difference between the capacities at the two settings. For comparison only, as in production tests, it is only necessary to turn  $C_1$  to a minimum or other convenient setting and resonate the coil with a standard condenser across the CX terminals. Other condensers resonating



The Comparator. Connection to components being tested are made by posts at upper right.

without retuning the circuit, or resonating within a certain fixed tolerance—within a certain number of degrees on the  $C_1$  dial—are then acceptable.

Sixty-cycle modulation is incorporated, and the instrument may be used as a signal generator by connecting a 100-mmf capacitor in series with the "LO" terminal of LX as the output lead, and the "LO" terminal of CX as the ground lead.

## PUSH BUTTON COMPARATOR

The second unit is composed of a triode in a Pierce oscillator coupled through a crystal filter unit to the same general circuits described above (6N7 cathode follower, etc.) This instrument uses twelve crystals,

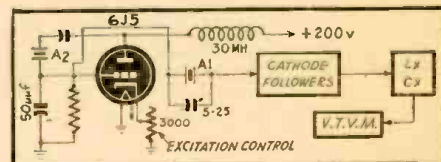

Fig. 2—Push-button Comparator. Six crystals are switched into each position shown.

six in the oscillator and six in the filter circuit. The Oscillator Crystal and the corresponding filter crystal is selected by push-button. The reader may wonder why the filter is necessary. It is to eliminate harmonic output or rather input to the cathode follower stage. It was also necessary to take excitation from the grid of the Pierce oscillator rather than the plate circuit. The capacitor used for excitation control in the oscillator is a rather good by-pass to ground for the harmonic energy. The frequencies used were 455 Kc., 600 Kc., 1000 Kc., 1500 Kc., 3 Mc., 6 Mc. The two low-frequency

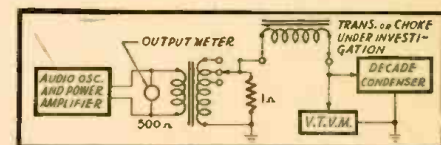

Fig. 3—A Comparator for audio frequencies.

crystals are of the "GT" cut type and the high frequency crystals the "AT" cut type. Filter Crystal  $A_1$  is approximately 15 mmf higher in frequency than the oscillator crystal  $A_2$ .

The main advantage of the crystal controlled Comparator is with large production runs of either transmitters or receivers. Usually a limited number of coils and condensers are under investigation and an accurate knowledge of frequency is necessary.

## AUDIO COMPARATOR

The third unit, illustrated in Fig. 3, is built around the typical "RC" type audio oscillator. The Hewlett-Packard type 200B with a power amplifier added may be used.

(Continued on page 499)

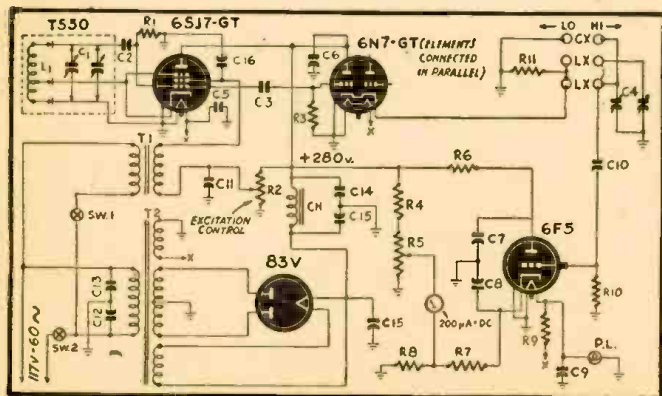

Fig. 1—Diagram of the Comparator shows few hard-to-get parts. Circuit is simple but extreme care in selection of materials and construction is required, to prevent leakage which would cause indications to become unreliable.



# PRACTICAL V.T.V.M.

By WM. B. MILLER

THE following is a description of a thoroughly practical vacuum tube voltmeter. The design is the result of much experimenting. A bridge circuit is used with feedback for stability.

In the original model a 6SN7 twin triode was used, which is the same as two 6J5's. Almost any triode with a separate cathode will serve. It was found that increased sensitivity resulted from the use of power tubes such as 6V6's and 6K6's connected as triodes. Two volts full scale, was all that was wanted, so a 6SN7 and a 500 microamp meter were used.

More sensitivity may be obtained from the circuit being described by substituting a 5000-ohm resistor in place of the 24,000 one from P.2 to ground. This reduces the

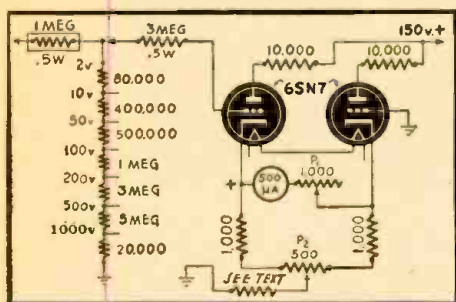

The balanced electronic voltmeter circuit.

feedback, however, and the meter loses some of its stability. Those lucky enough to possess a more sensitive meter, can use 6V6's in this circuit and get full scale deflection with a small fraction of a volt. There is one important thing to remember if other tubes are substituted, and that is they must be operated on the straight portion of their Eg- $I_p$  curves. If this precaution is not observed the meter deflections will not be linear.

The operation of the circuit is as follows: P.2, the 500 ohm potentiometer in the cathode circuit, is the balancing control. By varying this the cathode currents may be exactly balanced so that the meter pointer rests at zero.

When a voltage is applied to the grid of the active triode the balance is upset, because more current will then flow in the cathode circuit of this tube, creating a difference in potential between the two cathodes which, of course, is registered on the meter.

In constructing the meter almost any layout that fits an available chassis and cabinet will do. Where the meter is to be used near strong external fields which might influence it, a grounded metal cabinet should be used. The plate and cathode resistors should be fairly well matched so that the zero balance potentiometer will not lose its range of control.

Filtering of the plate voltage supply is of very minor importance. Any small choke or wire wound resistor will do in combination with a pair of 4 mfd. electrolytics. Regulation, however, is highly desirable. If a VR tube is not to be had though, a large bleeder current will help. Longer tube life will be realized if the heater voltage is reduced about ten percent; a 2-ohm, 5 watt

resistor in series will produce the required drop.

The only critical wiring is the input grid circuit; the 3 meg. resistor should be mounted right at the socket and as short a wire as possible used to connect to the arm of the switch. The test prod and lead should be shielded right up to the switch. Outside of these everything else is straightforward and the other leads may be cabled for neatness.

## CALIBRATING THE METER

Before attempting calibration the current through the VR tube must be set, if one is used. This is done by opening the wire from pin No. 2 on the VR socket to ground and inserting a milliammeter (50 Ma. range).

Remove the 6SN7 and turn on the power, then adjust the variable 5,000 ohm resistor until the current through the VR tube is well within its operating range, preferably about 20 Ma. Now the 6SN7 may be replaced and allowed to warm up. The voltage regulator tube will hold the plate voltage at 150 volts, plus or minus 1 volt, and will take care of normal line fluctuations.

The only way to calibrate a meter of any kind is to have some kind of a standard for comparison; either a known voltage or a meter of known accuracy. The first operation after the tubes have warmed for about twenty minutes and the meter has been exactly zeroed by means of P.2, is to adjust for the basic 2 volt range. Set the range switch to the first position and apply a small voltage, starting with about 1 volt. Gradually increase until a full 2 volts is applied. Watch the meter needle as the voltage is applied—increasing the resistance of P.1 if it tends to go off scale. With the 2 volts feeding in, vary P.1 until precisely full scale is registered on the meter. Now remove the external voltage and recheck the pointer for zero position. If it has shifted reset it and repeat the full scale adjustment.

When this operation is complete, the other ranges will depend for their accuracy on the precision of the multiplying resistors. Precision resistors are extremely hard to

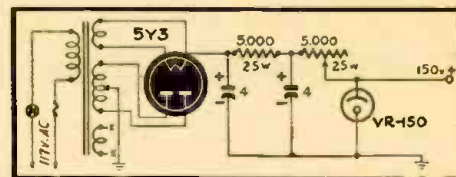

A voltage-regulated power pack is necessary.

obtain now, so part of each range section may be made variable for adjustment. If this is done adjust each range for full scale reading, starting with the 10 volt position and working up to the 1000 volt. Repeat the operation at least once as the total resistance from the prod to ground is just as important as the resistance between taps. Twenty percent of each range made adjustable will allow plenty of variation, if good carbon resistors are used.

When all the resistances have been set, a drop of Duco cement on the potentiometer shafts right at the bushings will hold them from unintentional shifting, P.2, being the Zero Adjustment, is on the front panel as it should be checked each time the meter is put into use. P.1, the 2-volt adjustment, is on the chassis and should be sealed after being set. It is only necessary to check each range at full scale as the meter is linear. If 1 or 2 watt resistors are used for the voltage divider they will have no noticeable variation with temperature and will only change because of aging. One watt resistors may also be used at all other points not otherwise marked on the schematic.

The writer is experimenting with a rectifier for the same meter to allow the reading of A.C. voltages and will pass the information along as soon as it is complete.

## CAPACITOR AND RESISTOR CODES

(Continued from page 494)

plays no part in indicating resistance or tolerance but is used to indicate the type of resistor unit. Under the RMA code, a black body is frequently used to indicate an uninsulated composition unit, while a tan, olive, or white body usually indicates a wire-wound unit. The AWS code specifies that an uninsulated unit have a black or white body unless the body is a part of the color coding. The body of an insulated unit may be any color other than black although a natural tan is preferred. When there is doubt as to whether a particular resistor is composition or wire-wound, it is well to remember that any resistor of 100 ohms or less is most likely wire-wound and that it is probably wound inductively.

Several variations of this method are in use. With all these, however, the interpretation of the code is practically the same: left end (dot facing, leads downward) or narrower end stripe, tolerance; body, first significant figure; right end, second significant figure; and the central dot or band, number of additional zeros needed to complete the indication.

EXAMPLE: A 5,600-ohm plus-or-minus 10% resistor would be marked in either of two ways:

(A) First band, green (5); second band, blue (6); third band, red (00); fourth band, silver (plus-or-minus 10%).

(B) Left end, silver (plus-or-minus 10%); body, green (5); right end, blue (6); central band or dot, red (00).

TABLE VI. COLOR CODE FOR SMALL FIXED RESISTORS.

Color	First band or body	Second band or right end	Third band or center dot	Fourth band or left end
Black	0	0	none	*
Brown	1	1	0	*
Red	2	2	00	*
Orange	3	3	000	*
Yellow	4	4	0.000	*
Green	5	5	00.000	*
Blue	6	6	000.000	*
Violet	7	7	0.000.000	*
Gray	8	8	00.000.000	*
White	9	9	000.000.000	*
Gold	*	*	divide by 10	5%
Silver	*	*	divide by 100	10%
(body)	*	*	*	20%

\*not used.

# LET THIS "AUTOMATIC TEACHER" show you exactly how to repair over 4800 RADIO MODELS without expensive test equipment!

## SAVE TIME-SAVE MONEY!

Ghirardi's RADIO TROUBLESHOOTER'S HANDBOOK is the ideal manual to show you exactly how to quickly repair radios at home in spare time—quickly and without a lot of previous experience or costly test equipment. It contains MORE THAN 4 POUNDS OF FACTUAL, time-saving, money-making repair data for repairing all models and makes of radios better, faster and more profitably than you may have thought possible!

### NOT A "STUDY" BOOK

RADIO TROUBLESHOOTER'S HANDBOOK can easily pay for itself the first time you use it. You don't have to study it. Simply look up the make, model, and trouble symptom of the Radio you want to repair and go to work. No lost time! Clear instructions tell exactly what the trouble is likely to be—EXACTLY how to fix it. Actually, this big 744-page manual-size HANDBOOK brings you factual, specific repair data for the common troubles that occur in practically every radio in use today—for over 4800 most popular models of Home and Auto-radio receivers and Automatic Record Changers of 202 manufacturers! In addition, there are hundreds of pages of helpful repair charts, tube charts, data on tuning alignment, transformer troubles, tube and parts substitution, etc., etc.—all for only \$5 (\$5.50 foreign) on an UNRESERVED 5-DAY MONEY-BACK GUARANTEE!



## Get a Complete RADIO-ELECTRONIC SERVICE EDUCATION AT HOME—WITHOUT AN INSTRUCTOR



### TEST INSTRUMENTS—TROUBLESHOOTING REPAIR

A. A. Ghirardi's big 1300-page MODERN RADIO SERVICING is the finest, most complete instruction book on Radio-Electronic service work for either the novice or the professional Radio-Electronic serviceman—*bar none!* Read from the beginning, it is a COMPLETE COURSE IN SERVICING by the most modern methods. Used for reference, it is an invaluable means of brushing up on any servicing problems that puzzle you.

Gives complete information on all essential service instrument types; how they work (with wiring diagrams), when and why to use them; how to build your own; preliminary trouble checks; circuit and parts analysis; parts repair, replacement, substitution; obscure radio troubles; aligning and neutralizing; interference reduction—and hundreds of other subjects including How to Start and Operate a Successful Radio-Electronic Service Business. 706 self-testing review questions help you check your progress EVERY STEP OF THE WAY. Only \$5 complete (\$5.50 foreign).

### 5-DAY MONEY-BACK GUARANTEE

Technical Division, MURRAY HILL BOOKS, Inc.  
Dept. RC-55, 232 Madison Ave., New York 16, N. Y.

- Enclosed find \$..... for books checked, or  send C.O.D. (in U.S.A. only) for this amount plus postage. If not fully satisfactory, I may return the books at the end of 5 days and receive my money back.
- MODERN RADIO SERVICING \$5 (\$5.50 foreign)       RADIO TROUBLESHOOTER'S HANDBOOK \$5 (\$5.50 foreign)
- Special MONEY-SAVING COMBINATION  
Both big books for only \$9.50 (\$10.50 foreign)

Name .....  
(Please print or write plainly)

Address .....

City and Dist. No. .... State .....

### MONEY-SAVING OFFER!

While the present limited supply lasts you can get BOTH big books—radio's most famous complete Modern Service library totaling over 2030 pages—at a bargain combination price. See coupon.

## IMPROVED TUBES NEEDED FOR INDUSTRY, CONTROL

Quality of electron tubes in many delicate control applications—especially in aircraft and tanks where vibration is a decisive factor—is much more important than in the home radio, where large tolerances from optimum characteristics are permitted. This point was brought out in a report by Lt. R. J. Colin, Jr., in a paper read at the annual meeting of the Society of Automotive Engineers held early this year.

"The critics of electronic controls for aircraft," he said, "question their reliability perhaps more than anything else. They feel that a vacuum tube is a very temperamental and mysterious device—at any rate a thing not to be depended upon. Fortunately we now have sufficient field experience—particularly in the European theater of war—to answer such criticism. Reports from this theater have demonstrated that such controls are practical and reliable. We must not forget that this test of these controls is under actual battle conditions. In the matter of altitude and low temperatures alone, electronic controls are getting many hours of flight tests which would have been impractical to obtain before the war began.

"It should be emphasized that the grade of vacuum tubes used in these controls are the ordinary commercial receiving tube types. When it is possible for tubes designed to be used in ordinary home radio receivers to make a reasonably good performance record, tubes of the highest possible quality would leave little to be desired.

"The possibility of making a vacuum tube as reliable as other apparatus components for a given life span is not something to be hoped for. It can be done and has been done. There are at least two producers in the United States of high quality tubes of this nature. The essential difference between high quality tubes and ordinary "garden varieties" is the care exercised in their construction, selection of materials, pumping and de-gassing thoroughness, mechanical tolerances, and general ruggedness. Therefore it can, I believe it can, be concluded that the electrical components (including tubes), going into an electronic control are actually the factors which would put a certain electronic control in either the first or second reliability classification."

The foregoing is important as pointing out that the present success of electronics is being achieved with equipment not yet thoroughly adapted to the work which must be done. In the Electronic Age, we will have tubes built especially for the job in which they are used—long-life filaments for tubes which must be "on" 24 hours per day, vibration-proof tubes for applications involving rough treatment, and many other variations, such as constant-frequency design features for certain types of intrusion alarms and wide-range temperature characteristics for gas rectifiers used in some kinds of equipment.

The electron tube, regarded by many as a finished product, may still be in its infancy!

### PALEY GERMAN RADIO HEAD

Control of entertainment in occupied Germany is to be in the hands of Col. William S. Paley, well-known in American radio and former head of CBS. It is understood that his duties, while primarily concerned with radio, will also extend over moving pictures and other forms of entertainment.

Col. Paley, who received his commission two months ago, was expected to start his new job at once.

**"BORROW" THESE BOOKS** for 5 full days. Money refunded if you don't like them!

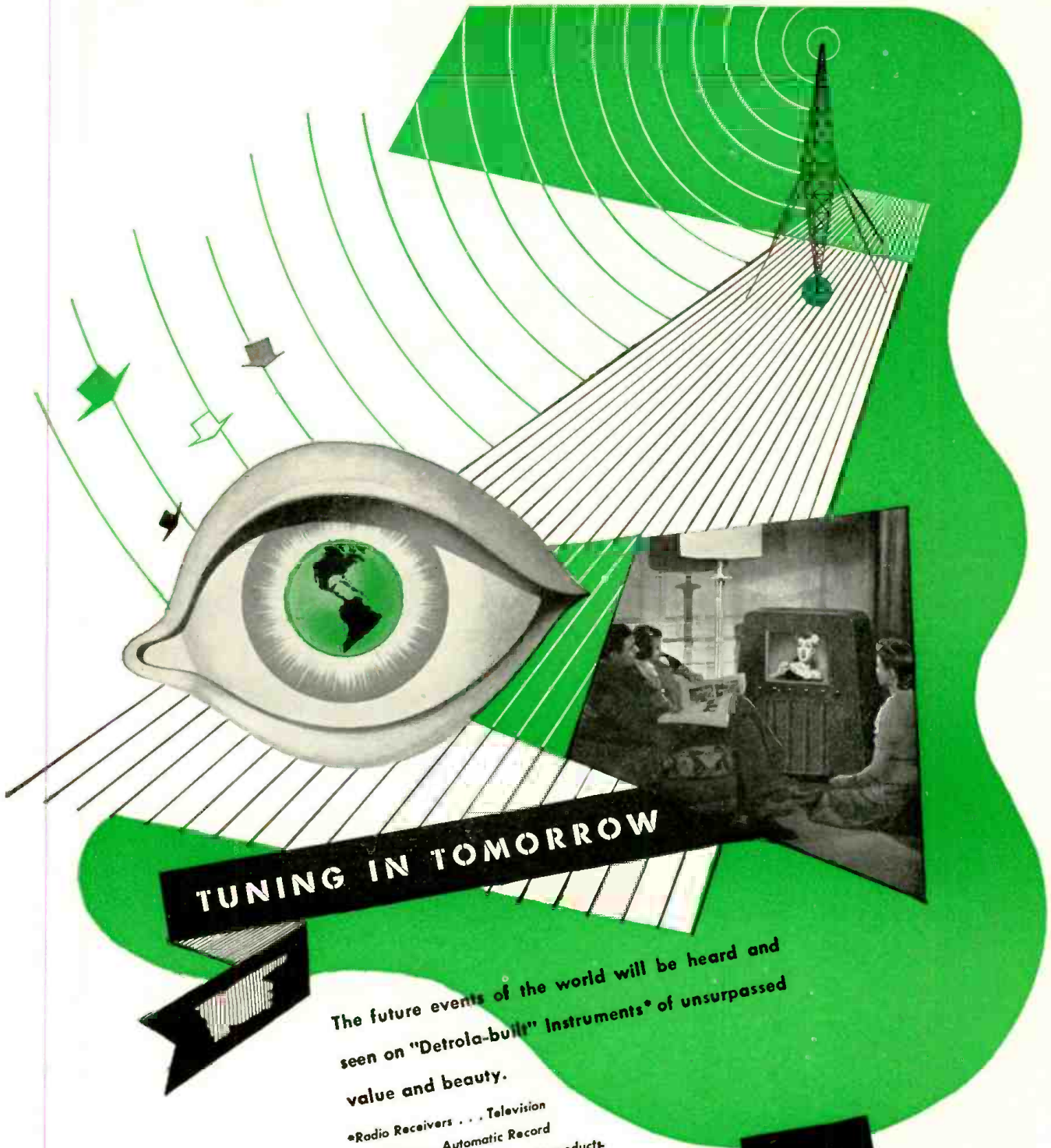

**TUNING IN TOMORROW**

The future events of the world will be heard and seen on "Detrola-built" Instruments\* of unsurpassed value and beauty.

\*Radio Receivers . . . Television Receivers . . . Automatic Record Changers, and other electronic products.

KEEP AN  ON  **Detrola radio**

division of  
**INTERNATIONAL DETROLA CORPORATION**  
Detroit 9, Michigan



More WACS needed  
for hospital technicians

# Remember?

## HOW THE N. U. EQUIPMENT PLAN HELPED SERVICE DEALERS PROSPER!

Here's a typical example of how service dealers obtained the test equipment they needed through National Union deals. This N. U. plan was OK'd 60,000 times by radio service dealers — and helped make servicing more profitable for thousands!

**SERVICE DEALER**  
"I SURE DO NEED A NEW TUBE TESTER BUT SIMPLY DON'T HAVE THE CASH TO BUY ONE"

**SERVICE DEALER**  
"GOT ANY IDEAS HOW I CAN GET A NEW TUBE TESTER?"

**PARTS JOBBER**  
"CERTAINLY, JOE, PICK ONE OUT OF THE N. U. EQUIPMENT ENCYCLOPEDIA AND I'LL TELL YOU HOW YOU CAN GET IT"

**SERVICE DEALER**  
"SWELL" "HERE'S THE ONE I WANT. NOW WHAT DO I DO?"

**PARTS JOBBER**  
"THAT'S EASY—JUST SIGN THIS AGREEMENT TO USE N. U. PRODUCTS AND LEAVE A DEPOSIT. THE TESTER WILL BE SHIPPED TO YOU AT ONCE"

**SERVICE DEALER**  
"OH"

**SERVICE DEALER**  
"DO I HAVE TO BUY A LOT OF N. U. PRODUCTS RIGHT AWAY AND WHEN DO I GET MY DEPOSIT BACK?"

**PARTS JOBBER**  
"NO SIR, BUY THE PRODUCTS AS YOU NEED THEM AND WHEN YOU'VE EARNED THE POINTS CALLED FOR ON THE CONTRACT YOU GET YOUR DEPOSIT BACK AS A MERCHANDISE CREDIT"

**SERVICE DEALER**  
"OK PAL IT'S A DEAL"

**AFTER THE WAR MORE THAN BEFORE**

**6**

# NATIONAL UNION

## RADIO AND ELECTRONIC TUBES

Transmitting, Cathode Ray, Receiving, Special Purpose Tubes • Condensers • Volume Controls • Photo Electric Cells • Panel Lamps • Flashlight Bulbs

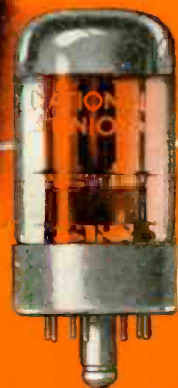

## WHAT PEOPLE WANT IN POSTWAR RADIO

AMERICAN families will buy 100,000,000 radios within the first five or six years after total victory, according to a survey just completed by Sylvania. Two-thirds of the current population will order the first new sets on the market—preferably combination radio-phonograph models. More people say they will pay an additional \$75 for television than will spend \$10 extra for FM. (Frequency Modulation), but if FM doesn't dig a hole in their pockets any deeper than \$5 they say they want it almost to a man; demand as many gadgets as they can get, insist on short wave although they seldom use it on their present sets.

The survey, which was conducted by one of the country's leading market research organizations, was notable in its coverage of the small city and town areas, which represent so important a part of America's buying public.

The 31,000,000 radio homes in the country now have an average of 1.54 sets per home and not only has there been a steady increase in the number of people owning a radio but an equal growth in the number of families owning two or more sets is indicated.

In the past, radio buyers displayed little loyalty to the brand of radio already owned. Illustrating this, sixty-three per cent of the families who own three sets admitted that all three were different brands.

While the average set is turned over every seven years, half the radios now in operation are between four and eleven years old and their owners have little to say against them. Only five per cent expressed any real dissatisfaction.

Frequency Modulation will be a big selling factor, with over ninety per cent of the people looking forward to it. A small group would be willing to pay \$30 extra for FM, half those interviewed would pay an additional \$10, but the majority of listeners would prefer to pay only about \$5 for the clearer reception possible with FM.

Provided that telecasting stations are within range, and program quality is acceptable, the public think they will buy fifteen million television sets at \$75 over the usual cost of a radio set. Survey results show that at present only a little over three per cent of the people will pay \$300 and under thirty per cent want to see television programs if it adds \$125 to \$200 to the cost of the set.

Home radio owners are divided almost equally among those who have short wave facilities and those who do not. Even those who have short wave and don't use it will want it on their new sets. At present only about 5% of U.S. radio families listen to short wave programs regularly.

Push button tuning is fairly popular. Of the 31% that have it, three-quarters like it, the rest report unsatisfactory service, which indicates, according to Sylvania, a need for considerable improvement.

Asked what they like about their sets, owners had this to say, in the order mentioned: Tone and reception is good on over 75% of the sets, half the owners are pleased with the models and styles, like the tuning, get good distant reception, get good volume, little static.

As soon as radios become available, over twenty million families will buy new ones. Over 46% say they want Radio-Phono models, the majority preferring console styles. The figures show a trend toward one basic model for each home and additional small sets in other rooms—kitchen, bedroom, playroom and the like.

*The Standard of Quality  
for a Third of a  
Century*

**HICKOK**  
INSTRUMENTS



Volt-Ohm-Milliammeter



All-Purpose Tube and Set Tester



Signal Generators

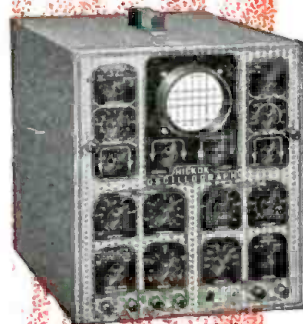

Oscillograph

## ELECTRONIC and RADIO SERVICE Equipment

HICKOK Instruments have long been known as the ultimate in scientific development. Illustrated here are but 4 of our 36 leaders in the Radio Service field. Thousands of Radio Service men have preferred HICKOK Instruments because of their unusual accuracy and dependability. • HICKOK pioneered in Dynamic Mutual Conductance Tube Testing Equipment. In the field of Signal Generators, Tracometers, Vacuum tube Voltmeters, Oscillographs, Zero Current Testers, Volt-ohm-milliam-meters and Industrial Analyzers the name HICKOK is assurance of excellence.

**THE HICKOK ELECTRICAL  
INSTRUMENT COMPANY**  
10531 Dupont Ave., Cleveland 8, Ohio

**NEW EDITION  
NOW READY**

# Audels RADIOMANS GUIDE

*Includes* **TELEVISION  
AND ELECTRONICS**

**LARGER - MORE COMPLETE - 914 PAGES - 633 ILLUS - WIRING DIAGRAMS - PHOTOS**

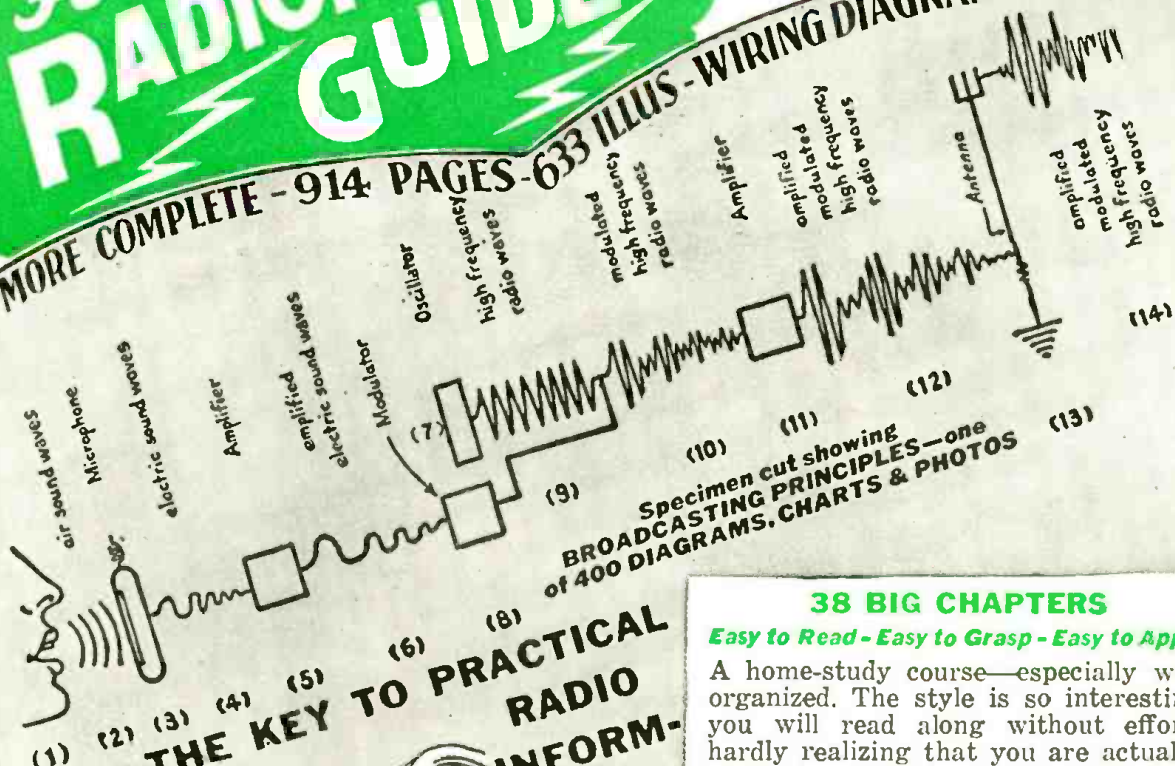

**THE KEY TO PRACTICAL RADIO INFORMATION**

It gives you in usable form pointers on radio, including frequency modulation, television, etc. Also valuable inside information for Aviators, Marines, Commercial Operators and Technicians, Servicemen and Students.



**Q AND A  
UNIQUE  
QUESTION  
and  
ANSWER  
METHOD**

*Highly Endorsed*

**38 BIG CHAPTERS**

*Easy to Read - Easy to Grasp - Easy to Apply*

A home-study course—especially well organized. The style is so interesting you will read along without effort, hardly realizing that you are actually studying and taking in vital information. Audels Radiomans Guide gives you just the right amount of mathematics required to cope with radio problems successfully. You can solve, with the aid of this extraordinary book, practically every radio problem that comes up. At your finger tips is a complete index for instant use.



**1001 RADIO FACTS AND FIGURES  
A Complete Library In One Book**

AUDELS RADIOMANS GUIDE gives authentic Principles and Practices in Construction, Operation, Service and Repairs. Covers clearly and concisely radio fundamentals—Ohm's Law—Physics of sound as related to radio science—Measuring instruments—Power supply—Resistors—Inductors—Condensers—Transformers and examples—Broadcasting stations—Radio Telephony—Receivers—Diagrams—Construction—Control Systems—Loudspeakers—Antennas—AutoRadio—Phonograph Pick-ups—Public Address Systems—Aircraft and Marine Radio—Radio Compass—Beacons—Automatic Radio Alarms—Short Wave—Coil Calculations—Testing—Cathode Ray Oscillographs—Static Eliminations—Trouble Pointers—Underwriter's standards—Units and tables. REVIEW QUESTIONS—READY Reference Index.

**7 DAYS' FREE TRIAL**

THEO. AUDEL & CO., Publishers  
49 West 23rd Street, New York 10, N. Y.

Mail AUDELS NEW RADIOMANS GUIDE for free examination. If O. K. I will send you \$1 in 7 days; then remit \$1 monthly until \$4 is paid. Otherwise I will return it.

Name \_\_\_\_\_ RCF  
Address \_\_\_\_\_  
Occupation \_\_\_\_\_  
Reference \_\_\_\_\_

**\$4 COMPLETE \$1 PAY ONLY 1 MO.**

**MAIL THIS COUPON TODAY**

## TEST COMPARATOR

(Continued from page 496)

The generator output is coupled to a linear standard (UTC) output transformer and connected to the typical circuits.

This unit has been of particular advantage in checking audio transformer tolerances and audio oscillation transformers for frequency range. It is also used to check filter chokes and will check all types of laminated iron core components. Numerous other uses will, of course, present themselves to the constructor.

### Parts List

- L1—Miller T-550 Coil Kit 50 Kc. to 20 Mc. 5 bands
- C1—365 mmf. 2 section low loss capacitor
- C2—100 mmf. silver mica capacitor
- C3—500 mmf. silver mica capacitor
- C4—Same as C1
- C5—.01 mfd. midget mica
- C6—Same as C5
- C7—Same as C5
- C8—Same as C5
- C9—Same as C5
- C10—Same as C5
- C11—.25 mfd. 600 V. oil paper
- C12—Same as C5
- C13—Same as C5
- C14—4. mfd. 600 V. oil filter capacitor
- C15—4. mfd. 600 V. oil filter capacitor
- C16—Same as C3
- V1—6N7G
- V2—6F5
- V3—83 V.
- V4—6SJ7GT
- PL—Mazda No. 46 6-8 V. .25A
- T1—Pri and Sec both 115 V. (Commonly used as AC-DC receiver isolation transformer)
- T2—Stancor P-6011
- R1—40,000 ohms 10-watt wire-wound
- R2—50,000 ohm pot. wire wound (Hi-current type)
- R3—10 megohms 2 watt
- R4—50,000 ohms 10 watt wire-wound
- R5—500 ohms pot. 3 watt
- R6—2000 ohms 2 watt
- R7—25,000 ohms 2 watt
- R8—15,000 ohms 2 watt
- R9—1. ohm 10 watt wire-wound
- R10—100 megohms (10-10 meg. 1/4-watt in series)
- R11—Special .0625 ohms non-inductive Meter—Weston 301. 0-200 Microampere D.C.
- CH—150 ohm 75 Ma. filter choke (Metal chassis and cabinet)

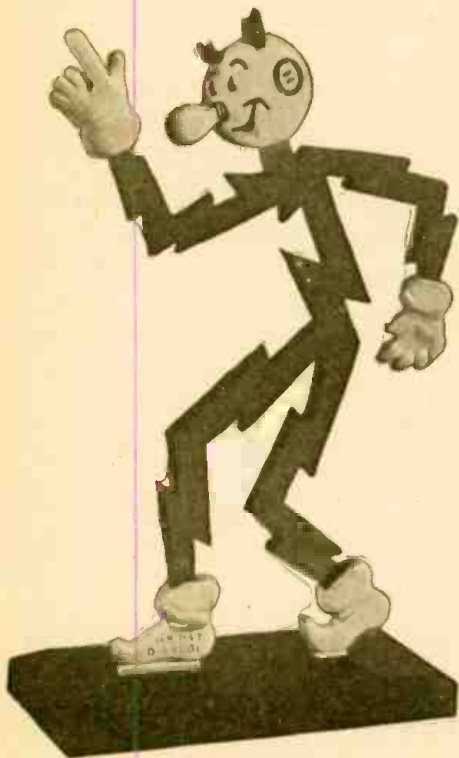

Courtesy Mack Molding Co.

Cousin to Alec Electron and the Erg twins, Reddy Kilowatt represents the idea of electricity for 200 power companies. Reddy is a bright red celluloid figure, five inches tall.

# ALL THE SCIENCE OF BASIC RADIO-ELECTRONICS

in one big  
3 1/2 lb. book

WRITTEN FOR BEGINNERS



36  
COURSES IN ONE

If this big book were broken into monthly lessons and sold as a "Course" you'd regard it as a bargain at \$50 or more! In this convenient book form you get it for only

\$5 COMPLETE

This is only a fraction of what RADIO PHYSICS COURSE brings you: First, over 300 pages devoted to a vitally important foundation in Basic Electricity . . . all made simple as A-B-C by clear explanations and over 150 illustrations; also broadcasting; Sound, Speech, Music; Radio transmission; Broadcasting stations; Receiving units; Vacuum tube theory, characteristics, construction, action; Detection; R-F amplification; Audio amplification; Superheterodyne receivers; Tuning coils; Loudspeakers! Microphones; Power Supply units; Auto Radios; Aircraft Radio; Phonograph pickups and amplifiers; Public address systems; short wave characteristics and equipment; Photoelectric cells; Television; Sound movies;—and many other subjects and chapters!

## "THE ELECTROLYTIC CAPACITOR"

An Important New Book on a Little-Known Subject

Probably no Radio-Electronic component is more vitally important than the Electrolytic Capacitor—and this new book by Alexander M. Georgiev, who has devoted more than 15 years to electrolytic capacitor research and development, answers all the many questions engineers, servicemen and others have been asking about the various types of electrolytic capacitors . . . their construction, characteristics, advantages, applications, measurement, testing, defects, etc., etc. Tells when and where to use electrolytics in preference to non-electrolytic types; relative merits of "wets" versus "drys"; applications at low and high voltages and frequencies; a-c or pulsating d-c, ambient conditions, etc., etc. The most important book ever written on this vital subject! Only \$3 complete.

## TRAIN NOW FOR THE BEST OF ALL POST-WAR JOBS!

A. A. Ghirardi's famous 972-page 3 1/2 lb. RADIO PHYSICS COURSE book with its 500 illustrations and 856 self-testing review questions can teach you basic Radio-Electronics from "scratch"—quicker, easier, and at far less cost than you may have thought possible! This ONE BIG BOOK (which is actually 36 Courses in One) has given more beginners their start in this fascinating field than any other book or course ever published! Also, it is used by more U. S. Army Signal Corps, Navy, and civilian schools and for more home study than any other book of its type on the market!

Nothing is omitted, nothing condensed. Everything is fully explained and made as easy as A-B-C. Ask any radio-electronic man! You'll be amazed how quickly RADIO PHYSICS COURSE will help you master subjects that other courses make seem very complicated. And you'll be even more amazed to find that it gives you a COMPLETE basic training—ALL YOU NEED easier, better, and faster—at a total cost of only \$5 complete. Send coupon today. Examine this truly great book for 5 days—we guarantee to refund every cent of your money if not more than satisfied!

JUST OUT



Complete modern data on Electrolytic Capacitors in one authentic volume.

## RADIO'S GREATEST TRAINING BUY!

Technical Division, MURRAY HILL BOOKS, INC.  
Dept. RC-55, 232 Madison Ave., New York 16, N. Y.

Enclosed find \$5 (\$5.50 foreign) for Ghirardi's RADIO PHYSICS COURSE book; or  send C.O.D. (in U.S.A. only) for this amount plus postage. If not fully satisfactory I may return it at the end of 5 days and have my money refunded.

Check here for Georgiev's "THE ELECTROLYTIC CAPACITOR" book. \$3 (\$3.50 foreign).

Name .....

Address .....

City and Dist. No. .... State .....

# 5-DAY MONEY-BACK GUARANTEE

# World-Wide Station List

Edited by ELMER R. FULLER

MR. FULLER is busy this month on a re-organization of the World-Wide Station List which he hopes will help to give a better service and quicker and more accurate reports. This has involved a great deal of work in typing up an index-card system which will speed up both incorporation of new reports and corrections to the

existing Station List. He has therefore been unable to spend time on the air, picking up the weaker and more elusive shortwave broadcasters. For this reason it has been impossible for him to prepare his usual monthly report on reception conditions and stations heard. The usual report will appear next month. All schedules are E.W.T.

Freq.	Station	Location and Schedule	Freq.	Station	Location and Schedule	Freq.	Station	Location and Schedule
11.040	CSW6	LISBON, PORTUGAL; Brazilian beam. 6:45 to 8:45 pm.	11.770	KCBF	LOS ANGELES, CALIFORNIA; South American beam. 5 to 8:30 pm; 8:45 to 11:45 pm.	11.880	LRR	ROSARIO, ARGENTINA; heard at 8:30 pm.
11.090	—	PONTA DEL GADA, AZORES; heard at 2:45 pm.	11.775	—	GENEVA, SWITZERLAND; 4 to 4:30 pm; 4:45 to 6 pm.	11.885	—	MOSCOW, U.S.S.R.; 6:45 to 7:25 pm.
11.115	MCH	LUXEMBOURG; heard with Army Hour for New York.	11.780	GVU	LONDON, ENGLAND.	11.890	KNBA	SAN FRANCISCO, CALIFORNIA; East Indies beam, 11 pm to 3:45 am.
11.145	WCBN	NEW YORK CITY; European beam. 1:30 to 4:15 pm.	11.780	—	PANAMA CITY, PANAMA; evenings; sometimes afternoons.	11.890	KNBX	SAN FRANCISCO, CALIFORNIA; South American beam, 7 to 9:30 pm; 9:45 to 11:05 pm.
11.405	—	DAKAR, FRENCH WEST AFRICA; 2:45 to 4:55 pm.	11.785	FZI	BRAZZAVILLE, FRENCH WEST AFRICA; about 3 pm.	11.893	WRCA	NEW YORK CITY; Brazilian beam, 6:45 to 7:15 am; European beam, 1:15 to 4:45 pm.
11.616	COK	HAVANA, CUBA; noon to midnight.	11.785	—	BELGIAN NATIONAL RADIO; heard at 6:30 to 7 pm; 9 to 9:15 pm.	11.897	JVU3	TOKYO, JAPAN; 8:15 to 8:15 pm.
11.645	—	BELGIAN NATIONAL RADIO; evenings about 8:30.	11.790	WRUW	BOSTON, MASSACHUSETTS; European beam, 1:30 to 8 pm.	11.900	XGOY	CHUNGKING, CHINA; Allied Forces in the Far East, 8 to 9 pm; Asia, Australia, New Zealand beam, 6 to 6:30 am; East Russia beam, 6:30 to 7 am; Japan beam, 7 to 7:30 am.
11.680	CMCY	HAVANA, CUBA; heard at 11 am.	11.790	WRUS	BOSTON, MASSACHUSETTS; North African beam, 6:30 am to 5 pm; 5:15 to 7:15 pm.	11.900	WGEX	SCHENECTADY, NEW YORK; European beam, 1:30 to 4 pm.
11.680	GRG	LONDON, ENGLAND; Near East, 1 to 4 am; Middle East, noon to 2:45 pm.	11.790	KGEX	SAN FRANCISCO, CALIFORNIA; East Indies beam, 5:15 to 6:45 pm.	11.900	CXA10	MONTEVIDEO, URUGUAY; heard at 8:15 pm.
11.690	XGRS	SHANGHAI, CHINA; 11:15 am to 12:30 pm.	11.800	—	MOSCOW, U.S.S.R.; heard at 7:25 pm.	11.930	GVX	LONDON, ENGLAND; North America, 1:15 to 3 am; 2:30 to 5:15 pm; Pacific, midnight to 4 am; India, 10:30 am to 12:30 pm.
11.695	—	BERLIN, GERMANY; North American beam, 7:15 to 9:45 am.	11.800	GWM	LONDON, ENGLAND.	11.940	—	MOSCOW, U.S.S.R.; 8:18 to 8:50 pm.
11.700	GVV	LONDON, ENGLAND; Africa, 11:30 am to 5 pm.	11.800	JZ1	TOKYO, JAPAN; heard at 1:45 pm.	11.950	—	MEXICO CITY, MEXICO; heard evenings.
11.700	PRL8	RIO DE JANEIRO, BRAZIL.	11.820	GSN	LONDON, ENGLAND; Pacific, 1:45 to 6 am.	11.955	GYV	LONDON, ENGLAND.
11.705	SBP	STOCKHOLM, SWEDEN.	11.826	WCRC	NEW YORK CITY; European beam, 7 to 11:15 am.	11.970	FZI	BRAZZAVILLE, FRENCH WEST AFRICA; noon to 8:50 pm; 1 to 2:30 am.
11.705	—	MONTEVIDEO, URUGUAY; heard at 8 pm.	11.830	WCRC	NEW YORK CITY; Brazilian beam, 11:45 am to 12:45 pm; European beam, 1 to 5:30 pm; South American beam, 6 pm to midnight.	11.995	—	LISBON, PORTUGAL; heard about 8:20 am.
11.705	CBFY	VERCHERES, CANADA; 11 am to noon.	11.840	VLC4	MELBOURNE, AUSTRALIA; 9:45 to 10:45 pm.	12.040	GRV	LONDON, ENGLAND; Australia, 1:45 to 6 am.
11.710	WLWS2	CINCINNATI, OHIO; South American beam, 6 to 8:15 pm; 8:30 to 10:30 pm.	11.840	—	SINGAPORE, STRAITS SETTLEMENTS; "Radio Shonan" heard at 7:30 am.	12.070	CSW	LISBON, PORTUGAL; heard 2:30 to 4 pm.
11.710	WLWK	CINCINNATI, OHIO; South American beam, 6:45 to 8:15 am; European beam, 8:30 am to 5:30 pm.	11.840	GWQ	LONDON, ENGLAND.	12.095	GRF	LONDON, ENGLAND; Near East, noon to 1:15 pm; Italy, 6 am to 1:15 pm.
11.710	VLG3	MELBOURNE, AUSTRALIA; 1:15 to 1:45 am.	11.847	WGEA	SCHENECTADY, NEW YORK; European beam, 6:30 am to 4:45 pm; Brazilian beam, 5 to 11:30 pm.	12.110	H13X	CIUDAD TRUJILLO, DOMINICAN REPUBLIC; noon to 5 pm.
11.718	CR7BH	MARQUIS, MOZAMBIQUE.	11.850	CE1185	SHANGHAI, CHINA; 9 to 10 am.	12.115	ZNR	ADEN, ARABIA; 11:15 am to 1:15 pm daily.
11.720	PRL8	RIO DE JANEIRO, BRAZIL; 9:35 to 10:45 pm; on Sundays.	11.855	—	SANTIAGO, CHILE; heard at 1:30 am.	12.120	DZE	BERLIN, GERMANY; African service, 11 am to 5:30 pm; Brazilian service, 5:50 pm to midnight.
11.720	CKRX	WINNIPEG, CANADA.	11.860	GSE	HAVANA, CUBA; evenings.	12.175	—	MOSCOW, U.S.S.R.; 11:10 to 11:20 am.
11.725	JVW3	TOKYO, JAPAN; heard at 2 pm.	11.870	WNBI	LONDON, ENGLAND; Africa, 11:15 am to 2:45 pm; South America, 4 to 10:15 pm; Mediterranean, 5 am to 3:45 pm.	12.190	LSN3	BUENOS AIRES, ARGENTINA; 7:15 pm.
11.730	WRUL	BOSTON, MASSACHUSETTS; European beam, 6:30 to 8 am; 10:30 am to 6 pm; Mexican beam, 8:30 to 9:15 am; 2 to 6:30 am; Caribbean beam, 6:18 to 7:15 pm.	11.870	WOOW	NEW YORK CITY; South American beam, 7:30 pm to midnight.	12.235	TFJ	REYKJAVIK, ICELAND; Saturdays, 10 to 10:30 pm.
11.730	—	LONDON, ENGLAND.	11.870	KW1X	NEW YORK CITY; European beam, 6:30 am to 3 pm.	12.265	—	MOSCOW, U.S.S.R.; 11:10 to 11:20 am.
11.740	COCY	HAVANA, CUBA; afternoons.	11.880	VLR3	SAN FRANCISCO, CALIFORNIA; New Guinea beam, 4:15 to 5:45 pm.	12.270	—	HAVANA, CUBA; evenings.
11.750	GSD	LONDON, ENGLAND; South America, 5:15 to 10:15 pm; Africa, 1 to 4 am; 5 to 11:15 am; 11:30 to 4:30 pm.			MELBOURNE, AUSTRALIA; 9:45 pm to 3:45 am.	12.445	HCJB	QUITO, ECUADOR; evenings.
11.760	—	BERLIN, GERMANY; evenings.				12.967	WLWR2	CINCINNATI, OHIO; European beam, 7 am to 5:30 pm.
11.765	—	ALGIERS; heard at 9:30 am and 1 pm.				13.000	HDD	QUITO, ECUADOR; 9:45 to 4:30 am.
11.770	DJD	BERLIN, GERMANY; North Amer-				13.022	WLWLI	CINCINNATI, OHIO; North African beam, 6:30 to 8:15 am; 9 to 9:45 am; 2:45 to 3:15 pm; 3:30 to 7 pm.

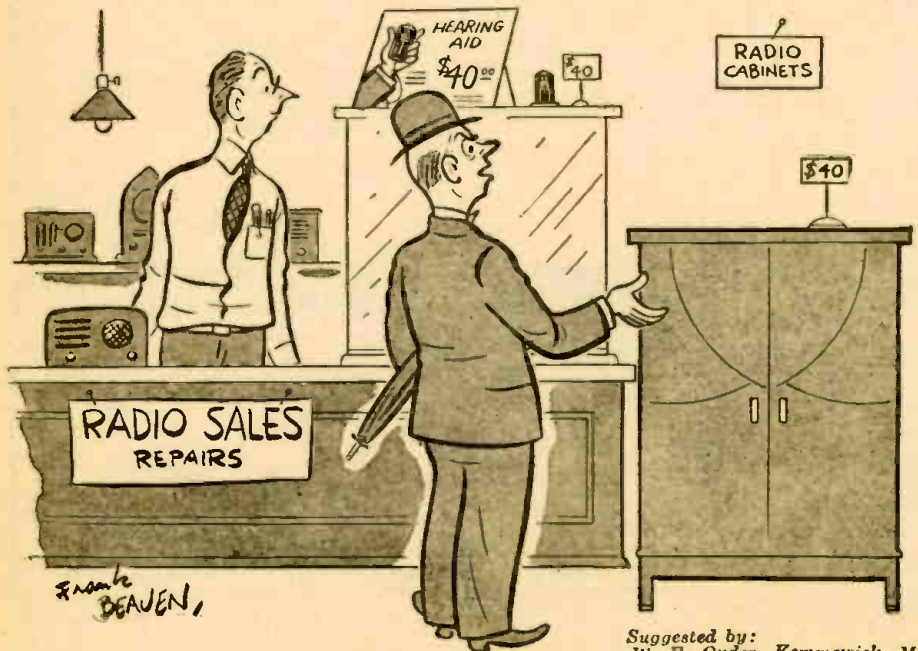

Suggested by: W. F. Onder, Kemmswick, Mo.

"If the price is the same, I'll take this one."

13.050	WNRI	NEW YORK CITY; European beam, 6:30 am to 3:30 pm.
13.050	KNBA	SAN FRANCISCO, CALIFORNIA; East Indies beam, 1 to 3:45 pm; 9:20 to 11:15 pm; Oriental beam, 4 to 6:45 pm; 7 to 9:05 pm.
14.540	—	PARIS, FRANCE; heard with Army Hour for New York.
14.560	WNRX	NEW YORK CITY; European beam, 6:30 am to 4:30 pm.
14.800	WQV	NEW YORK CITY.
14.950	—	PARIS, FRANCE; "Station Parée"; calls NBC and CBS with press reports.
15.000	WVW	WASHINGTON, D. C.; U. S. Bureau of Standards; frequency, time and musical pitch; broadcasts continuously day and night.
15.060	GWG	LONDON, ENGLAND.
15.070	GWC	LONDON, ENGLAND.
15.105	—	TOKYO, JAPAN; heard at 8:30 pm.
15.110	—	MOSCOW, U.S.S.R.; 9:15 pm and 11:15 pm; 5:15 to 5:40 pm.
15.110	DJL	BERLIN, GERMANY; African service, 11:10 am to 3 pm.
15.110	HCJB	QUITO, ECUADOR; 4:30 to 6:30 pm.
15.120	DKSA	"DEUTSCHER KURZWELLENSENDER ATLANTIK," location not disclosed; early evenings.
15.120	KRCA	SAN FRANCISCO, CALIFORNIA; Hawaiian beam, noon to 3 pm; 7 to 11 pm.
15.130	KGEX	SAN FRANCISCO, CALIFORNIA; South American beam, 11 am to 5 pm.
15.130	KGEI	SAN FRANCISCO, CALIFORNIA; South American beam, 5 to 8:30 pm.
15.130	WRUL	BOSTON, MASSACHUSETTS; Mexican beam, 9:30 to 10:15 am.
15.130	DXR7	BERLIN, GERMANY.

(Continued on page 527)



# Electrostatic Modulator

By R. S. HAVENHILL

At the June Meeting\* of the High Polymer Division of the American Physical Society at Rochester, New York, Messrs. R. S. Havenhill, H. C. O'Brien, and J. J. Rankin of the Research Laboratories of The St. Joseph Lead Company described a new electronic apparatus for measuring the electrical charges present on all substances such as air, water, dust, paper, cloth, rubber, synthetic rubber, etc.

The authors state that not only can these electrical charges, which they term contact potentials, be measured, seen on an oscillograph or heard in a loud-speaker,

amplifier and measured on an output meter. If a loud-speaker is used in the output circuit, the electrical charge on the specimen can be heard as a 300-cycle hum. If a cathode-ray Oscillograph is used the charge appears as a 300-cycle wave. The greater the charge, the greater the amplitude of the resulting wave. By the use of this apparatus in place of conventional electrometers, electroscopes and high-gain D.C. vacuum-tube amplifiers, instability and charge leakage in the grid circuit are eliminated. A special form of this device, in conjunction with a mirror surfaced metal plunger reference electrode system (See Fig. 1) for contacting the sample was used to measure the contact potential of various rubber and GR-S synthetic rubber compounds.

A photograph and line drawing of the Electrostatic Modulator are shown in Figs. 2 and 3. In measuring the charge, it is not necessary to contact the upper electrode plate on the modulator; in fact, the charge on a lucite rod can be detected at a distance of 15 feet from the apparatus. The minute charge brought about by touching a piece of rubber with the finger can also be measured.

The schematic diagram of the audio amplifier is shown in Fig. 4, along with parts values. It will be noted that the amplifier follows more or less standard P.A. System practice—is in fact an excellent P.A.-amplifier if the input is modified for mike or phone. A 6J7 completely shielded high-gain input stage feeds into a 6N7 dual triode which acts as a second audio and phase inverter. The grid circuit of the second audio is provided with a selector switch so that various values of grid resistance can be switched in. This takes care of a wide range of input voltages and still obtains nearly full scale deflection on the output meter for all ranges.

The output stage consists of two 6L6 beam-power tubes operating in push-pull. The output meter consists of a 1 Ma meter and 6H6 tube rectifier.

This amplifier was made to have a linear response so that the output meter readings would be proportional to the input voltages and electrostatic charges on the test specimens. The approximate gain of the amplifier is 110 DB and it has a power output of around 20 watts.

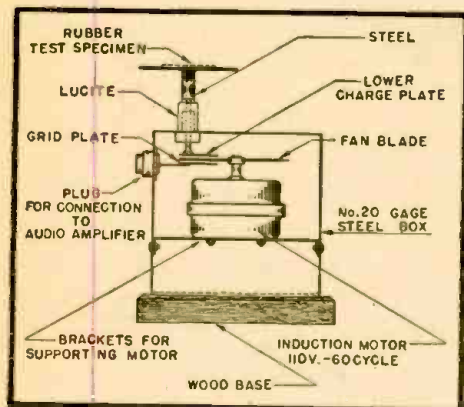

Fig. 3—Plan of the electrostatic modulator.

but they have found a correlation of them with the tensile strength on both natural and synthetic rubber compounds.

## DESCRIPTION OF APPARATUS

In this apparatus, which the authors call an "Electrostatic Modulator," the electrostatic lines of force established between the charged specimen and the grid of an audio frequency amplifier are cut or modulated at audio frequency by a motor driven fan blade. The resultant alternating current voltage is amplified and measured on a meter in the output circuit. In other words, the D.C. electrostatic charge on a charged body is converted into an alternating current voltage which is amplified by an A.C.

\* See Journal of Applied Physics, November, 1944, page 731.

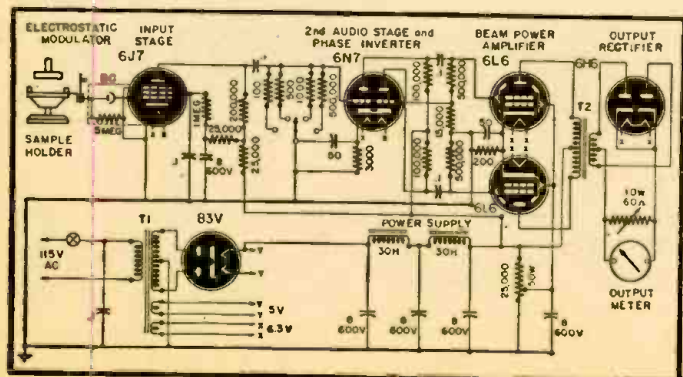

Fig. 4 — The special amplifier. Input circuit uses bias cell and must be completely shielded. Any good amplifier may be adapted for this work.

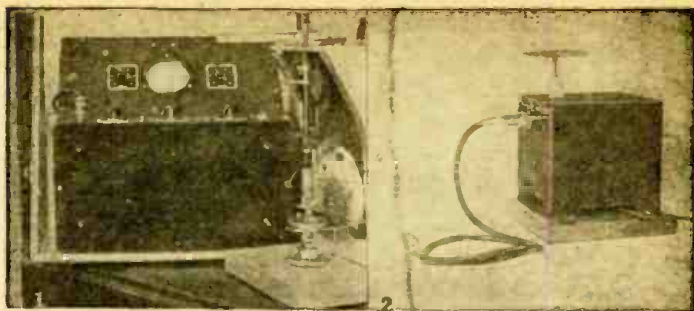

Fig. 1—The contact apparatus. Fig. 2—Electrostatic modulator.

In conclusion, the authors state that with the new apparatus, preliminary data indicate that both reinforcement and vulcanization of rubber are electrical in nature and support the formulation of an "Electrostatic Contact Potential Theory of Reinforcement."

## AUDIO AND THE EARS

AUDIO quality may reside in the ear of the listener to a far greater extent than has hitherto been suspected, according to F. Y. Gates, acoustical consultant at KSL, Salt Lake City.

A series of tests, made with a standard Western Electric audiometer on 44 members of the studio staff, revealed some startling facts. Of the 44 tested, only 23 were "normal," or possessed of average hearing in both ears. Six were sub-normal in both ears; six were sub-normal in one ear. Eight were abnormal (in the sense of having more acute hearing than average) in one ear; and one was abnormal in both ears. This was based on an acuity not in excess of 20 decibels from normal average.

These differences in hearing have a direct and marked effect in radio production. The person whose hearing was abnormal in both ears, for example, was a stenographer, noted for friendly but persistent "beefing" about the station's sound effects. They didn't sound "real" to her, she maintained. Her audiogram showed that her acuity was unusually high, making her a natural for a technician. Today she works in KSL's sound effects department, doing a bang-up job because she has much keener ears than the average person.

One of the station's producers frequently clashed with a control operator over the placement of microphones in regard to the violin section of the orchestra. Their audiograms showed that the producer was subnormal in hearing in higher frequencies, whereas the operator's hearing was abnormal in the higher frequencies. Thus, when the E string of the violin was barely audible to the producer, it was unbearably harsh to the operator. Shown their audiograms, the pair were able to adjust to their known strengths and weaknesses in hearing.

Another producer was shown to have decidedly subnormal hearing in certain frequencies. Knowing this helps him do better work—he now defers to an assistant in achieving microphone balance.

All in all, two members of the KSL staff were transferred to entirely new duties as a result of Mr. Gates' study, while five key men improved their work by learning to compensate for auditory irregularities. A slight, but very real, improvement in the quality of the station's output is the result of the series of tests, which was originally undertaken as pure research.

It may well be that certain radio "faults" can be traced to the listener rather than to the receiver!

# New Radio Electronic Devices

## LOUD-SPEAKER

University Laboratories, Inc.  
New York, N. Y.

THE AA-7 has a super-power audio capacity of 200 watts and is designed with 250 cycle low frequency cutoff for crisp clarity in voice projection. The projection range of this speaker is over 1½ miles.

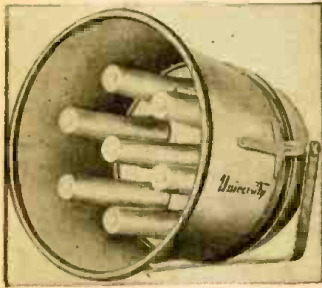

Projector is reflexed for compactibility and mounts a battery of 7 Model PAH hermetically sealed, shock and blast proof driver units. UNIVERSITY rubber damped rim construction effectively eliminates all trace of mechanical or acoustic resonance and rattle even at full power.

Construction is rugged, though relatively light-weight, with swivel mounting bracket for easy handling and rapid orientation. Projector may be subjected to continuous severe atmospheric exposure—waterproof protective coating and hermetic sealing assure unaffected performance. Perfectly adapted to marine or bulkhead mounting where rugged dependability is a prerequisite.

The AA-7 has many other applications for the commercial and sports field, besides its wartime use. Installations in stadiums, race-tracks, ball parks, shipyards, freight yards, airports, fire departments, etc., will find this AA-7 perfectly fitted to their needs.—Radio-Craft

## SNAP ACTION SWITCH

Grayhill  
Chicago, Illinois

THE phenolic body of the switch is round and measures only ¾-inch in diameter by 1¼" high, measured from the top of the push-button to the end of the solder lugs. The switch is mounted by a ¼-32 bushing, 7/16" long and held securely by two mounting nuts.

The fixed contacts are of fine silver overlay on phosphor bronze. These contacts are threaded and are held securely in place, the electrical connection being made by brass screws which also hold and secure the two solder lugs. The moving contact which bridges the two fixed contacts is also fine silver overlay on phosphor bronze,

which assures positive contact with the very minimum of contact resistance. The contact gap is .040-inch on each contact; therefore, the total contact gap which breaks the circuit is .080".

The Grayhill Snapit Switch employs a snap action principle which assures fast make and break as well as a contact pressure of approximately 35 grams, making the switch practical for use on D.C. current.

The Snapit Switch operates on a .0625-inch movement of the push button and carries a current rating of 10 amperes at 115 volts A.C., and 2 amperes at 115 volts D.C. It is general practice on D.C. current to increase the D.C. current rating with a decrease in the voltage.—Radio Craft

## MULTIMETER

Weston Electrical Inst. Corp.  
Newark, New Jersey

THE Model 695 Type 11, an extremely compact portable test instrument, is essentially a rectifier type voltmeter which

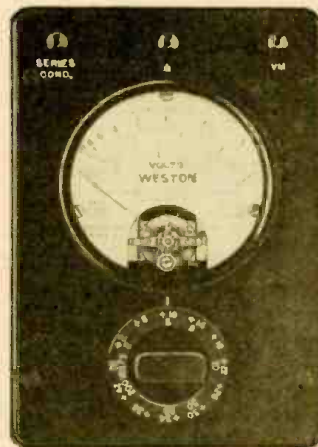

provides readings in decibels as well as in volts. Thus it is ideal for power level measurements in all types of sound equipment and in radio receivers—as well as A.C. voltage measurements from 2 to 200 volts full scale.

A medium speed instrument with moderately damped movement, Model 695 has a constant impedance of 20,000 ohms. When connected across any sound line, ranges can be shifted continually without varying line impedance. Eleven db ranges are provided, from -4 to +36 db at zero on the db scale. Seven a-c ranges from 2 to 200 volts also are available.

A self-contained condenser, available through a separate pin-jack is provided for blocking any D.C. component. The instrument is calibrated for 500-ohm lines with a zero level of 6 milliwatts or 1.732 volts. Each instrument is supplied with a chart

giving interpolation values on lines other than 500 ohms (from 5 to 10,000 ohms at 6 milliwatts zero level). Test leads supplied. Dimensions, 5½ inch x 3¾ inch x 3⅞ inch approximately.—Radio-Craft

## H-F CONDENSERS

General Electric Co.  
Schenectady, N. Y.

A LINE of high-frequency paper-dielectric capacitors, available in ratings of 5000 to 20,000 volts D.C., 0.01 microfarad, has been announced. De-

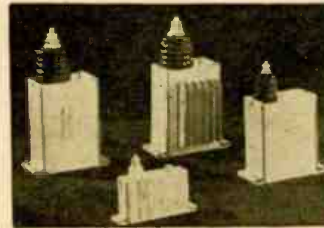

veloped primarily for grid- and plate-blocking service in the electronic-oscillator circuits of high-frequency induction-heating equipments, they can also be used to advantage in other high-frequency oscillator circuits of a similar nature.

The internal kraft-paper and aluminum-foil assemblies, compactly arranged and thoroughly impregnated with a low-loss liquid dielectric, are hermetically sealed in rectangular metallic cases. The size of the case cover and the over-all dimensions of the capacitor is reduced by use of a single insulated terminal, provided with a threaded terminal stud. For the other terminal, a stud is provided for connection to the case cover.

The units are supplied with removable footed-type brackets, which provide for a firm four-point mounting in any position. The 20,000-volt rating is available in two designs—one in a plain case, and the other with cooling fins to permit a higher current-carrying capacity.—Radio-Craft

## PRESSURE GAUGES

Precision Scientific Co.  
Chicago, Illinois

THE type "MR" instrument with a range of 0-500 microns utilizes the new Televac No. 500 Thermal Gauge with specially treated elements. Features of latter include coated filaments to prevent "off calibration" periods due to water, oil vapor or other contaminating vapors, increased sensitivity gained through use of two filaments in both standard and variable tubes of the vacuum gauge, all gauges are interchangeable without recalibration, and the user is assured of duplicate readings in

terms of absolute pressure in microns. The gauge is supplied with a special Leeds and Northrup Micromax Strip Chart Recorder calibrated directly in microns.

The type "S" recorder for ultra vacuum contains two ranges



—0-500 microns for pressures above 1 micron, and utilizing the No. 500 thermal gauge in this range and an industrial type ionization gauge for the range 0 to 0.4 microns. Accurate readings may be obtained down to 10<sup>-6</sup> mm Hg. (.001 micron). The type "S" instrument also features a safety circuit which makes it impossible to turn on the ionization gauge until a vacuum of 1 micron has been reached. Average life of ionization gauge is 3000 hours.—Radio Craft

## TRANSFORMER

Electronic Components Co.  
Los Angeles, Calif.

A NEW development in transformers with self-aligning, detachable mounting studs allows an actual tolerance in mounting dimension that can exceed one-quarter inch and eliminates rejects due to bad threads, leaks around studs, bent or broken studs or changes in length specifications.

A simple clip arrangement, stamped from heavy gauge steel, cadmium plated, prevents the stud from turning while it permits centering in two directions. The stud can be moved (not bent) in four directions to align with irregularly spaced holes and is replaceable in the field with any round head machine screw available.—Radio Craft

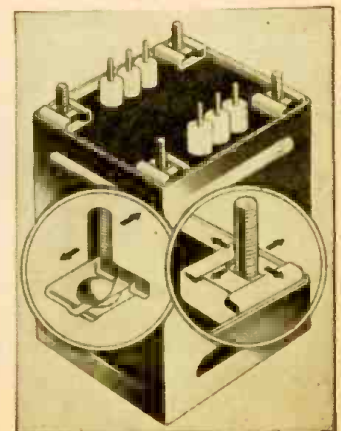

## RADAR POSSIBILITIES

(Continued from page 477)

to the C.A.A. for this research.

At airports the radar tower control will permit the tower operators to see on a screen the actual position of any and all aircraft within a radius of about 25 miles. This immediately detects any hazardous condition that might occur because of a pilot's error or a mechanical failure in the radio landing system. The radar operator can then adjust the controls of all out-bound traffic at a fog bound airfield, because he will have complete knowledge of the exact position of all planes. The only way in which this can be done today is for a ground operator to determine the position of planes near his field by position reports radioed in by pilots. Now only one such report can be handled at a time and the distance estimates are not always accurate.

The collision warning device is mounted right on the instrument panel of the plane. Here the radar screen will be of immense value. It will report to the pilot his own position in the air relative to other planes as well as obstacles in his path, such as radio towers, beacons, water towers, and other objects that may be hidden from actual eyesight.

With the collision radar instruments, pilots will find it easy to maintain proper distances from other aircraft while climbing to their assigned altitudes, or descending to an airport for landing. The complete landing approach will be handled by the pilot while the control tower acts as a monitoring agent through its radar screen. This will speed up landing and take-offs in thick weather.

## RAPID CONVERSION

(Continued from page 492)

Much has been said about the recent battery and portable radios using the 1.4-volt tubes. A word of caution on these sets. We have used 10-watt filament dropping resistors and had trouble. We now use 20-watt resistors. The trouble was that the filaments would drop to about 1 volt after a few days' operation.

Another method of hooking 1.4-volt tubes on bigger sets or portables is to use a 117L7/117M7 or a 117P7 and use a 450-ohm filter choke in the filter section. Wire the tube filaments in order, from cathode of the beam-power pentode section to ground through a 100-mfd., 25-volt condenser. Connect the tubes up in the order shown in Fig. 2. A system usable with a 25Z5 or 25Z6, 35Z5, 45Z3 or similar tube is shown in Fig. 3, which also shows the important bias arrangement. If tubes are not biased correctly the set will not work or will be inoperative. We use AVC on the 1A7, but the I.F. grid return goes to the negative or positive filament of the tube, whichever gives the most volume. The 1N5 may be very critical. We found sets getting locals only. Changing the grid return to its plus or minus filament prong—either direct or through a 500,000-ohm resistor by-passed to ground—would bring the sets to normal operation.

This outline cannot go into detail on the many modifications necessary or desirable for the various types of radios brought in for conversion, but it is hoped that it may act as a guide to profitable set conversions, that will make both the serviceman and the owner happy.

## Convenient Pocket-Size

for

## CONTINUITY TESTING

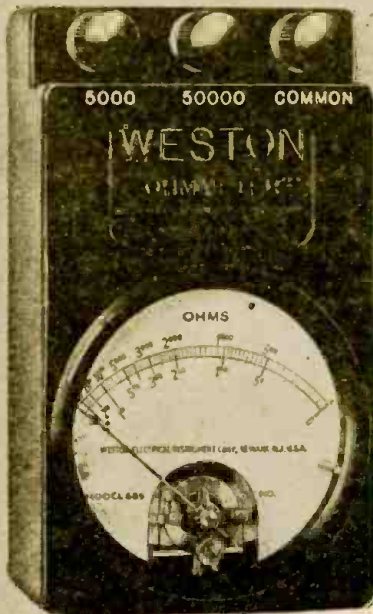

## WESTON MODEL 689 OHMMETER

Pocket-size but with typical WESTON dependability and ruggedness, Model 689 Ohmmeters are unequalled for checking circuits by resistance and continuity method. Available in two types . . . type 1E with double range of 0-5,000 ohms and 0-50,000 ohms, and type 1F with double range of 0-10 and 0-1000 ohms . . . ideal for motor maintenance. Entirely self-contained. Order through your local Weston representative, or direct from . . . Weston Electrical Instrument Corporation, 618 Frelinghuysen Ave., Newark 5, N. J.

**WESTON** Instruments

**LEARN RADIO-ELECTRONICS**  
TELEVISION, SOUND SYSTEMS, ETC.

**"Learn by Doing"**  
12-WEEKS Training  
IN COYNE SHOPS

Train now for a good job and a peace-time future in Radio-Electronics. Free employment service after graduation. Earn while you learn. If short of money, I'll finance your training.

We have facilities for men with physical disabilities. If you have a physical disability of any kind check here  and mail with coupon.

**Send coupon today for all details.**

H. C. Lewis, Pres., Radio-Electronics Div., Coyne Electrical School, Dept. 55-RH, 500 S. Paulina St., Chicago 12, Ill.  
Send Free Book and details of "Pay-After-Graduation" Plan.

NAME \_\_\_\_\_  
ADDRESS \_\_\_\_\_  
CITY \_\_\_\_\_ STATE \_\_\_\_\_

## BUILD YOUR OWN!

### \*FAST-FREEZER\*

It's Easy and Fun

Every amateur will be proud to build this modern household necessity. It just takes a few hours of your spare time to build, and operates electrically on any voltage. There's fun in building and profit in using this handy freezer. Saves up to 75%.



**NO EXPERT KNOWLEDGE NEEDED**

Our plans are simple and easy to follow and this 8 or 12 cubic foot size can be built of new or used parts. Mail \$1 bill, check or money order for complete plans and catalog.

**LEJAY MFG., 456 LeJay Bldg., Minneapolis 8, Minn.**

**BUY WAR BONDS**

# Radio-Electronic Circuits

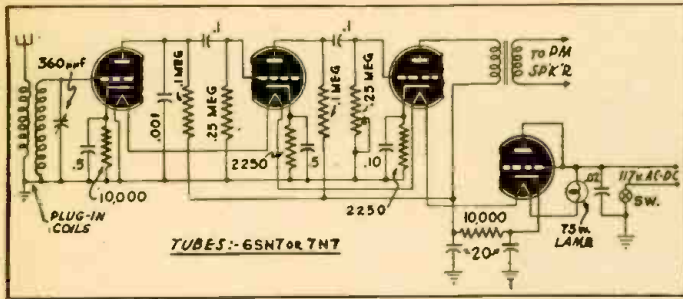

Figure 1

## MALODYNE RADIO

Figure 1

With tubes and parts so scarce, maximum use must be made of each. Being unable to purchase tubes for my portable, I decided to make a very small set with maximum output. Two dual triodes give me a four-tube set result.

Plug-in coils are used, the tuning condenser being 360 MMF. I am driving a 5-inch speaker with too much volume. The set includes a stage of R.F., detector, A.F. and half-wave power rectifier. If anyone can improve on it, I would like to know.

ALBERT MALINICK,  
San Diego, Calif.

## SIGNAL TRACER

Figure 2

This circuit has been in use for the past five years and has given an excellent account of itself.

The 6Q7 is used as the prod, being completely shielded but for an A.F. and an R.F. binding post. The tube is connected to the A.F. amplifier (last two tubes) by about 3 feet of 3-wire cable which includes the filament and plate voltage leads. Either a meter (plug-in) or the speaker may be used at the output.

PVT. J. LEONARD KING,  
Oceanside, Calif.

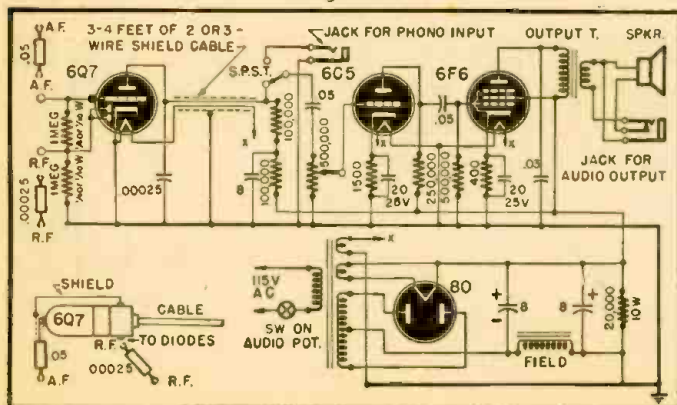

Figure 2

## "EXPRESSOR"

Figure 3

I have searched for some time for a simple volume expander-compressor which would be effective and not use a 6L7 which tends to be noisy and requires a lot of parts. I wanted to use the compressor for making transcriptions, the expander being more or less incidental.

Either a 6P7G or 6F7 may be

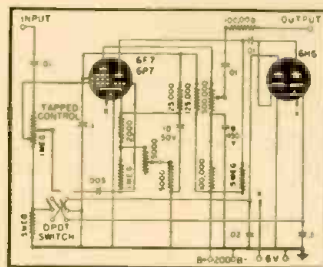

Figure 3

used, the triode section being used to obtain signal voltage for rectification. The .005 condenser blocks the input signal from the D.C. bias. A small value is best here, to prevent distortion.

When the DPDT switch is thrown upwards, the signal is expanded; downwards, it is compressed. Filter values are such that the compressor takes hold almost immediately and releases gradually, while the expander acts more slowly. The output control acts as master gain.

The 5000-ohm cathode circuit control is required for proper operation of the pentode. A low

value is good for compression and vice-versa for expansion. The screen voltage has been found very critical and no changes whatsoever should be contemplated in these circuits or in the audio filter components. The 100,000-ohm series resistor in the output can be changed to alter frequency response, but was found best in my case.

The input should not be too high for good fidelity. Output from a record player or the second detector of a receiver is about right. It is possible to obtain 30 to 40 DB change, and that is plenty deviation from normal.

DON LANGBELL,  
Edmonton, Canada.

## SPACE-CHARGE SET

Figure 4

Good volume on all local stations is had from this receiver which fits in a box 4 x 5 x 2. Note that the input is fed to the screen grid, and that the control grid is used as a space-charge element.

Two regular flashlight cells form the "A" battery, and 3 penlight cells are used for the "B". The grid coil has 95 turns 1 1/2" diameter, the tickler 35 turns wound just above. I use a 365 Mmf. trimmer (mica) with one plate removed.

JIM BROPHY,  
Chicago, 35, Ill.

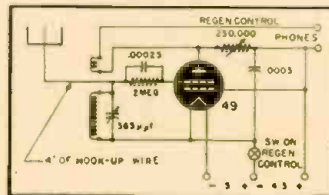

Figure 4

(The space-charge principle, in which the grid nearest the cathode is kept at a positive voltage to increase space current, was one of the oldest effects used in screen-grid tubes, but has dropped into obscurity. It is well worth some experimentation.—Editor)

## AUDIO OSCILLATOR

Figure 5

This compact oscillator may be used for A.F. generator purposes. It fits into a 4 x 4 x 6-inch cabinet. No danger of grounds or shocks exists, and very little heat is generated as compared to A.C.-D.C. sets. A voltage-doubling circuit supplies about 20 volts to the oscillator tube. This is ample for lone use.

A small grid condenser helps give a pure note. Different tones are provided for by the use of several values of condensers in a switching arrangement. Note that only low voltage filter condensers are required by the 6H6 doubling circuit.

DORIS G. VINEY,  
Glace Bay, Nova Scotia.

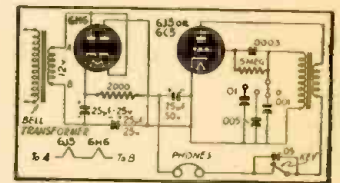

Figure 5

## 35-WATT AMPLIFIER

Figure 6

This extremely compact and high-powered amplifier is suitable for dancing, skating rinks and auditorium use. It has an excellent frequency characteristic to well over 8000 cycles. Low-note response is also excellent.

The output consists of two 6L6 tubes in class AB<sub>2</sub> for added volume and the phase inverter uses two 6C8 tubes. Elements of each are paralleled for added output. For home use input No. 2 is used, input No. 1 for an auditorium. No transformers are required for high impedance inputs. An ordinary push-pull output transformer may be substituted for the one shown.

GEO. CAMERON TREMBLAY,  
Chapleau, Canada.

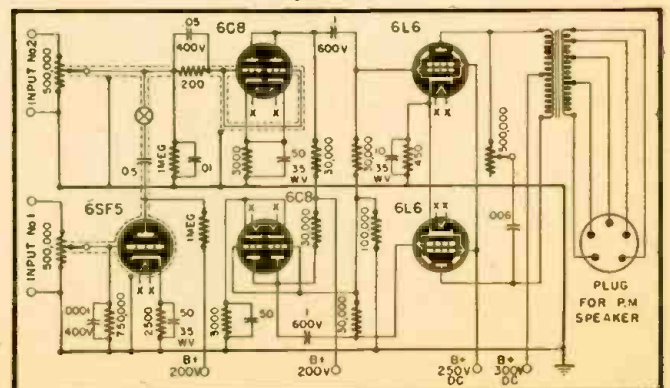

Figure 6

## FUTURE ASPECTS OF TELEVISION

(Continued from page 485)

actors are on the payroll continually—expense tripled, quadrupled. All this spells, if not bankruptcy at least discouragingly diminutive profits for the tele-producer, and this multiplied by the hundreds of television transmitters in operation throughout the nation.

The solution to this problem is simple. It is "Transcription," that savior of so many radio broadcasters. Here our transcription is on picture film, 16 and 35 millimeter. The contented audience didn't know it. They may have assumed that the actors they beheld were at that very instant performing before the iconoscope in the KWAD television studio. (Just as at last night's movie theater they all supposed those beautifully gowned stars and satellites were actually on the stage behind the picture screen!) But they had enjoyed that movie immensely, notwithstanding, and will go to another tomorrow night.

The bogymen "Immediacy" is simply silly. We have long ago learned that screen entertainment can be every whit as good as a stage performance—that a good screen play with top actors is miles ahead of one poorly presented by mediocre players on the theatre stage. And in television there cannot be a stage substitute. The show *must* be on a screen. The argument for Immediacy is therefore 100% eyewash. Misquoting Shakespeare: "The Film's the thing, to show before the public or the king." The film will prove the salvation of television. It will enable it to pay its producers. It will avoid long, letter perfect, rehearsals. All the refinements, the script-perusals, the cuts, the re-shots, the desired sequences, the instant flash to distant locales, the ingenious ways for best telling of a story which the movie industry has been learning through 40 years, is now at television's disposal. It is inconceivable that Television will fail to take full advantage of this knowledge, this art, this film.

Then vanishes, together with a whole mare's nest of small crowded studio technique, lighting, and camera difficulties—the greatest bug-a-boo of them all—the yet non-existent, still unsolved television chain broadcasting—whether by airplane-messed-up aerial links, or by continental coaxials, burdensomely heavy financially.

The solution is ridiculously simple—the nation-wide television hook-up is by the tin-can carrier, and express.

Scoff as you will may. Mr. Executive. Time, and Old Man Profit-and-Loss will soon show who is right!

Television with full natural color within two years after the end of World War II was offered as a possibility by Clyde M. Hunt, chief engineer of WTOP, in a talk last month.

"One or two years will be required for engineers to prove by field tests the results of their laboratory work," the veteran radio engineer declared, "and for the television industry to convert manpower and materials from war work to the peace-time pleasure of turning out your television receiver."

Television transmissions in full color were pioneered by the Columbia Broadcasting System in 1940, he said, and only the advent of the war, which threw the nation's radio research and manufacturing facilities into military channels, has delayed its normal expansion.



# It's FREE! It's NEW!

# CONCORD

## BUYING-GUIDE and REVISED LISTINGS

# Radio Parts

RADIO PARTS  
ELECTRONIC  
EQUIPMENT

HUNDREDS  
OF PARTS LIKE THESE  
—Many Available  
Without Priority

Just published! Concord's great, new 68-page Buying-Guide and latest 1945 Revised Listings of standard lines of Condensers, Transformers, Resistors, Tubes, Test Equipment, Repair and Replacement Parts, Tools, and hundreds of other essential items. Page after page of top-quality radio and electronic parts, and a special 16-page Bargain Section offering hundreds of hard-to-get parts at important savings. Mail the coupon now for your FREE copy. Use it to get what you need—and get it fast—from Concord.

Quick Shipment from CONCORD  
CHICAGO or ATLANTA

Concord carries vast stocks. Concord ships to you *at once* from the nearest shipping warehouse, CHICAGO or ATLANTA. Concord invites you to consult our technical experts on special requirements. Concord can expedite any "essential" order and speed action. Concord now serves the United States Government, Institutions, Industry—and can serve YOU, whether you want one part or a hundred. Telephone, wire, or write your needs. And rush this coupon for the new 68-page Buying-Guide. It's FREE.



### AUTO-LITE RELAY

Solenoid relay similar to relays on autos with push-button starters. 8.5 to 14 volts D.C., with heavy double make contacts. 3 3/4" x 3 3/4" x 2 1/4". A14516. Specially priced, **\$1.19**



### MIDGET POWER TRANSFORMER

Pri. 117 volts, 60 cycles. Secondary 6.3 volts @ .5 amps., 150 volts @ 150 M. A., 50 volts @ 65 M. A. Size 3 1/4" x 3" x 2 1/2". A5959. Your cost, **98c**



### 6" PM SPEAKER

Ideal for AC-DC radios, P. A., and Intercom re-placements. 5 8 7 0 0 0. Your cost, **\$1.98**



### TAPPED RESISTOR

Vitreous resistor, 90 watts, 6.4 ohms resistance tapped in 20 steps of .32 ohms ea. 58197. Your cost, each, **89c**



### HOOK-UP WIRE

# 20 solid rubber covered. Red or yellow. 100-ft. coils. Specify color. Your cost, each . . . . . **49c**



### KURMAN RELAY

Type 223C34. S.P.D.T. con-tacts. 2.5v. D.C., 8 MA, 300 ohm coll. 584020. Specially priced . . . . . **\$2.50**



### AUDIO REACTOR

Sealed. .15 Hy of O. D.C. current. Con 2" x 2" x 2 1/2" with 4 3/8 mfg. inserts. 5 8 5 0 1 0. Your cost, **\$2.95**

# CONCORD RADIO CORP.

## Lafayette Radio Corporation

CHICAGO 7, ILL.  
901 W. Jackson Blvd.

ATLANTA 3, GA.  
265 Peachtree Street

### Mail Coupon Today for FREE BOOK!

Concord Radio Corp.  
901 W. Jackson Blvd., Dept. RC-55  
Chicago 7, Illinois  
Please RUSH FREE copy of  
CONCORD'S new 68-page  
Buying-Guide and Revised  
Listings, just off the press.



Name . . . . .  
Address . . . . .  
City . . . . . State . . . . .



## IT WON'T BE LONG, NOW...

● Soon, yes and probably sooner, you'll see those "New Item" Aerovox cartons back on your jobber's shelves. There'll be many new items, new developments, new refinements in Aerovox capacitors because of war-time experience. And of course there'll be the good old standbys again—types Uncle Sam rounded up for the urgent needs of our fighting men.

Yes, it won't be long now. The moment Uncle Sam releases the gigantic Aerovox production facilities, you can begin counting once more on just the types you need in place of war-time "Victory" substitutes.

● Consult Our Jobber . . .

Meanwhile, consult our local jobber about your immediate and future requirements. Ask for latest catalog—or write us direct:

**AEROVOX**  
Capacitors  
INDIVIDUALLY TESTED

AEROVOX CORP., NEW BEDFORD, MASS., U. S. A.  
In Canada: AEROVOX CANADA LTD., HAMILTON, ONT.  
Export: 13 E. 40 ST., NEW YORK 16, N. Y. Cable: 'ARLAB'

# H. F. HEATING AT A GLANCE

Millions of dollars invested in H-F Heating give ample testimony for the future of the art. Industry and the home offer expanding postwar markets for the apparatus.

By WILLIAM LYON

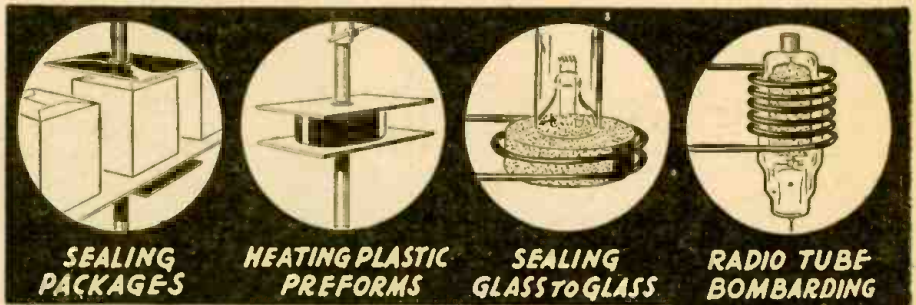

THE art of Radiothermics is divided into two branches:—  
*Induction and Capacitative Heating.*

Induction Heating works at a much lower frequency than that usually employed in a capacitative rig:— a wide range usually between 20 and 500 kc. It has reached a point of successful application during years of development the metal industries. Highly skilled labor isn't required to operate the equipment. Workers can be quite readily trained.

In the accompanying illustrations stippled areas within the field of the coils show the sections being heat-treated.

*Hardening metals* is accomplished with speed and uniformity. *Gears* and modern cylinder walls are two of the most glowing examples. *Annealing and normalizing* is accomplished in a fraction of the previously required time. All such applications as well as *brazing and soldering* have been put on the production line. They pass through the magic coil and, presto, the job is done! And *melting metal* is almost as simple as flowing water.

*Bombarding radio tubes* is one of the oldest Induction Heating accomplishments. Intricate *glass products* reached the production line through the same process. Imagine an internally water-cooled radio tube being turned out by the older methods! The cost would be prohibitive.

Fairly small portable rigs are used for *metallurgical analysis* and laboratory experiments.

Capacitative Heating is also called Dielectric Heating because, unlike Induction Heating, its application is to non-conductive material. The frequency range is higher and greater than that employed in Induction Heating.

The subject to be heated is placed between the two plates of a condenser. This is admirably illustrated in the accompanying sketch *heating plastic preforms*. While on the subject of plastics it is worthy of note that High Frequency Heating will "iron the bugs out" of future Bakelite radio cabinets. These housings have always been held to a wall thickness of one-eighth of an inch because of curing difficulties. Strengthening ribs are rarely over one quarter of an inch thick and at these particular points you will invariably discover distortion in the walls.

Future plastic cabinets will have walls one quarter of an inch thick with ribs and bosses from fifty percent to double this thickness. Capacitative Heating will be responsible for the uniformity and strength.

Almost any amount of heat at very high frequency can be applied when necessary for high speed of production, or necessary long, or short, curing time.

The illustrations showing *package sealing* and the *dehydrating of chemicals* will be (Continued on following page)

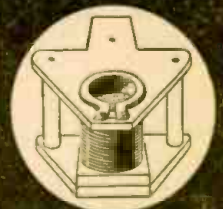

MELTING METAL CRUCIBLE

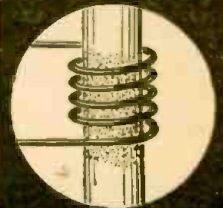

ANNEALING AND NORMALIZING

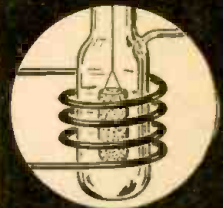

METALLURGICAL ANALYSIS

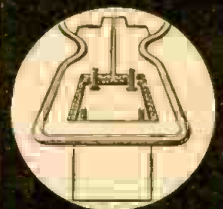

BRAZING AND SOLDERING

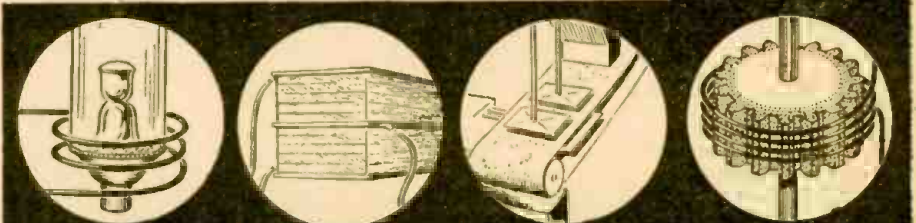

SEALING GLASS TO METAL

BONDING WOOD TO WOOD OR METAL

DEHYDRATING CHEMICALS

HARDENING METALS

(Continued from previous page)

understandable from the foregoing. Bonding wood and pressure gluing are especially important in the aviation industry. Further examples could be given in catalogue form. The field is enormous!

Not the least engaging of future developments will be the application of Capacitative Heating to the home kitchen. Meals

will be cooked in a matter of seconds with all of the major food values retained.

In tomorrow's world the Electronics and Radio Serviceman will have an ever expanding field in both the home and industry. *Radio-Craft* intends to run an article on an experimental 1-Kw Capacitative Heater, with constants and constructional information, in an early issue.

## TEST YOUR SPARK PLUGS ELECTRONICALLY

THE important role of the spark plug in the performance of automobile and aircraft engines makes desirable a simple and quick method of spark plug testing. Such an instrument should determine at once the quality of all the plugs without necessity for their removal from the engine.

Several methods for checking have been made available recently. One originated by Walter van B. Roberts of Princeton, N. J., is especially simple and effective.

Connections are illustrated in the schematic. In series with the battery are the breaker points (shown as a switch) and a transformer primary. A high voltage is induced into the secondary and led through the distributor arm to the various cylinders to successively fire the corresponding spark plugs, one of which is shown.

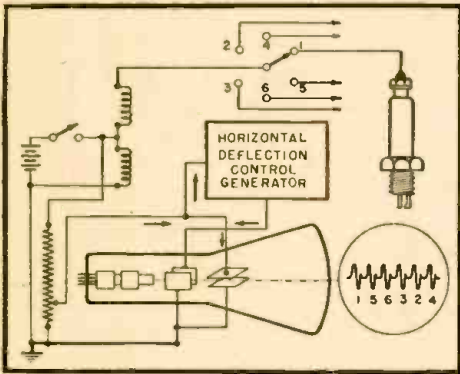

A voltage divider across the primary picks off a suitable voltage. This is applied to both sets of deflecting plates of the oscilloscope. In addition, the horizontal plates are influenced by a deflection control generator connected in series. The frequency of the latter is adjusted to the  $n$ th sub-multiple of the breaker point frequency, where  $n$  is the number of cylinders in the particular engine.

As a numerical example, if the breaker point frequency is 600 sparks per second,

each spark plug will be fired 100 times per second for a six cylinder engine. The voltage in the transformer will rise to a maximum just prior to firing, so that the oscilloscope beam will be deflected vertically and drop sharply as each spark gap breaks down. The sawtooth horizontal deflection will have a frequency of 100 cycles per second.

A typical pattern is shown. Note that an instantaneous picture of all spark plugs is obtainable at once, so that the performance of each may be inspected. The sequence of firing is known and it only remains to determine where the cycle begins. For this purpose any spark plug may be momentarily shorted out while noting which of the peaks is affected.

With little experience, the mechanic can tell at a glance which, if any, plug needs replacement. The instrument should find wide use in airports, garages and manufacturing plants.

A new relay designed to respond to change in frequency has been developed by Westinghouse. It uses a single electromagnet and has two balanced circuits arranged so that a small change in power factor makes large changes in current.

When two parts of a power system joined by a tie line are separated by loss of the connecting line, one section may not have sufficient generating capacity to carry its loads. The frequency will begin to fall off, perhaps so rapidly and to such an extent that the two systems cannot be resynchronized until perhaps a great deal of important load has been dumped. To decrease the amount of load dropped and to do it on a preselected basis instead of in the heat of an emergency, is the function of the new relay.

Relays were built for this purpose before, but they have been much complexed, entailing the balancing of two opposing torques (i.e., two electromagnets) on a single disc. The new relay is far superior in being independent of ambient temperature and in the degree of fineness of adjustment.

## SERVICE PROBLEMS ON THE GYROPILOT



Repairs on the Sperry electronic gyropilots in use on the European battlefronts have been speeded up 500 per cent by a testing panel recently developed by the company's engineers. The complete panel is composed of six components, each for use in making a particular test. By turning up the analyzer and amplifier switch in one of these components, the Army's pilot repair technician can get an accurate check on an instrument's electrical system. Likewise, he can check for breaks or short circuits in the wiring by switching on to a continuity test panel, while a vertical gyro analyzer checks the gyro operation. A turn indicator tester has also been incorporated in the panel.

Official U. S. Army Photo

# At Last!

## U. H. F. RADIO ...

### explained in ONE

## SIMPLE BOOK

### without mathematics

Here is the key that opens the door to a complete and profitable understanding of UHF Radio—so effectively and widely used in war and destined to play so mighty a part in America's peace-time developments.

## EASY TO UNDERSTAND

This masterfully prepared book takes the mystery out of UHF Radio. By simple steps, in plain English, it proceeds from ordinary radio circuits to a thorough understanding of the principles and applications of ultra-high frequency radio. The author explains it in person-to-person style. You'll be amazed at how easy it is to understand and to remember.



# U. H. F. RADIO SIMPLIFIED

by Milton S. Kiver

Associate Instructor—U. S. Army Air Forces—Radio Formerly Instructor in Radio, Illinois Institute of Technology.

## HUNDREDS OF ILLUSTRATIONS

Hundreds of illustrations show every detail and aid in the amazing clarity of the book. Questions on salient points and chapter summaries fix the knowledge in your mind.

## COMPLETE . . . PRACTICAL . . . USABLE

Covers Magnetron Oscillator, The Klystron, Transmission lines at the UHF's, Wave Guides, Cavity Resonators, UHF Antennas, UHF Measurements, Wave Propagation—each explained thoroughly and from the practical, usable standpoint.

## SEND NO MONEY

American industry offers great rewards, now and post-war, to the man who knows UHF Radio. Fit yourself to go places and do things with the knowledge this great book gives. SEND FOR IT TODAY! FREE EXAMINATION. No obligation.

## MAIL THIS COUPON

D. VAN NOSTRAND CO.  
250 Fourth Ave., New York 3, N. Y.

Send me "UHF Radio Simplified". Within 10 days I will either return the book or send you \$3.25 plus a few cents postage. (If you send remittance of \$3.25 with this coupon we will pay the postage. Same return privilege, refund guaranteed.)

Name..... PLEASE PRINT

City.....

Zone No..... State.....  
(if you know it)

Reference.....

Address..... RC 5-45

# TRY THIS ONE!

## EXPERIMENTAL KIT

(Figure 1)

By combining on one chassis a power supply with a number of commonly used parts, a universal experimental unit results and an unlimited number of experiments may be made. "Variable" points of a number of fundamental circuits are brought out to tip jacks and binding posts. It also includes its own soldering iron and testing outfit! Since parts wear out quicker from handling than from use, this unit conserves them.

The sketch shows the general idea. No dimensions or parts list is given since the experimenter will have some of his own ideas to add.

The writer prefers a chassis resembling an inverted table. The legs are cut long enough to clear everything mounted on top, so that the unit may be turned upside down, stood on end or side without danger of damage. A wooden frame with masonite or plywood top will be found convenient. Metal is impractical because of the number of binding posts and tip jacks to be used.

The soldering iron is made from a tube base (4 prong) with leads soldered to filament prongs. One lead terminates in a clip, the other in a metal tube which holds a flashlight cell carbon. To use merely remove the 80 (thus automatically cutting off high voltage during soldering) and insert above tube base into socket.

The second filter choke can be disconnected and a speaker field plugged in. Also the filter condensers can be taken out of the circuit and used with test leads to check another set.

By suitable plug-in, phones or speaker may be used or the amplifier changed from resistance to transformer coupling. Resistor "ST" is used for signal tracer work.

Leads from the plug-in coil socket permit hooking up a number of circuits. For audio, the 500,000-ohm resistor is grounded directly. The condenser across it is .0005 mfd. For use as a signal tracer or

Radio-Craft wants original kinks from its readers, and will award a seven-month subscription for each one published. To be accepted, ideas must be new and useful. Send your pet short-cut or new idea in today!

receiver, it is connected to the 2 megohm resistor.

Among uses of this unit are: R.F. amplifier, audio amplifier, R.F. oscillator, signal tracer and all-wave receiver.

E. E. YOUNGKIN,  
Altoona, Pa.

## BATTERY CHARGER

(Figure 2)

You don't need expensive apparatus to charge your storage battery. You only need a 6 amp. charger bulb and a resistance. The latter may be a 600-watt cone heating element with one-half the resistance wire removed and the remainder stretched to fit the cone form. This arrangement produces a 5 amp. charge rate. If the entire resistance unit is used the charging rate will be about 2 amps. An inexpensive ammeter may be inserted at A to indicate charging rate.



(Figure 2)

To operate: connect clip C to one cell of the battery and as soon as the bulb filament glows, insert plug P into a 110 volt outlet. When rectification starts remove clip. Heat produced by rectification maintains the action.

HAROLD E. BULMORE,  
Newfane, N. Y.

## RELAYS

(Figure 3)

This substitute for a high-resistance relay uses a core from an old audio transformer or filter choke with the core cut as shown in the dotted lines. Earphone pole pieces might be

used also. The core is cut on one side is removed, and the windings left on. Both windings may be connected together for added impedance, but is not necessary, it being possible to use a transformer with a burned out primary by connecting secondary alone.

Windings are not shown in the diagram for the sake of simplicity. The armature is of soft iron to prevent its maintaining magnetism. "C" is a copper rivet. Space between armature and core should be small for higher efficiency. The armature could conveniently be one of the laminations cut out to proper size and shape. The optional spring "S" may be from an old tire valve or dial spring.

The upright for the pivot may also be made up from an old lamination.

The diagram shows the insertion of this unit into the plate circuit of a tube. Other specifications are shown in the accompanying figures.

A Ford ignition coil secondary might be used with a few modifications in design.

GILES M. CRABTREE,  
Peoria, Ill.

## OLD RECORDS

I have some very fine old records over 20 years old which I wanted to play in my record changer. Because they did not have the spiral cut in them at the end, I was unable to use these old records.

By cutting a spiral in them with a pair of calipers, sharpened at one end, I am now able to play them just as well as the new ones. Don't use thick records or you will wreck the record player. This applies only to those old records that are of the same thickness as the modern ones.

L. S. SEAMAN,  
Camas, Wash.

## PHONO PICKUP

(Figure 4)

In looking through my *Radio-Craft* file the other day I came across an article, "MOVING COIL PHONO PICKUP."

I used a discarded volt-ammeter, sometimes used in auto ignition work. The stylus of an old phonograph reproducer is bound and cemented to the meter pointer, after aligning the stylus pivot point with the axis of the moving coil of the meter. One or more rubber bands hold the stylus in the neutral position (vertical). As shown, a bracket is used to support the pickup weight without binding the meter coil pivots.

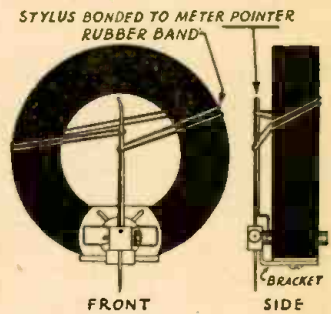

(Figure 4)

The leads from the meter coil are brought out to the primary of a suitable transformer which may be used as counterbalance for the pickup. A voice-coil-to-grid or a ribbon mike transformer may be used.

E. E. YOUNGKIN,  
Altoona, Pa.

## DIAL POINTERS

Necessity was the mother of invention in my case. . . . I needed a dial pointer on the end of a 1/4-inch shaft to hold it removably in place, so I soldered the pointer to a metal tube grid clip and slipped it on the shaft. This fits tightly and is still removable.

Another type of pointer is one which slides on the shaft with a knob in front. This requires the circular type of clip. The pointer is fastened to the clip and slipped on the shaft.

JAY J. LUCAS,  
Robins Field, Ga.

Fig 1, below—The multi-use test layout. Fig. 3, right—Relay made from junkbox parts.

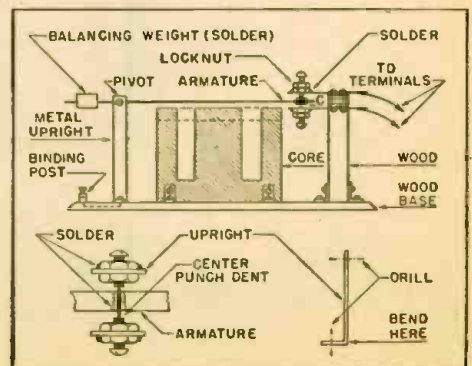
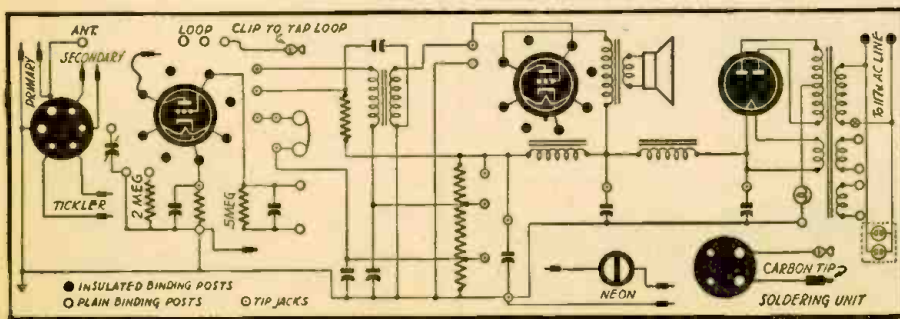



## POLICE RADIO ON V. H. F.

(Continued from page 487)

that a frequency in this particular section would be far superior and more easily controlled from an interference standpoint (from other stations) than any other frequency made available for experimental or operational use for law enforcement."

Previous tests of the use of the 118 Mc. spectrum for two-way radiotelephone communications between a central control station and roving mobile units have also been conducted in Chicago and in Cleveland, Ohio.

In Chicago, with a central control station located at the plant of the Galvin Manufacturing (Motorola Radio) Corporation, and a remote control station, over two miles away in the Graemere Hotel, two-way radiotelephone communication was successfully maintained between three mobile units operating on the North, South and West sides as well as in Chicago's Loop.

Talk-back was clear and intelligible up to distances of twenty miles. At no time, regardless of the location of the roving mobile unit, were any of the difficulties encountered that were so common on the 30-40 megacycle band. Car-to-car was clear up to five miles and reception faded, station-to-car, after twenty-five miles.

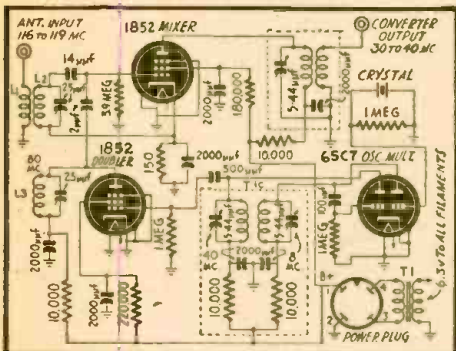

Converter which picks up 118-Mc signals and feeds into a receiver in the 30-40 Mc band.

In Cleveland, 15-watt mobile units were installed in part of the Yellow Cab Company fleet with a 15-watt transmitter located in downtown Cleveland. Here also the same successful reception and transmission were obtained with distances covered comparable to the power used and the height of the antenna. The tests in Cleveland are still continuing but closely conform to those made in both Chicago and Miami.

From the above the following conclusion may be made.

The use of the 118-Mc. spectrum for FM operated two-way mobile radiotelephone systems is practical, efficient and more satisfactory than on any other wave length so far used. It is further concluded that the results of these successful experiments have opened up a whole new series of hitherto unused wave lengths for two-way radiotelephone service available for police and fire departments, public utilities, industrial concerns, trucking fleets and others desiring such service.

The year 1945 has been declared the twenty-fifth anniversary of broadcasting by the National Association of Broadcasters. Special programs and series will be broadcast during the year, to observe the anniversary.

## PORTABLE POWER PROBLEMS

THIS MONTH—FISHER CARBANALYZER



TIME-SAVING carbon content analyses of steel samples—from molten metal to report—take only five minutes with the portable, battery-powered Carbanalyzer, produced by the Fisher Scientific Company. Leading steel firms employing open hearth or electric furnaces quickly make carbon determinations of each batch, achieving close control of quality.

CARBANALYZER, powered by Burgess Industrial Batteries, operates over a range of .05% to 1.50% carbon content and is sensitive to a change of  $\pm .005\%$ . The power requirements of modern control and test instruments are fully met by Burgess Industrial Batteries—the standard of quality for all commercial uses. The types you require may not be immediately available today since industrial battery production is greatly reduced by urgent war needs.

Burgess Battery Company, Freeport, Illinois



SUPPORT THE 7TH! BUY YOUR SHARE TODAY!



# BURGESS BATTERIES

## KLYSTRON CIRCUITS

(Continued from page 480)

grid, the current can be made to increase when the buncher is excited. If the detector grid is sufficiently negative, no electrons reach the collector plate at all, and if it is sufficiently positive, practically all of them may do so.

Mixing may be accomplished by introducing a signal to one of the resonators and connecting a local oscillator to another, if high intermediate frequencies are used. Single resonator mixing may be accomplished if the intermediate frequency is narrower than the bandwidth permitted by the Q of the tube.

Klystrons may be modulated in three different manners—amplitude modulation, frequency modulation, and phase modulation.

Most methods give a combination of amplitude and frequency modulation from which either type may be "extracted" by using combinations of modulations by acceleration voltage and beam current in proper proportions and phases.

By tuning the buncher to one frequency, and the catcher to a harmonic, a frequency multiplier is had in which the efficiency decreases to 48% at the 20th harmonic relative to an assumed 100% for the first harmonic.

More material is becoming available concerning these important tubes, and when they are more available, their versatility will make them very important for countless applications.



See Either or Both of  
These 2 New Books FREE

# ELECTRICIANS HANDBOOK ELECTRONICS

Here's a BRAND NEW, up to the minute Electricians Handbook. A book electrical workers need for reference on the job. Over 5,000 electrical facts—wiring diagrams—essential electrical formulas—latest code rules, tables, charts, and wiring methods. Includes Industrial Electronics data. A practical book every electrical worker can use every day. Pocket size, flexible leatherette cover to stand every day usage.

## Electricians Handbook



See this book FREE for 7 days. It's a book electricians have been waiting for—350 pages "chuckfull" of VALUABLE ELECTRICAL DATA that can earn it's small cost many times over. Price \$2.75, payable after 7 days' FREE inspection.

**ELECTRONICS**  
The QUICK Way  
To BIGGER PAY

GET THESE BOOKS 7 DAYS FREE

To get ahead in Electricity NOW and in the future you should know ELECTRONICS. It is the big pay field for Electrical workers. Coyne's new 400 page book — just off the press is especially written for busy electricians who want practical "on the job" simplified, electronic information. This is no text book — it's a practical book written for practical men. Electricians should find this book a "GOLDMINE" of EASY TO FOLLOW electronic data. Priced at only \$4.95 — payable after 7 days' FREE inspection.

## Send No Money

See both of these books FREE for 7 days. Here's my offer. I'll send either or both books to you for 7 days' inspection at my expense. If you decide you don't want the books, send them back and you owe nothing; if you keep either or both you can pay as outlined in the coupon. Don't delay — SUPPLY LIMITED due to paper restrictions — send that coupon NOW!

## COYNE ELECTRICAL SCHOOL

H. C. LEWIS, President  
500 S. Paulina Street, Dept. 55-T1.  
CHICAGO 12, ILLINOIS

Send me the books checked below on 7-day free trial. I'll either return them in 7 days or pay for them according to the plan I select as outlined here

Coyne Electricians Handbook: 1 Volume. Price \$2.75 after 7 days FREE examination.

Electronics for Electricians & Radiomen: 1 Vol. Price \$4.95 after 7 days Free examination.

**SPECIAL PAYMENT PLAN**  
If you keep both books you can send \$2.00 in 7 days and pay \$2 monthly until \$7.70 is paid.

NAME \_\_\_\_\_

ADDRESS \_\_\_\_\_

CITY \_\_\_\_\_ Zone \_\_\_\_\_ STATE \_\_\_\_\_

If you want books sent C.O.D.—you pay post-man cash price (shown above) check here. Same 100% satisfaction guarantee.

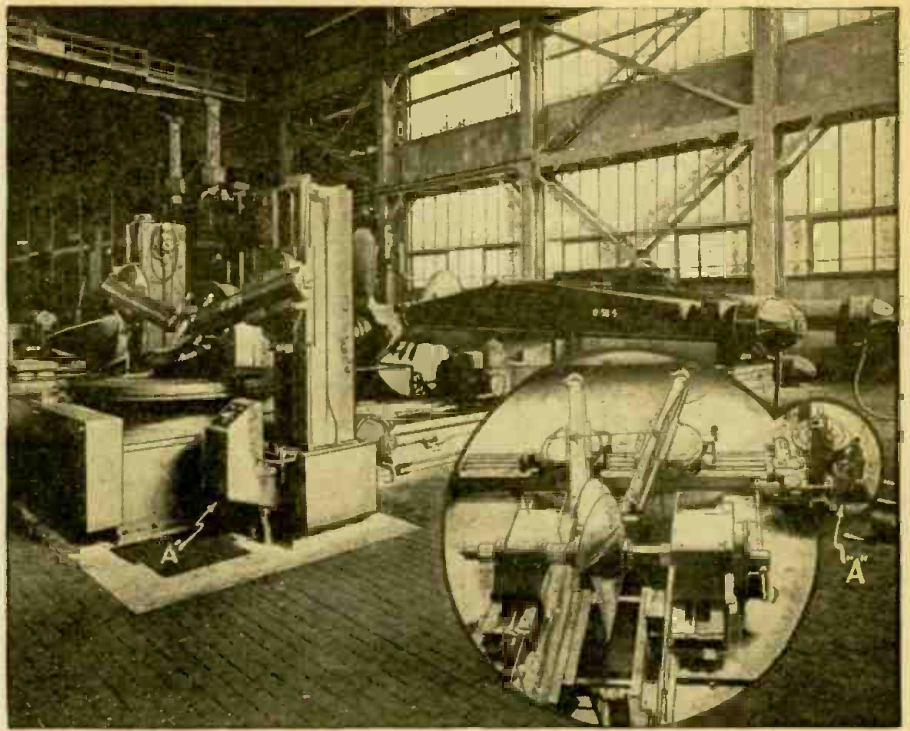

Main picture shows the model propeller. Operator's position is at "A" beside the five-foot model. The insert is a top view which gives a more complete picture of the operation.

## Electron Robot Makes Propellers

A GIGANTIC electronic "pantograph" operates to shape ship propellers, with a 700% saving of time. A steel finger moving lightly over a wood or plaster model guides the huge cutting arms, which shape the propeller. Owing to its curves, this work formerly could not be fully automatic, and a great deal of time-consuming hand work was necessary. Two weeks was the normal time for finishing a large propeller. Now it can be done in two days.

The apparatus may be seen clearly in the photographs. The model is mounted horizontally on a disc between the two columns. Fingers contact its surface. These affect a sensitive instrument, called by Westinghouse a "Silverstat," which regulates the speed of the electric motors. These motors then drive the cutting tools.

The electrons regulate the motors in such a way as to produce a variation of their speed and to make them operate either forward or in reverse. This causes the cutting tool to move in exact proportion to the movement of the tracer finger, duplicating the motion to within one-one-hundredth of an inch of the correct contour. I.Q.

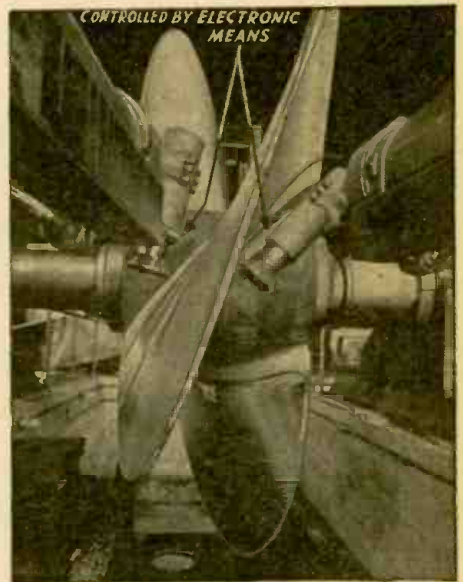

Westinghouse Photos  
Propeller is shaped by large cutting burrs.

## ARMED FORCES TRAIN POSTWAR TECHNICIANS

STAFFS for postwar television and FM stations will be available from the ranks of army- and navy-trained technicians, declared Commander William C. Eddy, U. S. Navy (retired) at the recent Television Broadcasters Association conference.

Their intensive course of training has given these men a complete theoretical grounding, and they have been put to work on apparatus which works on the same principles as television equipment. This combination of intensive theoretical and extensive practical training has produced men who have seldom been stumped, said Commander Eddy. Even under the difficult con-

ditions of Pacific war, where they were compelled on occasion to take over "unworkable" equipment and make it operate efficiently, the trainee-technicians emerged victorious over tropical deterioration and lack of parts in every case. Such training is ideal for men who will have to face new problems in a new technique.

It is the responsibility of television and related branches of the radio industry, warned Commander Eddy, to provide opportunities for the utilization of this talent at the end of the war, to the mutual benefit of the industry and the ex-servicemen concerned.

## SOUND UNITS AND SOUND RATINGS

(Continued from page 488)

to produce sound levels in db at fixed distances from the speaker. The sound levels are referred to the standard zero db sound level.

One thing which must be kept continually in mind when referring to sound and electrical db is the reference level. Both are computed using the same basic formula but their zero levels, .0002 dynes per square cm. for sound and 1 milliwatt in 600 ohms for electrical energy, are different.

### A TYPICAL EXAMPLE

To illustrate how these various ratings may be correlated in a sound system let us consider an example.

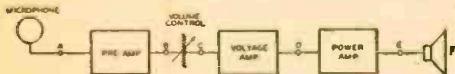

Fig. 1—Points of measurement in a system.

Referring to Figure 1 we see the elements of a complete sound system. Assume we wish to pick up sound on the high fidelity microphone and reproduce it over the loud-speaker with a sound level of 100 db. at a point 30 feet ahead of the speaker. We know that this particular microphone produces an output level at the point A of -55 db. below the standard zero level of 1 milliwatt. The microphone is connected to a preamplifier having a voltage gain of 25 db. Thus with the input voltage level to this preamplifier of -55 db. and a voltage gain of 25 db. we have an output level of -30 db. at the point B. The volume control is the type which offers no loss when turned full-on but to allow a range for normal operation we must turn it to a point where the voltage loss is 25 db. Thus at the point C we again have a level of -55 db. Our next amplifier, commonly called the "Voltage Amplifier," has a voltage gain of 55 db. Thus at the output of this amplifier (Point D) the Voltage level is "0" db. One of the given requirements is that we produce a sound level of +100 db. 30 feet from the loud-speaker at Point F. The amount of electrical energy necessary at the voice coil of the loud-speaker (Point E) to produce this sound level will depend on the design of the speaker used.

This information is obtainable from the manufacturer in the form of tables giving the wattage required for a given sound level at a specified distance from the speaker in the presence of a given amount of background noise.

For the example we choose a loud-speaker with a voice coil impedance of ten ohms and a requirement of ten watts input to produce the necessary sound output. Our Power Amplifier must therefore produce ten watts in this 10-ohm circuit.

From Ohm's law we calculate that the voltage at the amplifier output is

$$E = \sqrt{P \times R}$$

or  $E = 10$  Volts at Point E. At the input to our Power Amplifier we have a voltage level of 0 db. Our standard reference level is one milliwatt in 600 ohms. From Ohm's law  $E = \sqrt{P \times R} = \sqrt{.001 \times 600} = .78$  volts. This voltage  $E = .78$  is the actual



Fig. 2—Gain calculations for an amplifier.

## RIDER VOLUME XIV COVERS 1941-42 RECEIVERS



I have always had a warm spot for "Duffy's Tavern" because the first program I carried was its first sponsored broadcast. Ah, I was young, strong—and what a tone I had in those days.

Today, however, after the beating I've taken during the past few years—well, as "Archie's" song suggests "Leave Us Face It." I'm in bad shape. I ought to be in the radio repair shop this very minute, along with many of my con-

temporaries who just couldn't take it any longer. The trouble is that our serviceman hasn't heard that Rider Manual Vol. XIV covering 1941-42 receivers has been published. So, he is wasting a lot of time trying to diagnose the ills of 1941 and 1942 sets when the servicing data in Volume XIV could lead him right to the causes of the troubles—and quickly.

If your jobber is out of Volume XIV or any other number please bear with him. WPB paper restrictions, you know,

### RIDER MANUALS (14 VOLUMES)

Volumes XIV to VII . . . . .	12.50 each volume
Volume VI . . . . .	9.50
Abridged Manuals I to V (1 vol.) . . . . .	15.00
Automatic Record Changers and Recorders . . . . .	7.50
<b>OTHER RIDER BOOKS YOU NEED</b>	
The Cathode Ray Tube at Work Accepted authority on subject . . . . .	4.00
Frequency Modulation Gives principles of FM radio . . . . .	2.00
Servicing by Signal Tracing Basic Method of radio servicing . . . . .	4.00
Servicing Superheterodynes . . . . .	2.00

The Meter at Work An elementary text on meters . . . . .	2.00
The Oscillator at Work How to use, test and repair . . . . .	2.50
Vacuum Tube Voltmeters Both theory and practice . . . . .	2.50
Automatic Frequency Control Systems —also automatic tuning systems . . . . .	1.75
A-C Calculation Charts Two to five times as fast as slide rule . . . . .	7.50
<b>Hour-A-Day-with-Rider Series—</b>	
On "Alternating Currents in Radio Receivers"—	
On "Resonance & Alignment"—	
On "Automatic Volume Control"—	
On "D-C Voltage Distribution" . . . . .	1.25 each

**JOHN F. RIDER PUBLISHER, INC. 404 FOURTH AVE., N.Y. 16, N.Y.**  
Export Division: Radio-International Corp., 13 E. 40th Street, New York City      Cable: ARLAB

# RIDER MANUALS *are complete* IN 14 VOLUMES

voltage at our Power Amplifier input. We now have the voltage input to our Power Amplifier  $E = .78$  and the voltage output  $E = 10$ .

### CALCULATING THE GAIN

Our output circuit is a 10-ohm impedance. Therefore we will insert an imaginary transformer to make it possible to measure the output voltage across a 600-ohm-impedance like the input. See Fig. 2. Since the voltage ratio in a transformer is equal to the square root of the impedance ratio, 600-10 or 60-1, the primary voltage is the square root of 60, or roughly 77.5 volts.

$$\text{The decibel rating is then } 20 \log \frac{77.5}{.78}$$

For practical purposes it is convenient to round this off to  $78/.78$ , or 100. Since the logarithm of 100 is 2, the decibel rating is  $20 \times 2$ , or 40 decibels.

Thus our Power Amplifier is required to have a voltage gain of 40 db. to supply the needed output.

All of our calculations have been on the basis of voltage. This is common because it is more practical to measure voltages at different points in a sound system than power at the same points. Only at the Power Amplifier output was it necessary to consider actual power and this in turn was converted to equivalent volts for further calculations.

The basic sound level of .0002 dynes per square cm is an accepted standard while its electrical counterpart, 1 milliwatt in 600 ohms, has not been universally recognized. If equipment ratings are based on other reference levels, care must be exercised in computations. It is hoped that eventually all other zero levels except 1 milliwatt in 600 ohms will be discarded in the interests of standardization.



**10,000 PARTS** immediately available on priorities.

### SAME-DAY SERVICE

*Trained expeditors fill your order the day we receive it.*

**SINCE 1922** we have been known as reliable and responsible jobbers, wholesalers and manufacturers, of radio and electronic equipment.

## Radio Wire Television Inc.

100 SIXTH AVE., DEPT. A-5, NEW YORK 13, N. Y.  
BOSTON, MASS. • NEWARK, N. J.

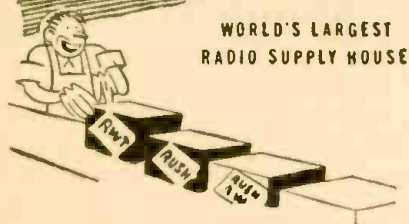

**WORLD'S LARGEST RADIO SUPPLY HOUSE**

Originators and Peacetime Marketers of the celebrated

# Lafayette Radio

Write today for our bargain flyers and special bulletins.

# Progress In Invention

Conducted by I. QUEEN

## OVERLOAD PROTECTION

Patent No. 2,364,136

**RELAYS** are often used for protection of vacuum tube circuits, but they have the disadvantage of throwing the circuit out of operation even on slight, temporary overload. G. L. Graveson of Amityville, N. Y., and C. R. Keith of Maplewood, N. J., have developed a method using a thermistor, which operates only when the tube plates reach a predetermined temperature. It is especially useful in connection with such circuits as class-C oscillators.

The thermistor (T) resistance varies with temperature. It is placed in shunt with a leg of a phase-shifting bridge, and is positioned adjacent to the tube plates. Radiation from the latter causes an out-of-phase voltage to be applied to the rectifier grids, decreasing the voltage output. As soon as normal conditions return, the grids are in phase with the plates (of the rectifier tubes) and a normal voltage output is again available.

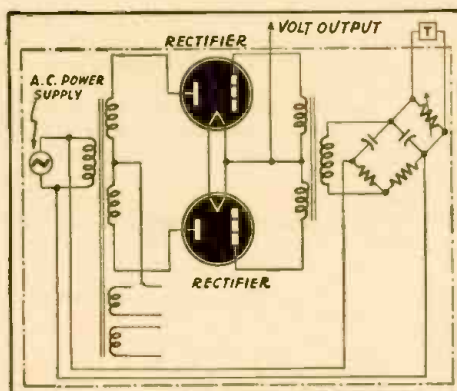

## SENSITOMETRY

Patent No. 2,361,447

**I**N photographic work and film recording film emulsions are compared and studied by means of densitometers. This circuit plots an H & D curve directly on an oscilloscope screen permitting rapid determination of film characteristics. It is the invention of Judd O. Baker, Medford Lakes, N. J.

The film is secured on a drum D inside of which is mounted a photocell. One film edge overhangs so that light from a bulb B may be focussed upon it. On the same shaft is mounted the movable contact of a potentiometer P (see illustration).

The photocell output (determined by the film transmission) is amplified and connected to the oscilloscope vertical plates, while the potentiometer output goes to the horizontal plates. The horizontal beam displacement (sweep) is linear and depends upon the potentiometer arm, while the vertical displacement corresponds to the film transmission. As the motor rotates a density curve is traced out by the electron beam on the tube screen.

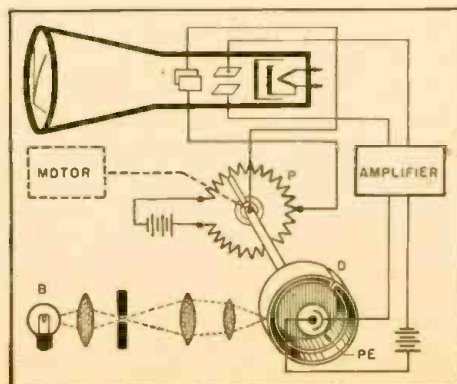

## U.H.F. F.M. DETECTOR

Patent No. 2,367,764

**T**HE optical characteristics of ultra-high frequencies are made use of by Warren R. Ferris in his invention relating to FM signal reception.

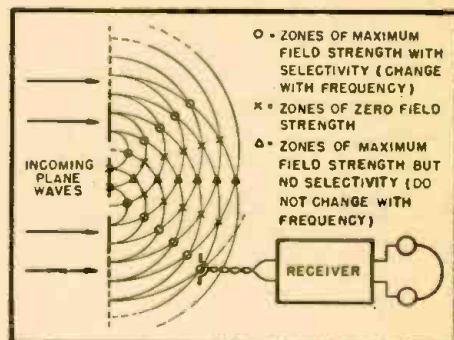

Incoming waves strike a metal baffle containing slits. Their width may be equal to the wave length of the signals and their spacing several times greater. As a result of spreading, cylindrical waves are formed beyond the baffle, resulting in weakening and strengthening of energy at different points, as shown. Positions of maximum and minimum strength will vary with the frequency.

The system is described as it would be used with waves in the order of one centimeter long, but is adaptable to longer or shorter waves.

A dipole is placed at a point of maximum signal at a frequency representing maximum F.M. deviation. Then as the signal varies in frequency each side of the carrier, received signal amplitude changes and may be detected by any U.H.F. means. A large number of slits and dipoles may be used to increase sensitivity to the extent desired.

Warren R. Ferris, East Orange, New Jersey, assignor to Radio Corporation of America.

## TWO WAY AMPLIFIER

Patent No. 2,366,011

**W**HERE two-way transmission must take place as in long distance telephony, special precautions must be taken to avoid feedback and oscillation.

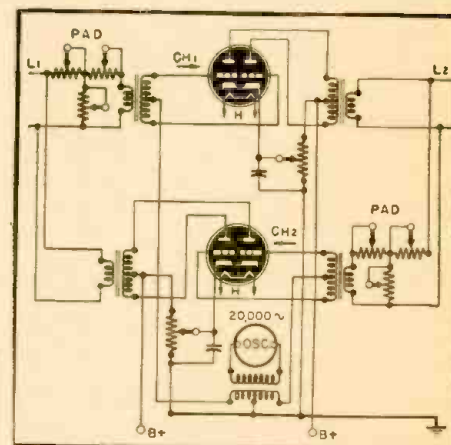

tion because of interaction. H. L. Donaldson of Chicago has a simple solution to this problem.

A super-audible oscillation alternately biases each of the two amplifiers shown. In other words, channel 1 operates while Channel 2 is cut off during one alternation of the 20,000 cycle oscillation, and vice versa during the next alternation. Thus no feedback can occur. The high frequency does not interfere with the audio frequencies being transmitted.

While intended for telephone use, in the manner of the familiar two-way repeaters, this circuit might well be adapted to a line or carrier office intercommunication system.

## BROADCAST EQUIPMENT

(Continued from page 495)

peaks, due to cut-off. The result is that both tubes work at a much greater proportion of their ratings, with increased efficiency due to full-load operation.

This cannot be accomplished merely by connecting the tubes in parallel and applying unequal values of bias, because the output of the peak tube would not combine in proper proportion with that of the carrier tube. By means of Doherty's ingenious circuit, the combination *does* become additive. Distortion in this system is rather high, but by the use of inverse feedback it is possible to meet all the requirements of high-fidelity broadcasting.

Today's broadcast engineer has many opportunities to encounter this circuit, as it has been incorporated in all Western Electric broadcast transmitters of 1000, 5000 and 50,000-watts power since 1938.

A modified form of negative feedback as applied to broadcast transmitters permits a high-fidelity modulation envelope by reducing audio distortion and noise created within the transmitting equipment. Hum and noise may be reduced to as low as 65 db below the 100% modulation level (even with A.C. on all filaments) a value which is 15 to 25 db better than the FCC standards of good broadcast engineering practice. Harmonic distortion may also be kept well within the FCC minimum, usually to around 2 or 3% at 100% modulation.

The application of degenerative feedback to broadcast transmitters is similar in principle to its application in audio amplifiers. It is well known that if a portion of the output signal of an amplifier is returned to the input and combined with it in reverse phase, the gain of the stage is reduced. Furthermore, if the feedback signal contains distortion and noise components not present at the input, it will tend to cancel such noise and distortion, provided that it reenters the circuit very nearly 180° out of phase with the input signal.

One means of accomplishing this in radio-telephone transmitters is to apply the feedback signal to a linear rectifier designed for minimum phase shift, thereby developing an audio signal which is an exact reproduction of the modulation envelope. This is then introduced into the first speech amplifier in the same way as any other audio-frequency feedback.

When operating a transmitter in this manner, it must be borne in mind that the gain of the audio system is reduced by the amount of degeneration used. Thus if the feedback is lost, the faders must be readjusted to prevent overloading.

An alternative feedback arrangement which is applicable only to unmodulated amplifiers consists of merely coupling the output and input tuned circuits in such a manner as to cause degeneration. The main object in this case is the reduction of inate noise, as no modulation is present.

In either case, when the voltage fed back to the input is some value other than 180° out of phase with the input, less cancellation of noise and distortion will result. This is particularly true when the phase shift is less than 90° or more than 270°; and when the phase difference is near 0° or 360°, stabilizing circuits are required to prevent strong oscillations in the entire transmitter.

Neutralization is our next topic for discussion, to be followed by a consideration of modulation equipment.

# G-E UNIMETER . . .

**T**HE UM-4 is an invaluable instrument for service work. Not only is it useful in common radio and industrial applications, but also for the higher voltages employed in cathode-ray tube work and the very high voltages encountered in television. Special jumbo prods are provided for protection on high voltage work. Two-tone scales permit quick and accurate readings. Write: *Electronics Department, General Electric, Schenectady 5, N. Y.*

Electronic Measuring Instruments

**GENERAL  ELECTRIC**

177-D3

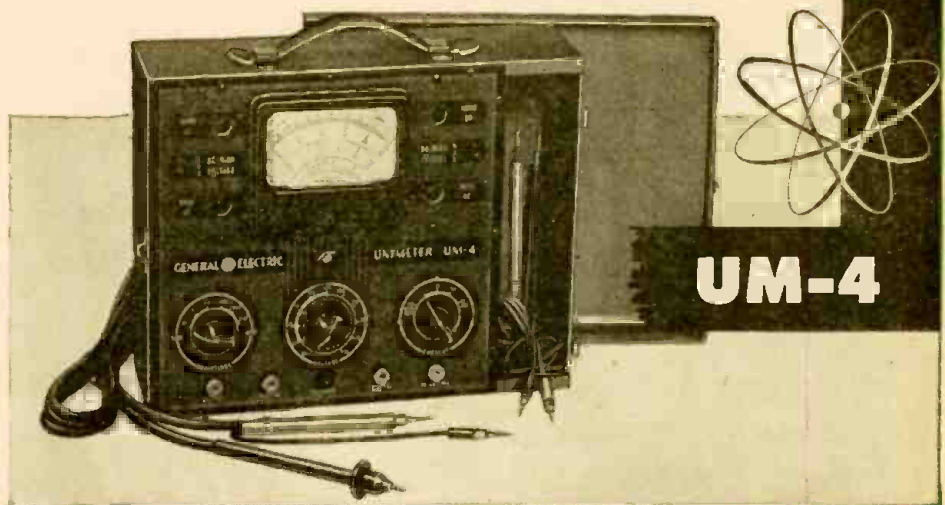

**AVAILABLE NOW!**  
**FOR DEALERS & SERVICEMEN**

**IMMEDIATE SHIPMENT  
FROM STOCK!**

**No Priority Needed for  
Dealers and Servicemen**

**PROVIDES EASY ACCESS TO COM-  
PONENT PARTS . . . FINGER-TIP  
CONTROL**

The new Acro Chassis Cradle has been designed and built to help busy industries smooth out production, simplify and speed assembly and inspection, and hasten deliveries of their products. It will definitely effect important economies in time, material and man-power.

One example of how the Cradle is used to great advantage is illustrated at left. Photo shows the Cradle holding an electrical assembly in an easy-to-get-at position for quick inspection or repair. All component parts and connections can be checked without danger of damaging tubes, coils and other delicate parts, as so frequently occurs by dropping and bumping during ordinary handling. More than that, units can be assembled much more rapidly and with greater accuracy with the new Cradle, because it allows workers to use both hands, and permits them to position the working area to their convenience. Work can be rotated and locked in position by a "flick" of the finger.

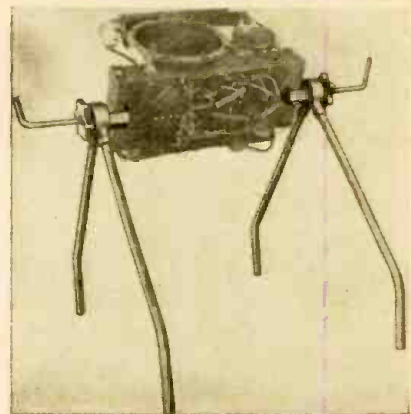

**ACRO CHASSIS CRADLE**

**\$4.95 WITH STANDARD CLAMPS**

**STRAIGHT CLAMPS** for sub-panels and other flat pieces:—These clamps also enable you to use your cradle for a reel. \$2.50 per pair. Additional **STANDARD CLAMPS** \$2.50 per pair.

**RIGID CONSTRUCTION**

The Acro Chassis Cradle is made of cadmium plated steel and white metal and consists of the supporting legs and locking clamps that hold the work in a vise-like grip. Adjusts to any position by finger-tip control and is equipped with an automatic stop. Its simple, sturdy construction assures years of trouble-free service. . . . Obtain at least one of these low-cost units at once. Don't wait—act now—Send your order today!

**RADIO ELECTRIC SERVICE CO.**  
OF PENNSYLVANIA  
N.W. COR. 7th & ARCH STS.  
PHILADELPHIA 6, PENNA.

Phone:—  
**LOMBARD 6177**  
**LOMBARD 1951**

# How to Repair Electric Clocks

By HOMER L. DAVIDSON

WITH a few inexpensive tools, the average radio serviceman can repair most of the electric clocks brought into the shop. Practically all of these clocks are based on the synchronous motor. The non-selfstarting motor requires a twist of the wrist to give it the starting torque. They will then run until the current goes off and will not start again but will heat up and hum. The most expensive clocks have a starting winding which consists of two copper "shading rings" located in the leg of the iron lamination. These type of motors generally contain a sealed unit.

The sealed unit should be sent in to the clock manufacturing company to be repaired. The oil in this unit may run out during the summer months and sometimes will chill and pack during cold weather. When shipping this sealed unit to the manufacturer, be sure and give all model numbers, voltage numbers and correct frequency (60, 50 or 25 cycles) and address.

In handling the elaborate clock cases, the repairman should be very careful to prevent scratches and marring of surfaces. Especially great care should be exercised where the clock is built in grandfather-clock cases, lighthouses, statues and models, ships and chimes, etc. The latter generally triggers a striking arm upon long-tone chimes which ring the half- and full-hour periods.

It is best to have at hand two small screwdrivers, side cutters, long nose pliers, soldering iron and a few inexpensive testers. A continuity tester will check the field or transformer winding, alarm solenoid and A.C. line cord. This simple tester is shown in Fig. 1. It is always handy to have a small ohmmeter around for the above checks also.

## TROUBLE ANALYSIS

The following trouble indications should be tested as follows:

- 1—Visual indications.
- 2—Magnetic field check.
- 3—A.C. cord inspections.
- 4—Sealed unit and bearings.

Actually the first thing we notice about the clock is that it isn't running and our eyes quickly check over the assembly. You will usually find that small simple repairs such as frayed cords, broken cord connections, plug connections, and poor contact

points are the only needs. The most frequent repair on electric clocks is the 110 volt A.C. power cord. This generally breaks at the male plug or where it enters the case, resulting in a sharp bend. If by visual inspection the cord shows no sign of weakness, we can place a metal screwdriver on the lamination near the rotating armature. A small vibration should be felt if the A.C. is getting to the field coil.

If by chance the A.C. power cord is good, the trouble must lie in the connections from cord to field or an open field coil.

The field coil can be checked for continuity in the same manner. An open solenoid is generally caused by excessive heating. The solenoid should always be

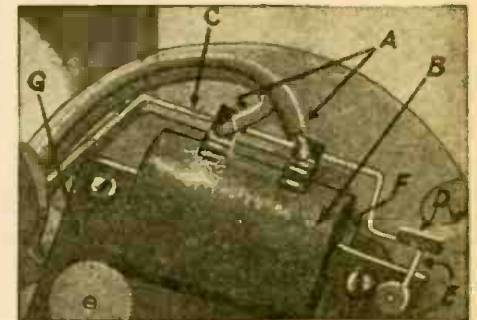

A—A.C. terminals. B—Field coil. C—Alarm striker reed. D—Alarm release. F—Bell.

removed from the lamination assembly before the brown paper is removed from the windings. All of the turns are uncoiled until the open is found. The connection is soldered, taped and rewound again. If these windings are burned, they should be rewound with new wire of the same size. If the solenoid sets up a magnetic field, we then suspect the sealed unit in the non-selfstarting clock.

A common fault is bad bearings on each end of the revolving armature. In the cheaper clocks, these are nothing more than bakelite bearings which are molded in the case. These bearings cannot be replaced. The clock is so cheap that repairs would cost more than it is worth. The better-built clocks have metal bearings and should be worked on by the jeweler only.

Fig. 1—All that is needed for electric clock checking. Fig. 2—Circuit of standard electric alarm clock. Fig. 3—Clock with separate alarm solenoid. Fig. 4—Timing action for alarm.

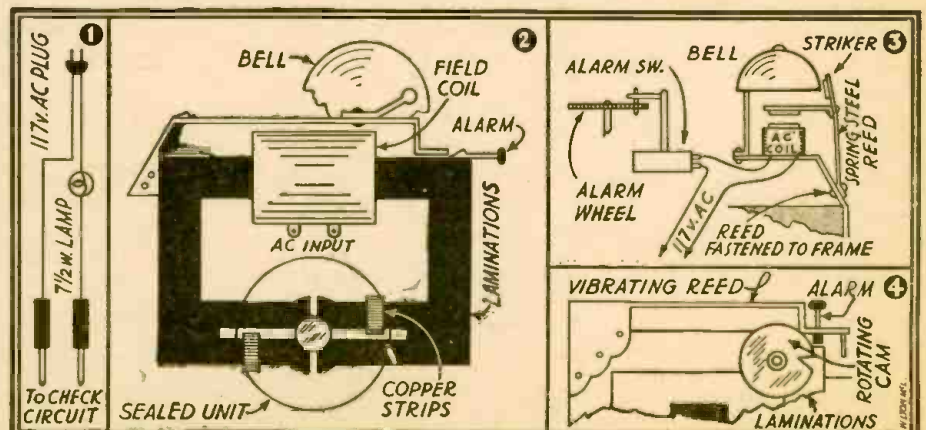

## MODEL 504-A

# Tube and Set

## TESTER....

★ **THE PORTABLE LAB THAT GIVES YOU—*Everything!***

- ★ Design proven by over 5 years production of thousands of this model.
- ★ Operation as simple as ABC. Multifunction push-button switches do all work. Simply "follow the arrows" for tube checking. No roaming test leads for the multimeter.
- ★ Open face wide scale 4 1/4-inch rugged meter built especially for this tester—500 microampere sensitivity.
- ★ Each AC and DC range individually calibrated.
- ★ Professional appearance. Solid golden oak carrying case.
- ★ Guaranteed Rectifier.

### SPECIFICATIONS

DC MICROAMPERES: 0-500  
 DC MILLIAMPERES: 0-2.5-10-50-250  
 DC AMPERES 0-1-10  
 DC VOLTS—1000 OHMS PER VOLT: 0-5-25-100-250-500-1000-2500  
 AC VOLTS 0-8-10-50-250-1000  
 OUTPUT VOLTS: 0-5-10-50-250-1000  
 OHMMETER: 0-200-2000-20,000 OHMS 0-2-20 MEGOHMS  
 BATTERY TEST: Check Dry Portable "A" and "B" Batteries Under Load  
 CONDENSER CHECK: Electrolytics checked on English Reading Scale at Rated Voltages of 25-50-100-200-250-300-450 volts.  
 TUBE TESTER: Emission type with noise test, floating filaments, easy chart operation. Checks all receiving type tubes.  
 POWER SUPPLY: 115 volts 60 cycle. Special voltage and frequency upon request.

# SUPREME

SUPREME INSTRUMENTS CORP.  
Greenwood, Miss., U.S.A.

(Continued from previous page)

### ALARM CONTROL

The most common alarm controls are shown in Figs. 2 and 4. There are also alarms which have a separate solenoid for magnetic vibrations. This type is shown in Fig. 3. The vibrating reed in Figs. 2 and 4 is attracted to the laminations by the clock's own field winding. When the alarm lever is pulled out and the revolving notched cam has pulled around to the correct hour, the vibrating reed will start striking against a metal bell or clock flanged frame.

These reeds are insulated from the fixed lamination with small strips of aluminum or copper. Another type of alarm is shown in Fig. 3, where a solenoid circuit is closed by a switch rotary on a geared shaft of the clock. The switch will close at the alarm hour. This type of solenoid hooks directly across the 110 volt A.C. line. An advantage of this type alarm over the others is that it is much louder.

The vibrating tapper is checked by visual inspection of the rotating cam. Look for bent parts. The solenoid alarm can be checked in the very same manner as the field coil. Besides checking solenoid continuity, the switch contacts should be checked and cleaned. These contacts will sometimes arc and burn off due to dirty contacts. Be sure and wipe off all excess dirt and grease found on the inside of the clock movements and case. Do not oil unless necessary, then use a very fine grade of oil. Never use oil on the clock jewel bearings. Take it to the jeweler!

With a little judgment and care, electric clocks can be repaired very satisfactorily. Their mechanisms are extremely simple, and technique and tools are identical with those used in radio receiver repair.

**HALLICRAFTERS**

**★ HALLICRAFTERS**



## RECEIVER HEADQUARTERS *for the Nation*

**B**EFORE the war Bob Henry served the amateurs as the world's largest distributor of communications receivers.

Now Henry Radio is Hallicrafters receiver headquarters for the Nation at war. Hallicrafters Receivers can be supplied on AA-1 priority. I can usually supply SX28As at \$223.00, S-39s at \$110.00, SX-25s at \$94.50, and PM-23 speakers at \$15.00 at once. It takes longer to supply other models.

Soon, it is hoped, non-priority orders can be filled and Bob Henry can become again Hallicrafters headquarters for the nation at peace.

I have stores at Butler, Missouri, and at 2335 Westwood Blvd., Los Angeles 25, Calif.

*Your orders and inquiries are invited.*

**Bob Henry, W9ARA**  
**HENRY RADIO SHOPS**

Butler, Mo. and Los Angeles, 25, Calif.

### COMPLETE STOCKS

I have in stock some Hallicrafters receivers available for immediate delivery on priority and the following parts without priority: meter rectifiers \$1.95, transmitting tubes, transformers, resistors, condensers, panels, headsets, etc. Your orders and inquiries invited.

**"WORLD'S LARGEST DISTRIBUTOR OF COMMUNICATIONS RECEIVERS"**



**HALLICRAFTERS ★ HALLICRAFTERS**

# FIX ANY RADIO

## Amazing New Invention

**Simplified  
Radio  
Servicing**

NEW  
1945 EDITION

**REPAIR ANY RADIO IN MINUTES**

Learn time-saving trouble-shooting short-cuts; find any radio fault with ease. Follow the tests shown on 24 large circuit blueprints. Over 1,000 practical repair hints. Hundreds of simplified tests using a 5c resistor and any filter condenser. Introductory material for beginners and to serve as review for experienced radio men. Several chapters on test equipment. Complete plan in manual form, 64 job-sheets, data on all tubes, size: 8½ x 11 inches. Sold on *no-risk* trial. Money-back guarantee. Use coupon to order →

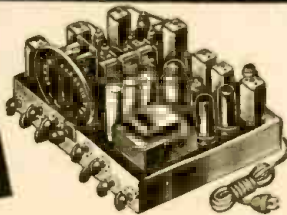

This newly developed method tells you how to locate the source of trouble in any radio without equipment. Make needed tests, measure voltage, trace the signal, by using only a 5c resistor, small condenser, and a crystal detector. Inject signals without any signal generator. Test parts by the new *Comparison* method. Test tubes without equipment. Repair any radio expertly following illustrated, simplified plans. Improve your radio servicing ability. Data on all sets, portables, AC-DC, FM, recorders, intercoms, P.A. Examine and apply the plan for 10 days without obligation or risk. Send coupon today →

Find radio faults with a new simplified method. Repair radios in minutes instead of hours. Revolutionary, different *Comparison* technique permits you to do expert work almost immediately. Most repairs can be made without test equipment. Simple point-to-point, cross-reference, circuit suggestions locate faults quickly and easily. You may try this unique plan without risk or obligation.



Developed by  
M. N. Beitman,  
radio engineer,  
teacher, author,  
& serviceman.

COMPLETE PLAN  
**\$1.50**

**TRIAL ORDER COUPON**

**Supreme Publications**

PUBLISHERS OF RADIO BOOKS, MANUALS, AND DIAGRAMS

9 S. Kedzie Ave.

Chicago 12, Illinois

Ship postpaid the new complete Simplified Radio Servicing manual for 10 days' examination. I am enclosing \$1.50, full price. I must be entirely satisfied or you will refund my total remittance.

NAME: .....

ADDRESS: .....



## There's No Priority On A BETTER Job!

ADD CREI Technical Training to Your Practical Experience—THEN Get That BETTER Radio Job You Want!

CREI home-study training in practical radio engineering enables you to go after—and get the better jobs that mean something in radio. There's no priority on success—but the better jobs are "rationed" to those men who have the necessary technical ability.

Jobs that provide security—jobs that will mean something long after "tomorrow" has come and gone—must be won and held on ability. The men who will retain the important radio-electronics engineering positions after the war is over are those men whose positions are essential—whose abilities are specialized.

More than 10,000 professional radiomen have enrolled for CREI home study courses in Practical Radio-Electronics Engineering. Today, hundreds of ambitious men, just like yourself, are taking our specialized spare-time training to give them the technical skill to supplement their present ability . . . to earn a better living . . . and to create a secure place for themselves in the great postwar world of radio and electronics.

Don't say YOU haven't the time. CREI courses are designed to be suited in the most crowded schedules. You can study a few hours a week without interfering with your present work. So, write for all the facts now—for this is the time to make sure that your preparation for post-war success shall not be "too little, too late!"

### ● WRITE FOR NEW, FREE 36-PAGE BOOKLET

If you have had professional or amateur radio experience and want to make more money—let us help you qualify for a better radio job. TELL US ABOUT YOURSELF, so we can intelligently plan a course best suited for your needs.—PLEASE STATE BRIEFLY YOUR BACKGROUND OF EXPERIENCE, EDUCATION AND PRESENT POSITION.



## CAPITOL RADIO ENGINEERING INSTITUTE

Home Study Courses in Practical Radio-Electronics Engineering for Professional Self-Improvement

Dept. RC-5, 3224—16th St., N. W. WASHINGTON 10, D. C.

Contractors to U.S. Navy—U.S. Coast Guard—Canadian Broadcasting Corp.—Producers of Well-trained Technical Radiomen for Industry

## ARMY RADIO COMMUNICATIONS

(Continued from page 490)

crease signal strength over unusually long or noisy transmission paths, where high power is advantageous.

On the second day after the initial landing on the Normandy coast, the cross-channel circuit illustrated above began operation, providing initially facsimile transmission of air reconnaissance information on military objectives from a Tactical Air Command Headquarters to the invasion forces. Shortly thereafter full multichannel telephone and teletype facilities were provided from Central Headquarters in England to the field commanders of the First U. S. Army in France. Following these outstanding uses, other armies, as they became operational on the continent, extended similar multichannel radio facilities to their Corps, from their Corps to Divisions and between Corps within each army. The Air Forces likewise linked their base command establishments by means of similar radio circuits providing the establishment of equivalent wire circuits.

As the Armed Forces progressed across France additional radio relay facilities were established for both tactical requirements in the forward areas, and for administrative purposes in the rear Communication Zone. With the installation of additional cross-channel facilities, and of wire lines and other radio circuits on the continent, the radio relay systems became part of a completely integrated and comprehensive net-

work of telephone, teletype and telegraph circuits covering an area in Europe equivalent in size to that from New York to Chicago and from Detroit to Atlanta. Through this integration, the radio systems became vital links in the network in providing primary circuits under enemy fire which took prohibitive toll of lives and material during attempted wire installations, or over terrain impassable to wire lines; and also emergency circuits in the event of traffic overloads or failures of other facilities.

In citing the importance of this equipment as an emergency facility during a failure of the main cable system across France as a result of combat operations, the Chief Signal Officer, Major General W. Rumbough, European Theater of Operations, stated, "In spite of this very serious cable interruption, and I do not think any single trouble could have been worse, we handled 2709 messages —, that is nearly 2 messages per minute throughout the 24 hours."

The logistical advantages accruing from the use of radio relay communication system over the "spiral-four" cable system, as illustrated in Fig. 2, have been the principal factors through which this type of equipment has achieved its favorable reception and praise in relieving transportation, installation and maintenance problems. Greatly expanded commercial use of the principles for post-war applications are indicated.

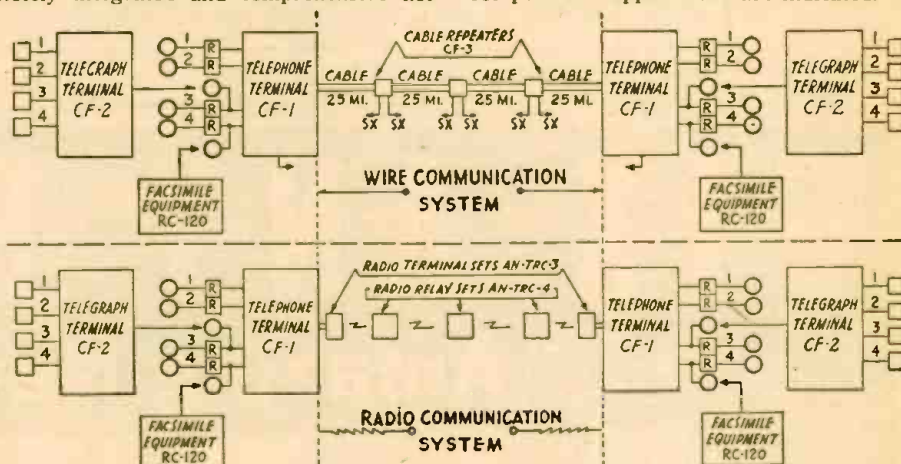

Fig. 2—Comparison, wire and VHF communication facilities, U.S. Army multi-channel systems.

### WIRE COMMUNICATION SYSTEM

1. Approximately 94 ship-tons of equipment required for a fixed system length of 100 miles.
2. Requires large force of men and materials for installation and maintenance.
3. Subject to interruption from enemy action, equipment failure, and electrical interference at an infinite number of points along cable route.
4. Not suitable for transmission over large bodies of water or territory controlled by the enemy.

### RADIO COMMUNICATION SYSTEM

1. Approximately 25 ship-tons of equipment

### FOUR HUNDRED FM APPLICATIONS EXPECTED

FM Broadcast station applications reached the total of 353 last month, says Miles Loucks of Frequency Modulation Broadcasters.

The FCC expects a flood of applications as soon as the war ban on materials and manpower is lifted. Estimating 1200 com-

mercial FM, 1200 Standard broadcast and 450 non-commercial FM applications in the first year, the commission is asking an increase of 10 employees in the broadcast division of the engineering department, three in the accounting department and 14 in the law department.

2. Installed, operated and maintained by a small force of men without special equipment or materials.
3. Subject to interruption from enemy action, equipment failure and radio interference at 5 points only.
4. Well adapted for transmission over reasonably large bodies of water or portions of territory controlled by the enemy.

mercial FM, 1200 Standard broadcast and 450 non-commercial FM applications in the first year, the commission is asking an increase of 10 employees in the broadcast division of the engineering department, three in the accounting department and 14 in the law department.



## VOLTAGE REGULATORS

(Continued from page 489)

load voltage to rise. By suitably choosing operating parameters the circuit conditions can be set.

A different form of control action is used in Fig. 6. A D.C. potential is applied to the grid of the tube. If the output voltage of the supply rises, there will be a tendency for the grid to go more positive. When this happens, an increased amount of current tends to flow in the plate circuit of the tube and through the cathode resistance. Any increase in the voltage drop across  $R_3$  will tend to reduce the plate current since, with increased drop across  $R_3$ , the

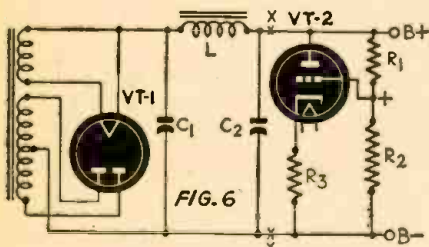

FIG. 6

grid is made more negative with respect to the cathode. Accordingly, a certain amount of degenerative action and stabilization may be expected. In effect we have a shunt resistance across the output of the B supply, between the B plus and B minus terminals, consisting of the tube's plate-cathode resistance in series with  $R_3$ . Somewhat better regulation may be obtained by substituting a special bias battery for  $R_3$ , thus maintaining constant voltage between grid and negative terminal.

A completely electronic voltage regulator is shown in Fig. 7. The voltage-regulator tube of Fig. 6 is used in conjunction with another,  $VT_2$ , which acts as a variable resistor. The action is the same as Fig. 6, as far as the voltage-regulator tube,  $VT_1$ , is concerned and may be substituted for it at the points X and Y. An increase of output voltage increases the voltage on the grid of  $VT_2$ , thereby increasing its plate current. This current is drawn from the output voltage terminal through the half-megohm resistor between grid and cathode of  $VT_2$ , increasing the voltage drop across it and proportionately dropping the grid voltage of  $VT_1$ . This reduces current through that tube and increases the voltage drop across it, effectively reducing the output voltage.  $VT_2$  is an electronically variable resistor.

A neon-tube, N, or a battery may be used to maintain the cathode voltage at a predetermined level above ground. The half-megohm resistor between it and the rectifier output causes the tube to remain "struck" at all times, thus avoiding oscillator action sometimes experienced otherwise.

Instead of connecting the control-tube grid to a fixed point on the resistor network as in Fig. 6, a potentiometer is in-

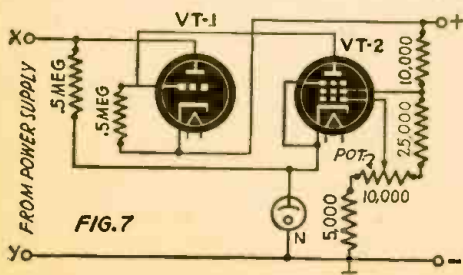

FIG. 7

# RADIO PARTS

## AVAILABLE NOW!

If you are a radio repairman you can buy radio parts with Priority AA-3-V3 according to CMP Regulation 9-A. Schools, institutions and individual accounts—see us first for your electronic needs. Experimenters write to Leo, W9GFQ, for complete information on how to buy hard-to-get radio repair parts.

**SEND FOR OUR LATEST FLYER TODAY!**

Our new flyer is full of merchandise you've been trying to get. Stocks won't last forever. Write today. Forty pages of hard-to-get parts not available elsewhere. Chockful of items such as meters, multi-testers, mikes, pickups, speakers, wire, etc. All in stock for immediate delivery to the radio repair men.



### QUICK SERVICE

Yessir! quick service from the heart of the nation. We're all set to give you that "same day's service"—we've remodeled our store, doubled our shelf space and increased our stock many times. We want you to know that we are doing everything possible to bring you the best in radio parts and equipment.

We have made available thousands of items to thousands of new customers in spite of existing shortages. REMEMBER! all merchandise in our latest flyer is available to you repair men. If you are new in the business, send us your order. Enjoy our quick personal service.



Sincerely,  
Leo S. Thompson

## WHOLESALE RADIO LABORATORIES

744 WEST BROADWAY  
COUNCIL BLUFFS, IA.



### Tube and Circuit Reference Book

Here's a handy reference book that meets the demand for simple, easy to understand data on substitution of radio tubes. Contains valuable technical information on tubes and circuits. It's a guide you'll refer to

time and again. Send for your copy today! Only 10c postpaid.

**Tube-Base Calculator**  
Only 25c



Here's just the calculator you've been looking for! Tells you quickly, tube characteristics that enable you to substitute available tubes for those hard to get. Only 25c. We pay shipping expense.

### Radio Reference Map—15c



Time zones, amateur zones, short wave stations. Other valuable information. Printed in colors; size 3 1/2 x 4 1/2 ft. It's yours! Send 15c to help with packing and mailing.

### WE SPECIALIZE IN HALLICRAFTERS

Service men all over the world are learning that the name "Hallcrafters" stands for quality in radio equipment. For many years we have been one of the country's largest distributors of Hallcrafters—"the radio man's radio." We have Hallcrafters available for immediate delivery on priority. For full particulars, write us today.

Mail Coupon TODAY!

Wholesale Radio Laboratories **RC-5**  
744 West Broadway  
Council Bluffs, Iowa.

- Send your reference book "Tubes and Circuits." Here's my 10c.
- You bet I want a Tube-Base Calculator. 25c is enclosed.
- Ship me your radio map. 15c is enclosed for packaging and mailing.
- Send your free flyer of hard-to-get radio parts.

Name \_\_\_\_\_

Address \_\_\_\_\_

Town \_\_\_\_\_ State \_\_\_\_\_

I am  an amateur;  experimenter;  service man.

serted and the grid attached to its movable arm. Thus the output voltage may be adjusted within certain limits.

This type of voltage regulator has been widely used by experimenters. For voltages in the order required for receiver-type apparatus, the constants shown in the figure are correct.  $VT_1$  may be one or two 2A3's or other heavy-current low-resistance triodes, and  $VT_2$ , a 6J7 or equivalent. The neon tube N is usually of the small 1-watt or 2-watt type, the kind with no built-in resistor. A voltage of approximately 60 is maintained across it.

Necessity for special voltage regulation systems is confined to circuits or devices in which voltage must be kept within very narrow limits. For most work, careful attention to keeping the source resistance low, by using large transformers, filter chokes and condensers, as described in the earlier part of this article, will be sufficient.

**YOUR NEW FREE CATALOG IS READY FOR YOU!**

Radionic's Catalog No. 26 lists hard-to-get radio parts • Helps you fill your radio and electronic needs. • All parts are available for immediate shipment • All are highest quality. • All are exceptional values.

SEND TODAY FOR YOUR FREE COPY TO Dept. 5E

**RADIONIC EQUIPMENT CO.,**  
"CHANCELLOR" PRODUCTS  
170 NASSAU STREET, NEW YORK 7, N. Y.

Photocells now protect the housewife's preserves, inspecting glass jars and bottles for cracks which might spoil the contents.

# One Central Source FOR Everything in RADIO and ELECTRONICS



**LARGEST STOCKS**  
**COMPLETE SERVICE**

**REPAIR and REPLACEMENT PARTS AVAILABLE without priority**

Centralized here are today's largest and most complete stocks under one roof. Over 10,000 items from all leading manufacturers . . . for the Armed Forces, Radio Training, Laboratories, Industry, Service Replacements. Our experienced staff simplifies procurement—expedites delivery.



**R. F. Resonance and Coil Winding CALCULATOR**  
No. 37-955  
Postpaid ..... **25c**



**6 Radio Books for 75c**

Dictionary of Radio Terms. No. 37-751	10c	Radio Data Handbook. No. 37-754	25c
Radio Circuit Handbook. No. 37-753	10c	Radio Builders Handbook. No. 37-750	10c
Radio Formulas & Data Book. No. 37-752	10c	Simplified Radio Servicing. No. 37-755	10c
All Six Books No. 37-799 ..... <b>75c</b>			

*Write for Quantity Prices*

ALLIED RADIO CORP., Dept. 2-E-5  
833 W. Jackson Blvd., Chicago 7, Ill.

Please send following books (...c enclosed)

<input type="checkbox"/> FREE Guide	<input type="checkbox"/> 37-750	<input type="checkbox"/> 37-752	<input type="checkbox"/> 37-754
<input type="checkbox"/> Calculator	<input type="checkbox"/> No. 37-751	<input type="checkbox"/> 37-753	<input type="checkbox"/> 37-755
<input type="checkbox"/> No. 37-799 (All 6 Books)			

Name.....  
Address.....  
City..... State.....

**ALLIED RADIO**

## Better Signal Generator

By L. LANE\*

THE competition for signal generators constructed by readers (in the October, 1944, issue) interested me greatly. I may offer one comment re the winning entry. It might be overlooked that although a transformer is used, it is necessary to take the usual A.C.-D.C. precautions, that the screened box must be isolated and that if half the transformer primary should become shorted a high filament voltage will be impressed.

For five years I have been employed in a radio factory doing war work, putting in nearly 60 hours a week plus one night of 12 hours on fireguard duties, which time I have utilized to build several instruments, one of which was a signal generator. Design was governed by components I had from before the war or what I could construct myself.

First I rewound an old small power transformer for a secondary 120-120 volts center-tapped and a 6-volt, 2-amp. winding for a 6X5 rectifier and 32 mfd. condenser. Main input chokes were universal wound on 1-inch forms and condensers were all mounted in small steel box.

R.F. coils were calculated and checked on a Q bridge using Litz wire, except for the two high-frequency coils dried and impregnated with coil dope. With the aid of the oscillator now built on a small chassis and mounting a small tuning condenser and electronic voltmeter, I now wound the feedback windings. To keep good wave form I aimed for 30 volt output from grid coil. I found that a series condenser helped maintain oscillations on the higher frequencies. I now had complete coverage from 90 Kc. to 30 Mc.

Constructors not fortunate enough to have access to coil-measuring equipment may use windings from I.F. transformers, broadcast and short-wave coils which may be available to them or may wind their own. The following approximate data may be useful as a guide:

Range	Turns	Diameter	Length
9-30 Mc.	3	1/2"	1"
3-9 Mc.	12	1/2"	1"
1-3 Mc.	60	1"	2"

The above calculations were based on the .0005 condenser and ranges will be slightly different with an American .00035 variable. For the broadcast and intermediate frequencies, plenty of universal-wound coils are available from old receivers, and will be practically pre-calibrated. Plate coils should have approximately one-quarter the number of turns given above, though this number may be exceeded for the high frequencies.

For audio oscillator I used a small inter-stage 1-3 transformer parallel-fed to triode section of 6K8. Checking with an oscilloscope, almost perfect wave form was found at 400 cycles with depth of 30%. The attenuator was governed by values on hand and works quite well.

The whole instrument was built in three decks, allowing coils and attenuator to be triple shielded, and the rest double. All hot wires were also shielded, complete dimensions being 12 inches high, 7 wide and 5 deep.

The large 180° plastic dial had a 3-1 reduction drive, pointer being a piece of scrap plastic with hair line. Calibration was accomplished by beating with a standard signal generator and all-wave receiver, also with a 100-Kc. crystal oscillator locked in with a 50-Kc. oscillator which I built. I had to borrow the crystal, as they are not obtainable except for industrial use. Graphs presented no difficulty since the calibration follows a gentle curve except at extreme minimum. I have now had the dial engraved directly in frequencies.

Your October issue was the first one I had seen in years, although I had been a regular reader in former times, and it seems better than ever. We have nothing like it in this country. I am an ex-New York radio serviceman.

\*London, England.

Five bands are covered by Mr. Lane's generator. A constructor satisfied with less range could make one with fewer coils. The excellent attenuator is worthy of special note. Feedback is prevented by the transformer and the two choke coils.

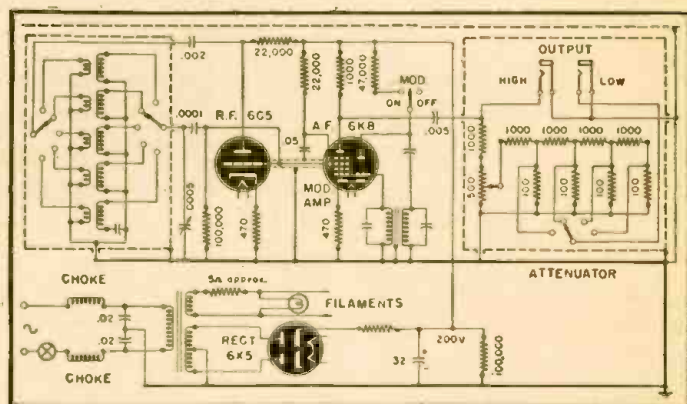

### AUDIO AND VIDEO ON ONE CARRIER

The first broadcast application of the principle of sending sight and sound signals on the same carrier frequency will be incorporated in a new television transmitter to be produced by the Federal Telephone and Radio Corporation of the Columbia Broadcasting System. The transmitter will permit a high degree of definition or sharpness in black and white and in full color,

a quality which will set the standard for broad-band, fine screen television of the highest quality.

The carrier frequency will lie between 450 and 500 mc. and the video frequency band will be 10 mc. The transmitter will be installed on the Chrysler Tower in New York City, and will broadcast programs originating in the studios of WCBW.

## SPEECH AMPLIFIERS

(Continued from page 491)

back voltage is limited by the value of  $R_1$ . By inserting a tuned network in the feedback line we will have a high impedance at all frequencies removed from resonance. This causes the non-resonant frequencies to appear as a voltage drop across the impedance and  $R_2$  in parallel. This voltage is in opposition to the signal voltage and the gain is reduced. At the resonant frequency, the impedance is low and the voltage is by-passed to ground. There is no degenerative action, therefore the gain is boosted at the resonant frequency.

Figs. 5 and 6 are applications of the fundamental circuit. The former named circuit functions in the same manner as discussed for Fig. 4. Fig. 5 is somewhat similar in its operation. In this case the tuned circuits are placed in the grid lead of one of the amplifier stages. All frequencies which are removed from the resonant frequency will have their amplification reduced through the medium of inverse feedback. At the resonant frequency of the tuned networks, the impedance will become very low and the voltage fed back at these frequencies will be by-passed to ground without any appreciable voltage drop which would tend to neutralize the input signal voltage.

When attempting to apply these circuits to present-day equipment, it may be somewhat difficult to obtain the correct value of inductance called for by the diagram or from calculations. If this happens to be the case, it is well to remember that old audio transformers, high resistance speaker fields and small A.C.-D.C. chokes will often do excellent jobs.

It is somewhat difficult to even estimate the inductance of a coil or choke without employing laboratory equipment which is unavailable to the average experimenter but in these circuits, the cut-and-try method will give excellent result if the builder has a little patience. After using one of these tone-control circuits in the speech amplifier section of your amplifier or radio, you will begin to wonder how any one is able to appreciate the beauty of recorded music without some means of balancing the response curve to suit the listening taste of the audience. Many headaches and hours spent computing reactances, resonant frequencies and other values may be saved if the builder has available one of the Reactance Slide Rules which may be obtained from your local radio supply dealer or from one of the leading manufacturers of microphones and pickups.

## NEW TRANSMITTERS SOON

Transmitters may become available as a result of the war's end in Europe. A substantial number, ranging from 1 Kw. to 50 Kw. in power may be on the market for the present or prospective station owner, according to a report last month by John Creutz of the Radio and Radar Division, WPB. Most of the equipment will be sold as surplus property but some of it, including high-power transmitters still in the process of manufacture, will be completed to fill long-standing non-military orders. The bulk of broadcast equipment in use by the military is unsuitable for commercial broadcast operations, although a considerable part of it may be utilized for federal, state and local government needs.

# TOUGH!

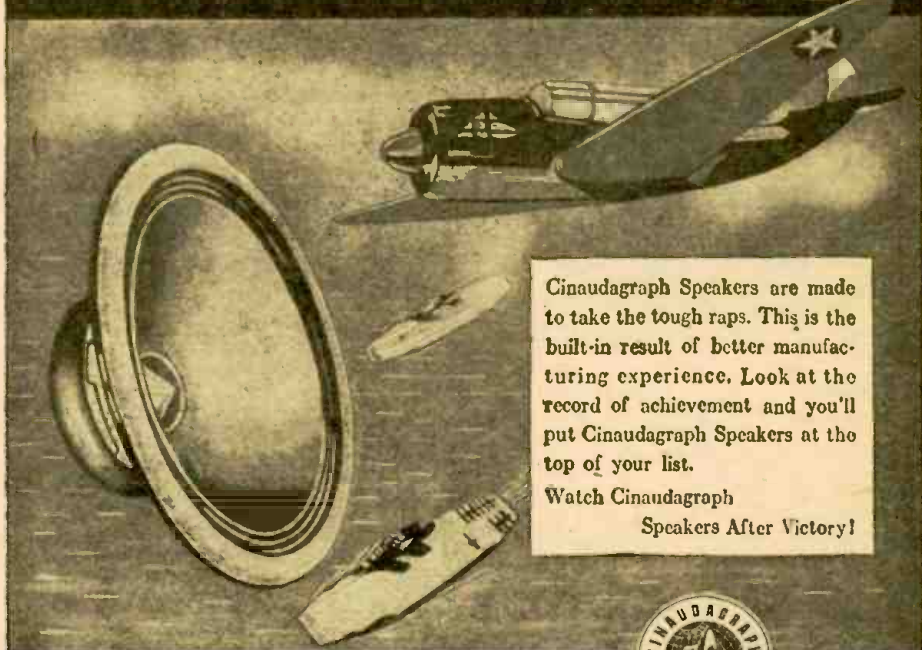

Cinaudagraph Speakers are made to take the tough raps. This is the built-in result of better manufacturing experience. Look at the record of achievement and you'll put Cinaudagraph Speakers at the top of your list.

Watch Cinaudagraph Speakers After Victory!



## Cinaudagraph Speakers, Inc.

3911 S. Michigan Ave., Chicago  
Export Div., 13 E. 40th St., New York 16, N. Y.

"No Finer Speaker in all the World"

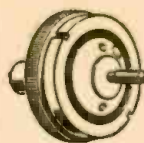

## "WONDER" ELECTRIC BUTTON

Most interesting electrical apparatus ever discovered. Make your own Telephone-Amplifier rooms. Transmit your voice or music to distant rooms. Perform hundreds of fascinating experiments. So tiny it can be concealed in dozens of places. Send \$1 now for button and free 8,000 word instruction booklet with 50 illustrated experiments. SPECIAL OFFER: 6 buttons and booklets sent postpaid for \$5. Write now to

BUCK MFG. COMPANY North Aurora, Illinois

## RECORDING MACHINE REPAIR SERVICE

We are specialists in sales and service of AMPLIFIERS, RECORDING MACHINES, PLAYBACKS and RECORD CHANGERS. Also design and build equipment to your specifications. Wire—Phone—Write your problem.

### STUDIO SERVICE CO.

Division of LERRIS INDUSTRIES  
242 West 49th St. New York 19, N. Y.

## BUILD YOUR OWN MULTI-TESTER

### COMPLETE KIT OF PARTS \$14.95

Matched variable condensers and coils for T.R.F. or Superheterodyne. \$1.50 per set. Dual 20 Mfd.-150 volt condensers, 35c each.

### RADIO KITS COMPANY

120 Cedar Street New York, N. Y.

### Radio Servicemen:

#### RADIO PARTS — TUBES

BARGAIN PRICES—NO PRIORITIES	
KING P.M. SPEAKERS, 4 or 5 inch.	\$1.19
KING 450 OHM SPEAKERS, 4 or 5 inch.	1.49
FILTER COND., 20-20 mfd. 150 V.	.39
BY PASS COND., .01, .02, .05, 1, 600 V.	.07
VOL. CONT., .5 Meg., W. SW., Tap, 3" Shaft.	.55
A.C. CORD AND PLUG SET, 6 Ft.	.29
RESISTOR KIT—50 Ass'd, 1/3 to 1 Watt.	.59

Write Today for Bargain Bulletin  
RADIO DISTRIBUTING CO., Pasadena 18, Calif.

## OPPORTUNITY AD-LETS

Advertisements in this section cost 20 cents a word for each insertion. Name, address and initials must be included at the above rate. Cash should accompany all classified advertisements unless placed by an accredited advertising agency. No advertisement for less than ten words accepted. Ten percent discount six issues, twenty percent for twelve issues. Objectionable or misleading advertisements not accepted. Advertisements for June, 1945, issue must reach us not later than April 28, 1945.

Radio-Craft • 25 W. B'way • New York 7, N. Y.

**BUILD RADIO. COMPLETE KIT WITH TUBES.** \$10.95, details. Radio, 9418b Avenue "A", Brooklyn, N. Y.

**USED CORRESPONDENCE COURSES AND TECHNICAL BOOKS** Bought, Sold, Rented, Exchanged. All subjects. Satisfaction guaranteed. Cash paid for used courses. Complete information and 92-page illustrated bargain catalog free. Write—NELSON COMPANY, Dept. 2-39, Chicago 4.

**CORRESPONDENCE COURSES AND SELF-INSTRUCTION** books, slightly used. Sold, Rented, Exchanged. All subjects. Satisfaction guaranteed. Cash paid for used courses. Complete information and 92-page illustrated bargain catalog free. Write—NELSON COMPANY, Dept. 2-39, Chicago 4.

**LARGE AND VARIED STOCK OF PANEL METERS** and multi-range meters. Panel meters 3/2-inch round war-standard. Specify ranges you want and ask for quotation. Many D.C. instruments without priority. Good supply of critical types on priority. HATRY and YOUNG, Hartford, Connecticut.

**MULTITESTER FOR SALE, BRAND NEW \$18.75.** Order Today. Omaha Radio Products Co., 363 Saunders-Kennedy Bldg., Omaha, Neb.

**RADIO TUBES, PARTS, CONDENSERS, FREE BARGAIN** lists. Potter, 1314 McGee, Kansas City, Mo.

**MAGAZINES (BACK DATED)—FOREIGN, DOMESTIC,** arts, books, booklets, subscriptions, pin-ups, etc. Catalog 10c (refund). Ciccone's, 863 First Ave., New York 17, N. Y.

**UNIVERSAL RADIO TOOLS—DANDY 16 PIECE SET:** Midget Pliers, Diagonal Cutters, Four Midget End Wrenches, Needlenose Pliers, Screw Holder, Six Punches and Chisel, Round File, Midget Crescent Wrench, \$14.85. Remit with order. Immediate Shipment. Overright by Air to Anywhere. U.S.A. Universal Tool Company, 1527 Grand RC, Kansas City, Mo.

**I HAVE A FEW AC METERS, WATT METERS, MILLI-** amp Meters, Relays. Details. Radio, 307 Baynes St., Buffalo 13, N. Y.

**HARDWARE AND RADIO KIT—CONTAINS 1000** items for repairing and experimenting—bolts, screws, nuts, speed nuts, washers, rivets, spacers, springs, studs, eyelets, cotter pins, lugs, brackets, angles, etc., pieces bakelite, fiber, formica, mica, mycalex, rubber, bimetal. Also coils, sockets, condensers, resistors, rheostats, etc. \$2.00 per kit. Sent C.O.D. RADIOCO, 1110 R Marshall Bldg., Cleveland, O.

# DEALERS

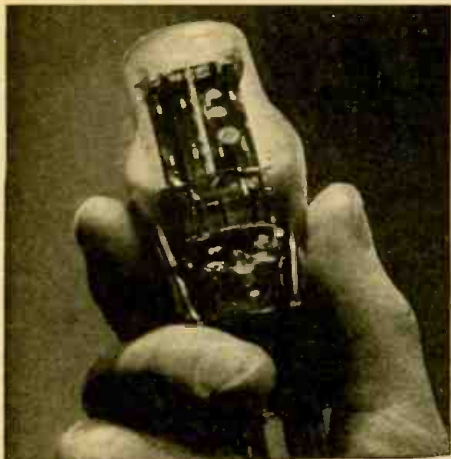

**STOP!**  
don't  
throw it away!

Let **RTS** reprocess  
your dead

## RADIO TUBES

*NEW Scientific Process*

**REACTIVATES THORIUM  
CONNECTS OPEN FILAMENTS  
CLEARS SHORTS and  
MICROPHONICS**

(NOT the old "flash" trick)

MINIMUM ORDER 6 TUBES

**SEND NO CASH**

**C. O. D. ONLY**

**30-Day Guarantee**

Every tube fully tested in checkers & sets before playing

50¢

EA.

Prices approved by O.P.A.  
1 volt & 3-Q5 \$1.00

Send itemized list with order

Make sure glass, base & prongs are intact... flashed, exploded or open cathodes **REJECTED** and **NOT RETURNED**

**RTS RADIO TUBE SERVICE CO. INC.**

6805 20th Avenue, Brooklyn 4, N.Y.

## RADAR PRINCIPLES (Continued from page 484)

arrangement was used in the well-known "squegging" condition to produce trains of oscillations or pulses of a duration of about 100 microseconds, spaced in time 0.02 second apart; i.e., at a recurrence frequency of 50 per second. This type of oscillator had been used previously to give a linear time base for cathode-ray oscillographic delineation of wave-form by E. V. Appleton, R. A. Watson Watt, and J. F. Herd, and its application to ionospheric recording had been suggested by Appleton in 1928.

Since the time of transit of the waves to the E region of the ionosphere and back again is of the order of 0.002 second, it is clear that using pulses of the type just described, first the ground-wave pulse will be all over before the arrival of the first echo, and secondly, that there is ample interval between successive ground-wave pulses to receive and record one or more echoes. For visually observing, and subsequently photographing, the nature of the received signals, a cathode-ray oscillograph was used, with a time-base provided from a similar basic circuit using a squegging oscillator, the stroke-frequency of the time-base being synchronized with the pulse recurrence frequency of the sender, so that a stationary image on the oscillograph screen was produced showing the ground wave and any echo waves received.

The type of result obtained is shown in Fig. 8 (a), (b) and (c) which are reproduced from the paper referred to above, and are specimens of the actual records obtained by Appleton and Builder in 1931. Fig. 8 (a) shows the ground-wave pulses received without echoes, while Fig. 8 (b) shows the presence of a single echo signal after reflection from the F<sub>1</sub> layer. In this case the time interval can be measured in terms of the trace of an alternating current of frequency 1115 cycles per second shown below the signal record. Fig. 8 (c) is a snap photograph of the echo pattern on the cathode-ray tube, showing the ground wave G and the F region echo delineated on a time-base, which in this case corresponds to a period of about 12 milliseconds. This was probably the first published picture of what is seen on the screen of the cathode-ray tube of a sending and receiving system used for determining range by measuring the time delay of the echo signal relative to that of the ground or direct path signal.

### A WAVE TRANSFORMER



Suggested by:  
Albert A. Mueller, Sioux Falls, S. D.

The pulse-generating oscillator, and the cathode-ray tube and linear time-base combination so described by Appleton and Builder in 1931, formed the basis of the technique used some four years later in the first Radar experiments on aircraft detection conducted in this country.

### AIRCRAFT HEIGHT INDICATORS

While scientific research on methods of exploring the ionosphere was being conducted on the lines described above, a corresponding technique was being developed concurrently and on very similar lines for the purpose of producing an instrument for indicating the height of an aircraft in flight above the ground. For example, in 1928 J. O. Bentley described a method in which frequency-modulated waves are radiated towards the earth from a transmitter on the aircraft. A receiver, also on the aircraft, receives the waves after reflection from the ground and combines them with those received direct from the transmitter, the latter waves differing slightly in frequency due to the time of travel of the waves to the ground and back again. The frequency of the beats in the receiver resulting from the two sets of waves is thus a measure of the height of the aircraft above the ground beneath, as distinct from its altitude above sea-level, which is what is indicated by the type of altimeter dependent upon barometric pressure.

This instrumental technique was later improved by L. Espenschied in 1930, and culminated in a commercial pattern of "terrain clearance indicator" produced by the Bell Telephone Laboratories in 1938. The apparent delay in the successful production of this instrument was due to the fact that the heights in question are much smaller than those involved in ionospheric research, and that therefore the echo-time intervals to be measured are correspondingly less; e.g., 10 microseconds for about 5,000 ft. An illustrated description of this method of echo sounding for aircraft was given in *Radio-Craft* for January, 1939.

The pulse modulation method of altitude determination in aircraft is clearly applicable, provided that the pulse lengths are reduced sufficiently to discriminate the echoes arriving at a much shorter time delay than is the case of the ionospheric work. Such a system was, in fact, described by the Submarine Signal Company in June, 1933. Here the scheme proposed for measuring distances used pulses of electric waves, in association with a means of receiving the reflected echoes, and determining the time interval between the emitted and received pulses with the aid of a cathode-ray tube and synchronized time-base.

In December, 1931, the British Post Office observed the effects of reflection of waves from aircraft in the course of some radio communication tests being conducted on a wave length of 5 metres over a path 12 miles long. Extracts from the station log show that on various occasions the received signal was subject to a beat type of variation, which was not only audible but was detectable on the volume indicator of the receiver. The amplitude of the beat varied from about  $\pm \frac{1}{2}$  db. up to 10 db. on some occasions, and at all times when this occurred an aircraft was found to be flying in the neighborhood at various distances up to  $2\frac{1}{2}$  miles and at heights up to 500 feet. The period of the beats varied from 5 to 15 per second; and this is to be

compared with the calculated value of 11 per second for an aircraft flying directly towards the receiving aerial at a speed of 60 m.p.h.

This experience was confirmed by further observations made in America in 1932 by engineers of the Bell Telephone Laboratories in the course of an investigation of the mode of propagation of radio waves in the range of wave lengths between 4.7 and 5.7 metres. In a paper describing this work by Messrs. C. R. Englund, A. B. Crawford and W. W. Mumford, and published in March, 1933, it is stated that an aircraft flying about 1,500 ft. overhead and approximately along the line joining transmitter and receiver, a noticeable flutter of about four cycles per second was produced in the low-frequency detector meter of the receiver. When observations were carried out in the neighborhood of an airport, it was noticed that near-by aircraft produced field strength variations up to 2 db. in amplitude. Similar reradiation was noticed at various subsequent times, occasionally when the aircraft was invisible.

It was thus clearly established, over ten years ago, that radio waves reflected from aircraft in flight could be detected with suitable receiving equipment on the ground; and it now remained to be seen whether this principle could be applied to the development of a technique for the detection and location of aircraft at ranges and under conditions of practical utility as an aid to navigation in peacetime and as a defensive weapon in war. This important, and by no means easy, step was accomplished by a small group of scientists working under the direction of Mr. (now Sir Robert) Watson Watt, who was at the time Superintendent of the Radio Department of the National Physical Laboratory, incorporating the Radio Research Station at Slough where the initial experiments in the radio location of artificial objects in this country were conducted.

Watson Watt, in association with the late J. F. Herd, had also devised the original form of visual direction finder, using twin balanced amplifiers and a cathode-ray indicator.

After some preliminary experiments, members of the staff under Watson Watt's supervision established a new "ionospheric" exploring station on the East Coast of England, at which were installed the, for those days, high-power pulse transmitters made at Slough, together with suitable receivers and appropriate aerial systems and goniometers for determining the direction of arrival of the echo waves, both in azimuth and elevation, scattered back to the receiver from the aircraft which was illuminated, as it were, by the flood-lighting effect of the radiation from the transmitter.

The members of that small band of scientists and technical assistants will well remember the thrill of seeing for the first time a clear image on the cathode-ray tube due to an aircraft which was so far away as to be invisible to the naked eye; the distance of the pip along the base line gave the range of the aircraft while its bearing and elevation were obtainable by turning the knobs of the goniometers.

Much hard work and not a little ingenuity were still required to convert the technique from an experiment in the hands of scientists to a working system which could be used and maintained by this miscellaneous type of personnel which was at that time provided by the Service departments for this new "side-line" of radio communication or signalling. It was not long, however, and well before war was declared, before more than one Service station was in operation, and the plotting of the tracks of various aircraft, some on their legitimate civil or military duties, and others whose business was perhaps less innocent, was a matter of daily routine.

#### WORK IN OTHER COUNTRIES

An indication of the trend of thought and activities in other countries in the years before the outbreak of the present war can be gained from a perusal of one or two publications which are available. Reference has already been made to the patent taken out in U.S.A. by H. Löwy; but the main development in America seems to have taken place partly in the Service research institutions, and partly at the Bell Telephone Laboratories. The latter organization, after developing the aircraft altimeter, demonstrated the use of this instrument in a modified form to the detection of ships over short distances. With regard to the Continent, it is to be noted that the Tele-

# ELECTRICITY

● for Radio and Electronic Applications

ONAN ELECTRIC GENERATING PLANTS supply reliable, economical electric service for electronics applications as well as for scores of general uses.

Driven by Onan-built, 4-cycle gasoline engines, these power units are of single-unit, compact design and sturdy construction. Suitable for mobile, stationary or emergency service.

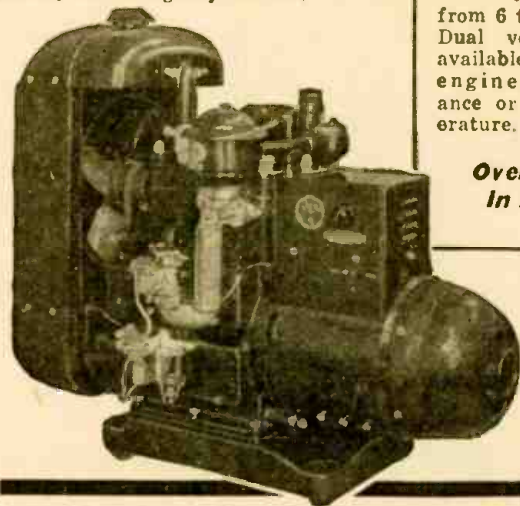

Models range from 350 to 35,000 watts. A.C. types from 115 to 660 volts; 50, 60, 180 cycles, single or three-phase; 400, 500, and 800 cycle, single phase; also special frequencies.

D.C. types range from 6 to 4000 volts. Dual voltage types available. Write for engineering assistance or detailed literature.

Over 250,000  
In service

Model Shown is from W2C series, 2 and 3-KW, 60-cycle, 115 volt; powered by water-cooled, 2-cylinder engine.

**D. W. ONAN & SONS** 2415 Royalston Ave., Minneapolis 5, Minn.

## SPEED UP REPAIRS WITH THESE G-C AIDS!



FREE  
STEEL  
CABINET

### G-C DIAL BELT KITS

Exact replacement woven fabric belts. Easy to install—no stretching—no adjustments—a perfect fit everytime. Kits come with 25, 50, 100, 200 or 300 belts.



### G-C AUTOMATIC WIRE STRIPPER

Strips insulation from all types of wire. Does the job instantly, easily, perfectly. An ideal tool for radio men, electricians and sound men.



### G-C NE-O-LITE

New improved design. Useful hundreds of ways. Tests AC and DC lines, DC polarity, fuses, etc. You can't afford to be without this handy all-purpose trouble shooter.

Order From Your Radio Parts Jobber  
ALWAYS ASK FOR G-C PRODUCTS



**GENERAL CEMENT MFG. CO.**  
ROCKFORD, ILLINOIS

funkun Company filed a patent in 1935, disclosing an arrangement similar to the frequency-change method used by Appleton, with the modification also suggested by Appleton that, while the carrier frequency remained unaltered, the frequency of the modulation was varied, while the number of interference fringes was counted at the receiver. The American journal *Electronics*

published in September, 1935, a two-page set of illustrations descriptive of the aircraft detection arrangements alleged to be under development by the Telefunken Company. An interesting feature of this pictorial display was the reference to the use of wave lengths in the band 5 to 15 cm. and of magnetron valves with permanent mag-

(Continued on following page)

# ALLEN Key Kits

Key Assortments to fit Hex-Socket Screws in the range of sizes the radio mechanic needs for everyday work.

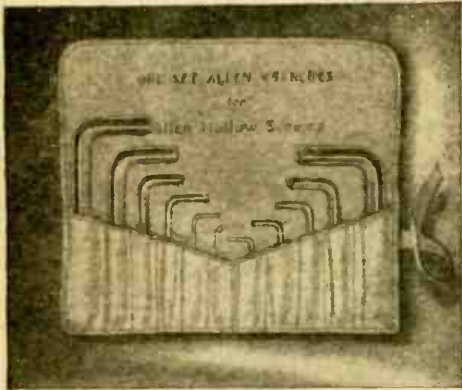

**KEY SET No. 603:** This canvas partitioned bag contains 11 short arm hexagonal keys which fit all screws from and including No. 10 up to and including 1 1/4" diameter set screws. List price \$1.75.

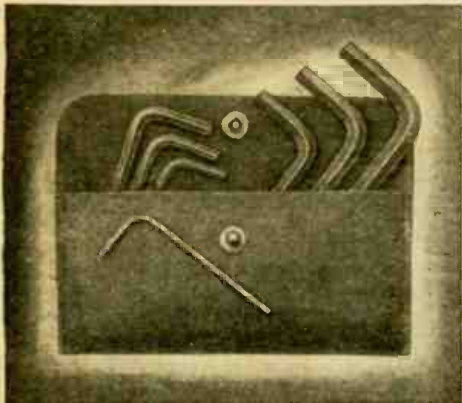

**JUNIOR KEY KIT No. 604:** Seven short-arm Allen Keys are included in this strong leatherette envelope. They fit the hex holes of sizes Nos. 8, 10, 1/4", 5/16", 3/8", 7/16" and 1/2" set screws and Nos. 4, 5, 6, 8, 10, also 1/4" and 5/16" cap screws. List price \$0.50.

## KEY ISLAND

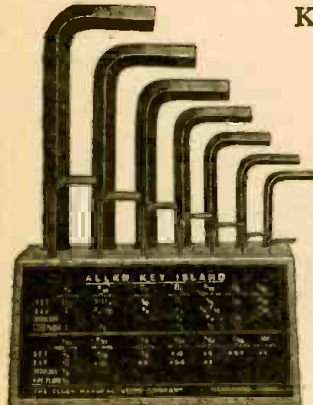

This handy key set contains 14 keys fitting all sizes of set screws up to and including 1 1/4"; cap screws up to 1"; shoulder screws to 1" and pipe plugs to 1". Container is plainly labeled to show the correct size key to use with each screw. No. 615; list price \$2.35.

Ask for complete listings of Allen Hollow Screw Assortments and Key Kits. Address inquiries and orders to Dep't. E.

**THE ALLEN MFG. CO., HARTFORD 1, CONN., U. S. A.**

(Continued from previous page)

nets developed specially for wave lengths of about 10 cm. An alternative scheme was also described by the Telefunken Company in 1937, which utilized two beams of transmitted waves to produce a stationary interference pattern, the disturbance of which by an object moving across it was detected at the receiver.

## FRENCH AND ITALIAN APPARATUS

In Italy, E. Montu described a twin rotating aerial arrangement for locating aircraft in bearing and elevation, and the patent specification of this arrangement was published in this country in December, 1936. About three years later U. Tiberio published the first part of a comprehensive paper, discussing various aspects of the radiolocation of ships and aircraft, in the Italian periodical *Alta Frequenza*; the later parts of the paper were apparently withheld from publication after the outbreak of the war. An interesting development in France was the fitting of the steamship *Normandie* with an iceberg detector, which was described and illustrated in *Wireless World* for June 26, 1936. This equipment comprised a transmitter and receiver operating on a wave length of 16 cm. and mounted in the fore part of the ship. The transmitting and receiving aerials were of the dipole type and mounted in parabolic reflectors, 75 cm. in diameter and installed at a distance of 6 metres apart; this arrangement provided a beam having a width of  $\pm 10$  deg. at half amplitude, and the reflectors could be rotated automatically through an arc of 40 deg. When the receiver indicated the arrival of a signal from the transmitter after reflection from a distant object, the two parts of the equipment could be manually and accurately trained on this object, the distance of which could then be calculated from the directions of the transmitted and arriving waves. In this manner it was claimed that a coastline could be located at a distance of 20 km., and large ships were detected at ranges up to about 7 km.

Such was the state of affairs abroad as judged by the sparse published information available. As to what was the actual state of affairs at the outbreak of the war in Europe must remain a matter of speculation at the present time; but many readers will look forward with interest to the time when more facts may be disclosed, and the progress of the Radar technique conducted by the various belligerent nations may be described and compared.

(The above article was reprinted by special permission of *Wireless World*, London, England.)

## \$3.00 FOR YOUR CARTOON IDEAS

RADIO-CRAFT, as you will have noticed, prints a number of radio cartoons, which we intend to keep on publishing every month indefinitely. We invite our readers to contribute to this feature by sending in their ideas of humorous radio ideas which can be used in cartoon form. It is not necessary that you draw a sketch, but you may do so if you so desire.

RADIO-CRAFT will pay \$3.00 for each original idea submitted and accepted.

We cannot return ideas to this department nor can we enter into correspondence in connection with them. Checks are payable on acceptance.

Address all entries to RADIO CARTOONS, c/o RADIO-CRAFT, 25 West Broadway, New York 7, N. Y.

# FOR SALE HARD-TO-GET ITEMS

All items are brand new, except where indicated. ALL are in PERFECT WORKING ORDER. In many cases, the parts alone total more than the price we are asking. Satisfaction guaranteed or your money back. ORDER FROM THIS PAGE. Use our convenient coupon. Include sufficient extra remittance for parcel post charges, otherwise order is sent express collect. Any excess will be refunded. All C.O.D. shipments require 20% deposit. No C.O.D. shipments on orders for less than \$5.00. If full remittance accompanies order deduct 2% discount. Send money order, certified check, or new U. S. stamps. No C. O. D.'s to foreign countries.

**ULTRA MAGNET**  
LIFTS MORE THAN 20 TIMES ITS OWN WEIGHT  
**LITTLE GIANT MAGNET**  
Lifts 5 lbs. easily. Weighs 4 oz. Made of ALNICO new high-magnetic steel. Complete with keeper. World's most powerful magnet ever made. The experimenter and hobbyist will find hundreds of excellent uses for this high quality permanent magnet. Measures 1 3/4" x 1 1/2" Sh. Wt. 8 1/2 lbs.  
ITEM NO. 159  
YOUR PRICE ..... \$1.50



**GENUINE MICROPHONE TRANSMITTERS**  
These are regular "telephone transmitters" of the type used on wall telephones. Taken from a large telephone supply company's overstock, these fine mike offer a grand opportunity to obtain a splendid unit for little more than the price usually asked for a simple microphone button.  
The amateur experimenter and telephone mechanic will find a variety of uses for these excellent microphones. They work perfectly on 2 dry cells.  
Can be used on P.A. systems for voice transmissions. In call systems and intercommunications sets. With telephone receivers (radio headphones will do) they may be made into short-line telephone circuits. Such as house-to-house or farm-to-farm "phone lines." You can use them to talk through your own radio, or as concealed dictaphone pick-up units for listening to conversations in a distant room or building. The telephone mechanic will find them useful replacements on battery-operated rural telephone lines.  
**THESE ARE GENUINE TRANSMITTERS. MADE BY KELLOGG, WESTERN ELECTRIC AND STROMBERG-CALSON.** Excellent in appearance and operation. A remarkable value, and one seldom offered in these times. Sh. Wt. 1 lb.  
ITEM NO. 160  
YOUR PRICE ..... \$1.50

**AMAZING BLACK LIGHT!!**  
Powerful 250-Watt Ultra-Violet Source  
The best and most practical source of ultra-violet light for general experimental and entertainment use. Makes all fluorescent substances brilliantly luminescent. No transformers of any kind needed. Fits any standard lamp socket. Made with special filter glass permitting only ultra-violet rays to come through. Brings out beautiful opalescent hues in various types of materials. Swell for amateur parties, plays, etc.; to obtain unique lighting effects. Bulb only. Sh. Wt. 2 lbs.  
ITEM NO. 161  
YOUR PRICE ..... \$2.45

**WATT HOUR METER**  
Completely overhauled and ready for immediate service. Designed for regular 110-volt 60 cycle 2-wire A.C. circuit. Servicemen use it in their shops to check current consumption of sets, soldering irons, etc. Keeps costs down. If dismantled, the parts alone would bring the price. The elaborate Rear train could be used as a counter on machines of various kinds. Simple to install: 2 wires from the line and 2 wires to the load. Sturdily constructed in heavy metal case. 8 1/2" high, 6 1/2" wide, 5" deep. Westinghouse, G. E., Ft. Wayne, Sangamo or other available make. Sh. Wt. 14 lbs.  
ITEM NO. 33  
YOUR PRICE ..... \$5.95

**LIMITED QUANTITIES! PROMPT SHIPMENTS!**  
It's Easy to Order—Clip Coupon—Order from This Page—No Catalog Sent.  
**MAIL TODAY—NOW!**  
(See corresponding Ad Page 533)

**HUDSON SPECIALTIES CO.**  
40 West Broadway, Dept. RC-5.45, New York 7, N. Y.

I have circled below the numbers of the items I'm ordering. My full remittance of \$..... (include shipping charges) is enclosed (NO C.O.D. ORDERS UNLESS ACCOMPANIED WITH A DEPOSIT.) OR my deposit of \$..... is enclosed (20% required), and order C.O.D. balance. NO C.O.D. ORDER FOR LESS THAN \$5.00. (New U. S. stamps, check or money order accepted.)  
Circle Item No. wanted: 33 87 159 160

Name .....

Address .....

Please Print Clearly

City .....

Send remittance by check, stamps or money order; register letter if you send cash or stamps.

## WORLD-WIDE STATION LIST

(Continued from page 500)

15.140	GSF	LONDON, ENGLAND; Australia, 7:45 to 10 am; Near East, 1:45 am to 1:15 pm; India, 7:45 to 11:15 am.
15.150	WRCA	NEW YORK CITY; Brazilian beam, 5 to 7:45 pm.
15.150	WNBI	NEW YORK CITY; European beam, 9 to 11:30 am; South American beam, 11:45 am to 3:30 pm.
15.150	KNBC	SAN FRANCISCO, CALIFORNIA; East Indies beam, 9:20 to 11:15 pm.
15.155	SBT	STOCKHOLM, SWEDEN; 11 to 11:55 am.
15.160	JZK	TOKYO, JAPAN; heard at 8:30 pm.
15.170	TGWA	GUATEMALA CITY, GUATEMALA; daytime transmissions.
15.180	GSO	LONDON, ENGLAND; Pacific, 6 to 8 am; South America, 12:15 to 3:45 pm; India, 2 to 4 am.
15.190	CBFZ	MONTREAL, CANADA.
15.190	WOOC	NEW YORK CITY; European beam, 6:30 am to 3 pm.
15.190	KROJ	LOS ANGELES, CALIFORNIA; New Guinea beam, 4 to 5:45 pm.
15.200	DJB	BERLIN, GERMANY.
15.200	WLWS1	CINCINNATI, OHIO; South American beam, 8:45 to 10:15 am; 6 to 8:15 pm.
15.200	WLWL2	CINCINNATI, OHIO; South African beam, noon to 2:30 pm.
15.210	KGEX	SAN FRANCISCO, CALIFORNIA; East Indies beam, 7 to 11:15 pm.
15.210	WBOS	BOSTON, MASSACHUSETTS; European beam, 7 am to 3:15 pm.
15.210	—	MOSCOW, U.S.S.R.; 6:45 to 7:25 pm.
15.225	JTL3	TOKYO, JAPAN; 6:15 to 8:15 pm.
15.230	VLG6	MELBOURNE, AUSTRALIA.
15.230	WLWL2	CINCINNATI, OHIO; Central Africa beam, noon to 2:30 pm; North African beam, 2:45 to 4:45 pm.
15.230	—	MOSCOW, U.S.S.R.; 6:45 to 7:25 pm.
15.240	KNBC	SAN FRANCISCO, CALIFORNIA; Oriental beam, 4 to 6:45 pm; 7 to 9:05 pm; East Indies beam, 9:20 to 11:15 pm.
15.250	WLWK	CINCINNATI, OHIO; South American beam, 6 to 8:15 pm.
15.250	WLWO	CINCINNATI, OHIO; European beam, 8:30 am to 3:45 pm.
15.260	GS1	LONDON, ENGLAND; Africa, 11:30 am to 5 pm.
15.270	WCBX	NEW YORK CITY; European beam, 6:30 am to 4:45 pm.
15.270	KCBA	LOS ANGELES, CALIFORNIA; South American beam, 5 to 8:20 pm.
15.280	DJQ	BERLIN, GERMANY; Eastern service, 6 am to noon.
15.290	KWIX	SAN FRANCISCO, CALIFORNIA; Oriental beam, 8 to 11 pm.
15.300	—	MANILA, PHILIPPINES.
15.300	GWR	LONDON, ENGLAND; South America, 6 to 7:15 am.
15.310	GSP	LONDON, ENGLAND; North America, 7:15 am to 5 pm; Africa, 2 to 4 am.
15.315	VLC4	MELBOURNE, AUSTRALIA; North American beam, 9:45 to 11 pm.
15.315	VLQ3	SYDNEY, AUSTRALIA; 12:45 to 1:45 am.
15.325	JLP2	TOKYO, JAPAN; 11:30 pm to 12:30 am.
15.330	WGEO	SCHENECTADY, NEW YORK; European beam, 6:30 to 9:30 am; 9:45 to 11 am; 11:15 am to 12:30 pm; 12:45 to 3:45 pm.
15.330	MTCY	HSINGKING, MANCHUKUO; last heard at 1 to 3 am; Japanese controlled.
15.340	—	BERLIN, GERMANY; mornings.
15.340	KNBI	SAN FRANCISCO, CALIFORNIA; South American beam, 11 am to 6:30 pm; 7 to 9:30 pm.
15.350	WRUW	BOSTON, MASSACHUSETTS; Caribbean beam, 6:15 to 7:15 pm.
15.350	WRUA	BOSTON, MASSACHUSETTS; European beam, 6:30 am to 5 pm.
15.360	—	SINGAPORE, STRAITS SETTLEMENTS; "Radio Shonan."
15.375	GRE	LONDON, ENGLAND.
15.420	GWD	LONDON, ENGLAND; Pacific, 4:45 to 6 am.
15.430	—	MANILA, PHILIPPINES; used call CIBN under Japanese at 8 pm; not heard since recapture by Americans.
15.435	GWE	LONDON, ENGLAND; Middle East, 1 to 4 am; 5 to 11:15 am.
15.450	GRD	LONDON, ENGLAND; Africa, 11:30 am to 2:15 pm.
15.460	KKR	LOCATION UNKNOWN; heard point-to-point with New York.
15.505	CMA5	HAVANA, CUBA; 7:45 to 8:30 pm.
15.595	FZ1	BRAZZAVILLE, FRENCH WEST AFRICA; 11:45 am to 12:55 pm.
15.620	VRR6	JAMAICA, BRITISH WEST INDIES.
15.750	—	MOSCOW, U.S.S.R.; 6:45 to 7:25 pm.
15.810	LSL3	BUENOS AIRES, ARGENTINA; heard mornings.
15.820	—	PARIS, FRANCE; "Station Parée"; call CBS and NBC for press reports and relay broadcasts from European war theatre.
17.445	HVJ	VATICAN CITY; heard at 11 am.
17.700	GVP	LONDON, ENGLAND.
17.715	GRA	LONDON, ENGLAND.
17.730	GVQ	LONDON, ENGLAND; Near East, 7:30 to 11:15 am.
17.750	WRUW	BOSTON, MASSACHUSETTS; Central American beam, 8:30 to 10:15 am; 7:30 to 9:15 pm; European beam, 10:30 am to 1:15 pm.
17.760	KWID	SAN FRANCISCO, CALIFORNIA; South American beam, 4 to 7:30 pm.
17.760	KWIX	SAN FRANCISCO, CALIFORNIA; South American beam, 10 am to 4 pm.
17.760	KROJ	LOS ANGELES, CALIFORNIA; New Guinea beam, 9 to 11:45 pm.
17.780	WNBI	NEW YORK CITY; South American beam, 6 to 7:15 pm.
17.780	WRCA	NEW YORK CITY; European beam, 7:30 am to 1 pm.
17.790	GSG	LONDON, ENGLAND.
17.800	WLWO	CINCINNATI, OHIO; South American beam, 6 to 6:45 pm.



## THERMOSTATIC METAL TYPE DELAY RELAYS

PROVIDE DELAYS RANGING FROM 1 TO 120 SECONDS

Other important features include:—

1. Compensated for ambient temperature changes from  $-40^{\circ}$  to  $110^{\circ}$ F.
2. Contact ratings up to 115V-10a AC.
3. Hermetically sealed — not affected by altitude, moisture or other climate changes... Explosion-proof.
4. Octal radio base for easy replacement.
5. Compact, light, rugged, inexpensive.
6. Circuits available: SPST Normally Open; SPST Normally Closed.

WHAT'S YOUR PROBLEM? Send for "Special Problem Sheet" and Descriptive Bulletin.

**AMPERITE CO.** 561 BROADWAY  
NEW YORK 12, N. Y.

In Canada: Atlas Radio Corp., Ltd.  
560 King St. W., Toronto

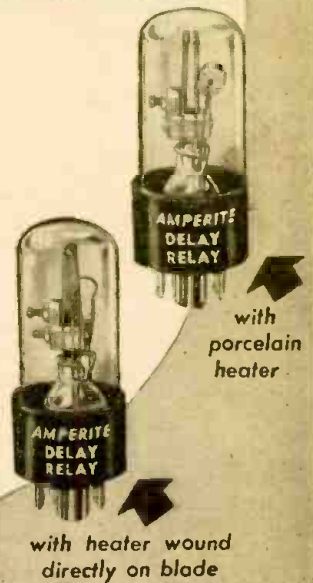

17.800	KRHO	HONOLULU, HAWAII; Chinese-Japanese beam, 7 pm to 2:45 am.
17.810	GSV	LONDON, ENGLAND; Australia, 6 to 10 am; Africa, 5 to 11:15 am; India, 3 to 10 am.
17.820	APH	ALLIED HEADQUARTERS IN ITALY; heard mornings with press reports for New York.
17.830	WCBN	NEW YORK CITY; European beam, 6:30 am to 1:15 pm.
17.830	KROX	SAN FRANCISCO, CALIFORNIA; Hawaiian beam, 5 to 6:45 pm; Philippine beam, 7 to 11 pm.
17.850	DJH	BERLIN, GERMANY; South American beam, 7:15 to 10:30 am.
17.870	GRP	LONDON, ENGLAND; Africa, 11:30 am to 1 pm.
17.880	WGEX	SCHENECTADY, NEW YORK; European beam, 9:15 am to 1:15 pm.
17.955	WLWL1	CINCINNATI, OHIO; North African beam, 6:30 to 8:15 am; South African beam, 10 to 11:45 am; noon to 2:30 pm; European beam, 9 to 9:45 am.
18.025	GRO	LONDON, ENGLAND.
18.080	GVO	LONDON, ENGLAND; South America, 7 to 8 am; 10 to 11:15 am; 12:45 to 1:45 pm.
18.135	YDA	BATAVIA, JAVA (NETHERLANDS EAST INDIES).
18.160	WNRA	NEW YORK CITY; European beam, 9:30 am to 2 pm.
18.180	WLWS2	CINCINNATI, OHIO; South American beam, 8:45 to 10:15 am; 11:45 am to 3:30 pm.
21.470	GSA	LONDON, ENGLAND; Africa, 7:45 to 11 am.
21.530	GSJ	LONDON, ENGLAND.
21.550	GST	LONDON, ENGLAND.
21.610	KNBX	SAN FRANCISCO, CALIFORNIA; South American beam, 11 am to 6:30 pm.
21.640	GRZ	LONDON, ENGLAND.
21.675	GYR	LONDON, ENGLAND; India, 5 to 7:30 pm.
21.710	GVS	LONDON, ENGLAND.
21.750	GVT	LONDON, ENGLAND.
25.750	GSQ	LONDON, ENGLAND.
26.100	GSK	LONDON, ENGLAND.
26.400	GSR	LONDON, ENGLAND.
26.550	GSS	LONDON, ENGLAND.

## Hard to get Radio Parts

### 600 VOLT CONDENSERS

(Sprague - Solar - Aerovox)

.00025 Mfd.	12	100	Mfd.	25	V.	.51
.001	12	10	"	50	V.	.33
.002	12	20	"	150	V.	.45
.005	12	20-20	"	150	V.	.78
.01	12	50	"	150	V.	.66
.02	12	20	"	250	V.	.60
.05	15	10	"	450	V.	.51
.1	18	10-10	"	450	V.	.84
.25	27	40	"	450	V.	1.05

## 1600 Volt Buffers - Solar

.01	27	.05	33	.005	27
.02	27	.007	27		

Philmore Headphones Double (2000 Ohms Imp.) 1.95  
1-watt Stackpole Resistors, 10 Ohms to 30 Megs. .12  
Wire wound Vol. Controls, 2 Ohms to 10M .60  
OZ Tubes (Limit 6 Ea.) .90

All orders must be accompanied with L-265 Certification.

## BAKERSFIELD RADIO SUPPLY

Division of Poston Radio  
2808 CHESTER AVE.  
BAKERSFIELD, CALIF.

## PATENTS—TRADE MARKS

Booklet concerning Inventions & Patents Form "Evidence of Conception" with instructions for use and "Schedule of Government and Attorneys Fees"—Free  
LANCASTER, ALLWINE & ROMMEL  
Registered Patent Attorneys

436 Bowen Bldg.

Washington 5, D. C.

## Attention Radio Servicemen

Many hard to get items.  
Send post card for new price list.

JOHN A. COX  
WHOLESALE RADIO SUPPLIES

557-7th Street.

Parkersburg, W. Va.

A magnetic method of separating pure iron particles from those containing carbon has been patented by Prof. John Wulff of Harvard.

Iron containing carbon becomes much less magnetic at a certain critical temperature than pure iron. Iron powder is therefore flowed over a magnetic separator, the pure iron sticking and the other falling off.

**IMMEDIATE DELIVERY**

# RADIO PARTS

**AND SOUND EQUIPMENT**

Hookup wire—short lengths—  
69c pound

Hookup and Push-back wire—assorted colors—rubber, cotton and plastic cover—89c per 100'—10 assorted 100' rolls .....\$7.80

20 Mfd 150 V Tubular condensers 37c  
20-20 Mfd 150 V Tubular condensers .....60c

20-30 Mfd 150 V Tubular condensers .....69c

4" ElectroDynamic Spkrs. 450 ohm .....\$1.68

5" ElectroDynamic Spkrs. 450 ohm .....1.86

6" ElectroDynamic Spkrs. 450 ohm .....2.58

5" 6 Volt Auto Speakers .....1.68

7" 6 Volt Auto Speakers .....1.59

8" 6 Volt Auto Speakers .....1.59

6x9" 6 Volt Oval Auto Speakers 1.59

10 Watt Wire Wound Resistors, all values .....24c

Write for latest bulletin listing hundreds of items available for immediate shipment.

**LIFETIME SOUND EQUIPMENT CO.**  
P.O. BOX 83 • TOLEDO 1 OHIO, U.S.A.

**OLSON presents**

**THRIFTY CORD RACK**

YOU SAVE OVER A DOLLAR ON 300 FT. OF CORD, AND YOU GET THE HANDY CORD-HOLDER FREE

**\$4.87** PLUS POSTAGE

Includes 100 ft. of pre-stretched Special Thin Cord, fiberglas core; just right for most small sets. 100 ft. of pre-stretched Standard Cord, fiberglas core; finest quality. 100 ft. of Medium Cord, recommended for larger table models and consoles. With this assortment you can replace Cord on practically any set made since 1934.

**MAIL TODAY**

**Olson Radio Warehouse**  
73-D Mill St., Akron, Ohio

Please send me the Thrifty Cord Rack with 300 ft. of Cord in three sizes. I enclose \$4.87 plus 13c postage.

NAME.....  
ADDRESS.....

# LOW-VOLTAGE RECEIVER

By PAUL ABRAMSON

THE regenerative grid-leak detector followed by several stages of amplification has long been the standby of "hams" and experimenters. It involves a minimum of expense and knowledge to build and when properly operated gives results comparable in sensitivity and selectivity with many superhets. In addition to this, it has been found that the values of the components are not at all critical, so that good operation is obtained under a wide range of values.

The requirements of this type of a receiver call for some type of a remote cut-off high gain pentode, a high-gain voltage amplifier, and a power output tube. The combination which was most preferred until several years ago, was the "57," "56," and "2A5." Later, the 6 volt filament equivalent of these tubes such as the "6D6," "76," and "42" became common.

Recently, I became interested in trying this type of circuit on new type tubes and consequently re-designed it for a "6AC7" grid leak regenerative detector, a "6SJ7" amplifier, and a "6L6" power stage. The results, using an orthodox circuit and a 250-volt plate supply, were extremely good, the output being considerably more than necessary for a 12-inch P.M. speaker.

This set is operated in the same manner as all others of its type. A common difficulty, lack of regeneration, is usually corrected by reversing the tickler winding on the tuning coil. In tuning, it was found that the trimmer condenser exerts a considerable influence and should be readjusted for maximum selectivity, especially when changing from a low-frequency station at approximately 600 Kc. to one at 1600 Kc.

## OPERATION ON 18 VOLTS

This receiver was built in a school laboratory and was used for instruction. Due to a shortage of power supplies, it was decided to run the set on batteries. Three 45-volt "B" batteries in series produced results comparable to the power-supply arrangement. This interested us in examining the effect of low plate voltage. Reducing the voltage in steps and redesigning the circuit, especially the regeneration, brought us to the circuit shown in the diagram. With this set-up, and on an 18-volt battery, the receiver was operating as well as ever, blasting the 12-inch speaker. The principal changes made to allow the receiver to operate on the very low voltage were elimination of most of the regeneration control circuit, the cathode bias resistor and the condenser in the "6SJ7" stage, and the screen dropping resistor in the "6L6."

One of the characteristics of this set operated on low voltage is that it will not go into oscillation when the regeneration

control is turned on full. Due to this fact, we may use the regeneration control as a volume control without any difficulty.

It is possible that the use of inductances instead of resistors in the plate circuits would give even louder signals, but in this case it was not necessary. The network in the plate circuit of the 6SJ7 is for tone compensation. The coils L1 and L2 were an ordinary broadcast plug-in coil to start with, though with the 140-mmf. condenser the whole broadcast band could not be covered. A 365-mmf. condenser would be necessary for that. As voltage was reduced, it was necessary to add turns to the tickler to increase regeneration. In winding one's own coils, it would be correct to start with about 90 or 100 turns of No. 28 enamel on a 1½-inch form, with 30 turns of smaller wire as the first approximation, on the tickler. The deciding factor was voltage ratio to the tube elements rather than tickler adjustments, which were not decisive. The 0.5 megohm potentiometer, for example, was one necessary modification of the standard circuit.

Further experimentation with the receiver brought out several other interesting facts. It was found that operation is satisfactory on 12 volts plate voltage if a small 3-inch speaker is used. Furthermore, using only 6 volts we obtained good results with headphones.

Since the gain of the "6AC7" detector-amplifier is very great, the circuit was changed slightly and the "6SJ7" tube eliminated entirely. The output of the "6AC7" was coupled directly to the grid of the "6L6" through a condenser, thus by-passing the "6SJ7." The voltage, however, in this case, had to be raised to 45 in order to obtain sufficient output to drive the 12-inch speaker.

## ADAPTED TO PORTABLE USE

It is my opinion that a circuit such as described here may be designed for portable use, and would provide an extremely light and compact receiver with as great an output as desired. Low-current-drain heater tubes, of course, would have to replace the tubes used here. This set is now under construction and will be described as soon as satisfactory operation is obtained.

A circuit of this nature very well illustrates the versatility of modern vacuum tubes. The tubes used, especially the "6L6," were designed for use with plate voltages of at least 100 volts. Since we find that 18 volts on the plate produces characteristics which are useful in modern radio circuits many new applications should be developed for these tubes, particularly in portable apparatus.

The 0.5-megohm regeneration control, plate resistor of 150,000 ohms and 500 mmf by-pass condenser were found to give best regeneration at low voltages. The number of tickler turns remained approximately the same as with high voltage applied to the plates.

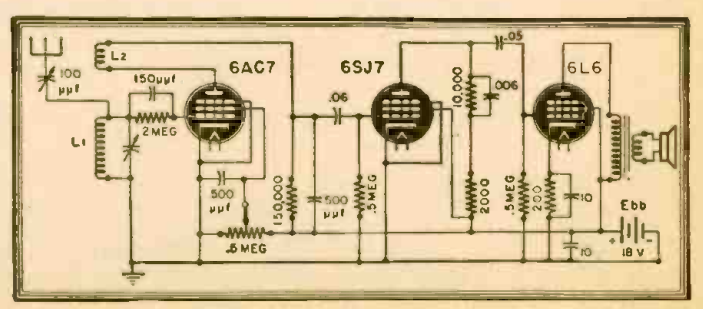



## AMATEURS AND POSTWAR RADIO

(Continued from page 483)

### WHAT KIND OF TRANSMITTER?

The transmitter should be the third item acquired. The post-war period is going to offer so many wonderful gadgets that it is going to be a problem where to start. Almost all the hams have their own individual ideas about the best way to do it. There are no fixed rules. The FCC regulations are extremely flexible, requiring observation of power and frequency laws principally. Build with the best components available! There is nothing to prevent you from putting a crystal oscillator on the air, and gradually adding stages. The results which are readily obtained with low power are amazing . . . provided a good antenna set-up is available. It doesn't hurt to mention the friendly controversy between phone and CW men, because sooner or later someone brings it up. A fellow should enjoy both types of communications.

Ham radio is far more than slapping together a station. No words can adequately describe the thrill from contacts on a transmitter built in a basement shop. When some friend standing across the lawn with a RF measuring device tells you that the signal drops to zero off the ends of the rotary beam, you'll know that Marconi is watching out for his laurels. QSL cards are also a part of amateur radio. They are printed verification cards exchanged with a station, confirming a contact. Individual stations use different designs, each trying to have the best looking one.

### CONTESTS AND MEETINGS

On the air there are all kinds of special amateur activities to be enjoyed. Such an event is the Sweepstakes Contest. The idea is to have as many contacts with as many different stations as possible in a given time limit. There is also the DX contest to see who can work the most countries and foreign stations. If you are not interested in that sort of thing, you can go right on testing and experimenting. You'll get to know many amateurs at the "hamfests" that are held all over the country in peacetime. Technical talks, open house discussion, good food and fun make them something to be looked forward to.

Being a ham has a lot of good points, many of which you will need in self-de-

fense in case the little woman doesn't see eye to eye with your absorption in the hobby. One of the easiest methods of overcoming this obstacle was becoming quite popular prior to the war. Many of the boys started to train the XYL. (Ex-young-lady, or wife.) Combination man-and-wife stations were quite commonplace, and will increase greatly in the future, due to the number of women with radio training obtained during the war.

Not all of ham radio is experimenting or chewing the fat. On almost every band there were networks extending from coast to coast and to most of the American possessions.

### THE TRAFFIC NETWORKS

These networks handled traffic, free of charge. The only stipulation was that it must not be commercial traffic. Because these services are free, handling or delivery was not guaranteed. The pleasure that comes from helping others has developed a code of ethics which seldom saw non-delivery of messages. Emergency networks manned by amateurs are playing an important wartime job in the WERS. In almost every national disaster, it was local hams who were able to first establish communications and play a vital part in emergency work. Our country was dotted with emergency coordinators, assistants, and a trained pool of men ready to serve at an instant's notice. The technical achievements of the amateurs are unsurpassed by any group of people in the world.

Their service to humanity in times of need closely rivals their contributions in the art of radio. The technical proficiency it has afforded the armed services, the gigantic radio industry which was largely supported by amateurs; and the hours of enjoyment it has brought thousands, makes amateur radio a unique hobby. After the war it may serve a new purpose, as an instrument of good will among nations. Those who plan on entering this wonderful hobby must remember they are assuming the responsibility of keeping ham radio great. It is a big order, but now is the time to start thinking about it. Come on in . . . the water's fine!



Suggested by:  
E. M. Pave, Vicksburg, Miss.

"I don't know what beach combing's come to!"

You Never Saw a Drafting Machine  
do so many things!



Favorite of professionals—  
complete help to amateurs  
and beginners.

### The MASTER

Here's quality equipment  
mounted on a 24" x 20 1/2"  
Masonite board: Crystal-  
clear strong plastic mecha-  
nical square, 4 scales, 8th  
and 16th in.; protractor full  
degree graduation; nine  
cutout circles 1/16" to  
3/8" dia.

All me-  
chanical  
drawing,  
Layouts  
Lettering  
Sketching  
etc.

only \$3.95

Adjustable, self-alignment metal  
arms. Equipment locks in any posi-  
tion. Accurate, useful. Guaranteed  
as advertised.

Get your order in right NOW! Sup-  
ply is limited and they're going fast.  
Write for radio parts circular.

RANDOLPH RADIO STORES  
Dept. F  
609 W. Randolph St., Chicago 6, Ill.



Do you need

### BINDING POSTS?



The XL PUSH POST with its Spring  
Action assures Constant Contact and  
quick connection.

Manufactured in All Aluminum Type M

at 12c each.

Aluminum Body, Bakelite Top Type B1

at 15c each.

Types CP or NP. ALL BRASS—STAIN-  
LESS STEEL, SPRING & PIN. PROVEN

by 240 HR. SALT SPRAY TEST as NON-  
CORROSIVE at 28c each.

Manufacturers and Dealers Liberal  
Discounts

X. L. RADIO LABORATORIES

420 West Chicago Ave., Chicago 10, Ill.

BY THE AUTHOR

1700

ANSWERS

TO YOUR  
HARDEST PROBLEMS

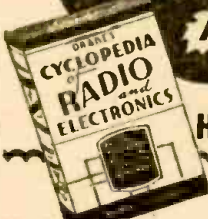

1178 Illustrations

1000 Pages

130 Tables — 105 Graphs

### GET THE ANSWERS NOW!

Here, in one big volume, you'll find all the time  
saving answers to your radio problems . . . and time  
saved is MONEY EARNED. Written in easily un-  
derstood language, yet accurate enough for an engi-  
neer. Completely revised and cross indexed for quick  
reference, this handy reference book for your tough  
jobs covers radio transmission and reception, public  
address systems, television, photocells and data on  
their important parts. It's a book you'll  
always use. And . . . It's only . . . \$5.00

### ANOTHER TIME SAVING BOOK!

ELECTRICAL AND RADIO DICTIONARY. Over  
3800 definitions of technical words and terms used  
in all branches of radio and electricity.  
300 Pages—550 Illustrations . . . \$2.50

GATEWAY PUBLISHING COMPANY

53 W. Jackson—Dept. RC-5

Chicago 4, Ill.

### Clip This Coupon NOW

- Send me the new Drake Cyclopedia  
IMMEDIATELY.
- And the 300 Page Radio Dictionary.

Name .....

Address .....

City ..... State .....

BROADCAST stations have lost 30% of  
their personnel to the armed forces, accord-  
ing to *Broadcasting Yearbook*. Nearly 8,000  
men and women, representing 900 stations,  
are in the forces. Only six stations report  
no personnel with the armed services.



# ELECTRONIC ENGINEERS!

**War - Winners Today, Post - War Builders Tomorrow!**

Leaders in NATIONAL UNION RADIO CORPORATION'S staff of engineers, scientists and technicians have brought us far out in front in the electronics industry. We have a research laboratory and two manufacturing plants in Newark, N. J., and a manufacturing plant near Philadelphia, Pa. We invite you to consider your opportunities with us for professional advancement, stimulating, friendly associations, and a future with promise.

## NATIONAL UNION NEEDS:

**SENIOR TUBE ENGINEERS:** These men **MUST** have actual experience with radio tube manufacture. The pay and opportunities are commensurate with your ability.

**COMMERCIAL ENGINEERS:** Engineers interested in developing electronic tube applications, who may represent us among radio manufacturers upon occasion.

**QUALITY CONTROL MEN AND WOMEN:** Here you need an interest in the practical application of statistical and/or engineering procedures to many factory processes.

**TEST EQUIPMENT ENGINEERS:** Men experienced with meters or electronic test equipment to work either as **TEST EQUIPMENT DESIGN ENGINEERS** or as **MEASUREMENT LABORATORY ENGINEERS**.

**JUNIOR ENGINEERS—MEN AND WOMEN:** Do you have a college degree in Physics, Electrical Engineering, Chemical Engineering, Mechanical Engineering, Mathematics or Chemistry? This company offers an opportunity for young, ambitious graduates to assume responsibilities and to exercise initiative.

**FOREMEN AND ASSISTANT FOREMEN:** Men experienced in radio or radio tube manufacture to supervise exhaust, stem or grid operations.

**TECHNICIANS, CIRCUIT MEN:** Have you been a radio ham, or have you built or repaired radios? Have you studied radio in the Services? We need men who can read circuit diagrams and do wiring and construction.

## WOMEN!

*We have a number of fine young women engineers with us now. We need more. If you have a degree in Electrical Engineering, Chemical Engineering, Mechanical Engineering, Physics, Chemistry or Mathematics and are seeking career opportunities, investigate.*

If you have thorough training in your field, as evidenced by job experience in radio or allied industries, or by a college degree—if you have ambition, initiative and resourcefulness—if you have the ability to inspire your co-workers, then . . .

Phone or Write

**DR. L. GRANT HECTOR**

Director of Engineering

## NATIONAL UNION RADIO CORPORATION

Plane St. at Raymond Blvd.

Newark 2, New Jersey

**WMC RULES OBSERVED**

## WANTED

### RADIO LICENSED AMATEURS

thoroughly familiar with all types of parts, tubes, meters, test equipment, receivers, transmitters, etc. Permanent position; excellent salary; splendid opportunity for some one residing in metropolitan New York area.

**SUN RADIO & ELECTRONICS CO.**

212 Fulton Street

New York 7, N. Y.

### ELECTRICAL and RADIO ENGINEERS RADIO TECHNICIANS

For Design, Development and Production Work. Post-war Opportunity. Also Openings for Mechanical Draftsmen, Junior and Senior Designers.

**ALLEN D. CARDWELL MFG. CORP.**

81 Prospect St.

Brooklyn

## FIELD SERVICE ENGINEERS

For Domestic and Foreign Service

Must possess good knowledge of Radio

Essential workers need release.

## HAZELTINE CORPORATION

58-25 Little Neck Parkway  
Little Neck, Long Island

## RADIO STATION TECHNICIANS

MEN AND WOMEN

for Point-to-Point International Radio-Telegraph Stations in the United States.

Applicants must possess FCC radio-telegraph commercial license, and ability to copy International Morse code at about 20 wpm.

WMC rules observed.

Apply weekdays except Saturdays between 10 am and 3 pm

or write

PERSONNEL DEPARTMENT

**RCA COMMUNICATIONS, Inc.**

64 BROAD STREET  
NEW YORK 4, N. Y.

## A RADIO CONVENTION?

Education by air suffered a setback due to the ban on unnecessary travel, Dr. I. Keith Tyler, director of the Institute and of radio education at Ohio State University, announced last month. The possibility remains that the Institute may use radio to circumvent the disability.

Said Dr. Tyler: "It was deemed inadvisable to continue with the 'Institute' this year in view of the Office of Defense Transportation's suggested national ban on large conferences and conventions.

"However, there will be an 'institute' in 1945. We are studying the possibility of a closed circuit broadcast, with prominent men and women in commercial radio, the armed forces, government and education taking part. Whether or not this plan is carried out, the annual Institute yearbook will be published and will contain the views of qualified experts in the United States and Canada on problems of radio in the war and post-war period."

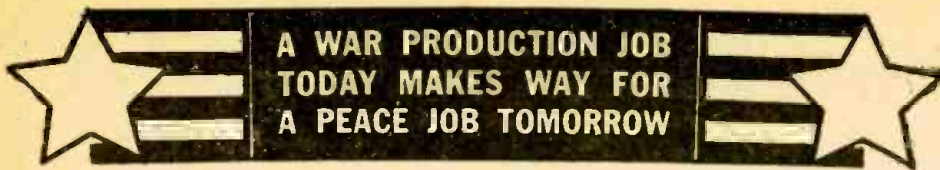

## Wanted ENGINEERS

### Radio

\* Electrical

Electronic

\* Mechanical

\* Factory Planning

Materials Handling

Manufacturing Planning

Work in connection with the manufacture of a wide variety of new and advanced types of communications equipment and special electronic products.

Apply for writel, giving full qualifications, to:

R.L.D., EMPLOYMENT DEPT.

**Western Electric Co.**

100 CENTRAL AV., KEARNY, N. J.

\*Also: C.A.L.

Locust St., Haverhill, Mass.

Applicants must comply with WMC regulations

### WANTED

## TRANSFORMER & SMALL ELECTRIC MOTOR MEN

### ENGINEERS DESIGNERS DRAFTSMEN TECHNICIANS

For war time and post-war design and development of intricate, specialized, hermetically sealed transformers, and special purpose fractional h.p. motors.

Write, giving details about age, experience, past salaries to

## SPERRY

GYROSCOPE COMPANY, INC.  
RESEARCH LABORATORIES  
STEWART AVE. AND CLINTON RD.  
GARDEN CITY, NEW YORK

### EXPERIMENTS WITH FM

FM broadcasters are at present undertaking, with the help of the FCC's Engineering Department, the widest series of transmission tests so far attempted. Reason for the experiments is the proposed new spectrum between 84 and 102 megacycles, concerning which much more should be known.

Long-distance interference between present FM stations, while not common, was frequent enough to cause some apprehension as to conditions should hundreds of stations get on the air in the United States. "Bursts" were another form of interference which might conceivably be troublesome with a greatly increased number of stations. For this reason, the proposed new allocations are in the neighborhood of 90 megacycles. While it is anticipated that little interference trouble will be experienced in those regions, other transmission characteristics of the region are not well known.

Among the stations taking part in the experimental work are WMFM and W9XJC of Milwaukee, who are working with "booster" stations scattered near the edge of the service area. KLZ of Denver is another station experimenting with boosters in areas of low signal strength.

New types of antennas are being tested by four stations, WHDH-W1MXR of Boston, WEOA, WGBF and W9XEV of Evansville, Indiana, W4XAJ (operated by

WSB) Atlanta, Georgia, and W4XCT of Chatanooga, Tennessee. The skypieces undergoing trial include biconical horn radiators, vertically polarized antennas and stacked corner reflector types.

Earlier protests against the change in the FM band are decreasing in number and volume as the probable advantages of the new spectrum are becoming better understood. Latest to support the FCC allocation was William J. Halligan, president of Hallcrafters Co., Chicago, who last month commended the FCC on its proposal to move FM to the 84-102 mc band. Police and amateur experiences in the 30-60 mc area show long-distance interference, he said. FM above 80 mc will assure the public a high fidelity service free from static and man-made disturbance, and from any danger of interference from a distant FM transmitter on the same frequency, he asserted.

Mr. Halligan discounted the economic phase as "not too serious", contending only a comparatively few transmitters operate in the 42-50 mc band.

### SOUND IN AN ENVELOPE

PLASTIC records used in a new electronic dictation device are so thin and flexible that they may be folded and mailed without damage. The records are seven inches in diameter and carry fifteen minutes of recording on each side. These "sound in an envelope" discs, as the manufacturer calls the mailable recordings, can even be written on with a pencil without harming the sound track.

It is possible that the postwar office may have an electronic dictating machine and a good phonograph instead of a stenographer.



### PUT YOUR HOBBY TO WORK

Is radio, mechanics or electricity your hobby, or are you interested in becoming a draftsman or engineer? Would you like to work at it in the engineering laboratory of a long-established, growing company, having postwar products with established markets? We have openings for persons with such aptitudes to assist our developmental engineers. Formal scientific education is not a requirement. Our company is located in a small, friendly city in the heart of Connecticut. It is large enough to offer good opportunity for advancement... not so large that individual ability is overlooked. Write me about your qualifications and salary requirements. Your letter will be treated with complete confidence.

**William R. Curtiss, Chief Engineer**

Connecticut Telephone & Electric Division

**GREAT AMERICAN INDUSTRIES, INC.**

99 Britannia St.

Meriden, Conn.

**Just Off Press!**

**THE BLUE BOOK**

**Supplement No. 3  
to the  
"RADIO TUBE SUBSTITUTION  
and CHANGE-OVER MANUAL"**

**Price . . 50c**

**Preceding Issues**

"Radio Tube Substitution and  
Change-Over Manual"  
(Code: Black) . . . . . \$1.00

Supplement No. 1 (Code: Yellow) .50

Supplement No. 2 (Code: Green) .50

Contain

- 10 Substitutes for 12SA7
- 7 Substitutes for 12AB
- 14 Substitutes for 50L6
- 11 Substitutes for 35Z5
- 9 Substitutes for 12K7  
and many others

**See Your Parts Jobber or  
write to**

**OELRICH PUBLICATIONS**

1627 So. Keeler Ave. Chicago 23, Ill.

**LAKE**

**Radio Cabinets & Parts**



Portable Phonograph case, of sturdy durable plywood, in handsome brown leatherette finish. Inside dimensions 10 1/2" long, 14" wide, 9 1/2" high. Has blank motor board. As illustrated above, specially priced at . . . . . **\$6.95**

Also blank table cabinets of walnut veneer in the following sizes, with speaker opening on left front side. (Note: 7" has center speaker grill.)

#1 — 8 1/4"	L x 5 1/2"	H x 4"	D	\$1.95
#2 — 10 1/4"	L x 6 1/2"	H x 5"	D	\$2.75
#3 — 13 1/2"	L x 7 1/2"	H x 6 1/2"	D	\$3.25
#7 — 10 1/4"	L x 7"	H x 5 1/2"	D	\$2.50
#8 — 17"	L x 9"	H x 9 1/2"	D	\$4.50
#9 — 21"	L x 9 1/4"	H x 10 1/2"	D	\$5.50

\*Speaker Opening in center of front side. Cabinets available in ivory color and Swedish Modern. Write for prices.

**POWER TRANSFORMERS**

4, 5, or 6 Tube—6.3V at 2 amp.  
50 Mill Power Transformer . . . . . **\$2.45**

7, 8, or 9 Tube—6.3V at 3 amp.  
70 Mill Power Transformer . . . . . **\$2.65**

All types of radio parts available in today's market can be obtained at Lake's money-saving prices.

Write For Our Free, New Illustrated Catalog!

**LAKE RADIO SALES CO.**

615 W. Randolph Street, Dept. C, Chicago 6, Ill.

**Ted McElroy**

World's Largest Manufacturer of  
Wireless Telegraphic Apparatus  
COMPLETE CENTRAL OFFICE EQUIPMENT

**McElroy Manufacturing Corp.**

82 Brookline Avenue • Boston, Massachusetts

**Communications**

**LICENSES—BUT WHAT KIND ARE REQUIRED?**

Dear Editor:

Many of our *Radio-Craft* correspondents seem to feel that a license and a college education are necessary for proper repairing. I don't believe a college education is necessary, and I don't believe a license is necessary or even advisable. We have far too many laws and too much local interference and too many taxes already. But if some of these folks feel that a license is absolutely necessary and an examination should be given, WHAT kind of an examination should it be?

From some statements made by said correspondents, they would force a repairman to be an engineer in order to earn a living. May I ask what higher mathematics and physics have to do with repairing radio sets or television, or vacuum sweepers or any other electrical appliance? Absolutely nothing.

I maintain a good radio man should be a first class mechanic and *not* an engineer. If he is able to handle ordinary mathematics, can read schematics, can follow manufacturers' instructions to the letter, and knows an instrument from a soldering iron, his only other requirements should be:

1. He must be honest.
2. He must be absolutely reliable.
3. He must be a *good* mechanic.
4. He must like this work better than any other kind of work.

No form of licensing or taxing will guarantee the above, in the remotest degree.

To illustrate:

My best repairman was never able to complete the eighth grade. He works rapidly and accurately. His work is workman-

like and stays done. His comebacks are nil. On the other hand, the poorest man I ever had was a graduate E.E.R.E. of one of the largest schools in the East. He knew his higher mathematics all right. He could read a slide rule faster than most folks can read a newspaper. In fact, he spent about two-thirds of his time using said slide rule trying to show us what dopes most of our R.C.A. and Philco engineers really were, what cheap material they used, how poor their cabinets were, and so forth. In the meantime, half his jobs were comebacks.

Now, don't misunderstand me. I am in favor of education and I believe any good workman will study constantly in order to improve his standards of work. The point I am illustrating is that my best man could *not* pass an examination such as most folks apparently feel should be given a repairman. And my poorest man could pass this same examination very easily. And he still wouldn't be worth a damn to anyone, license or no license.

So, if an examination and license (by the way, almost every city makes you pay a business license now) are still to be required, WHAT KIND of an examination and WHAT KIND of a license?

JACK GEIER,  
Northridge, Calif.

(It would seem that a repairman who can turn out work like that described above would be able to pass any reasonable examination, eighth-grade education or no eighth-grade education. Few indeed are the servicemen who have *no* comebacks.—*Editor*)

**FOX-HOLE RADIOS AND METAL-FILM DETECTORS**

Dear Editor:

As an interested reader of your Electrical and Radio publications for the past twenty-five years, the recent articles, Hugo Gernsback's "40 Years of Home Radio" and the "Fox-hole Emergency Receiver" reminded me of some very interesting experiments I stumbled on many years ago and the surprising results attained from contact detectors as described in the articles above.

I discovered that the sweat of the hands in contact with the various metals comprising experimental crystal receivers had given them rectification qualities.

Brass or plated balls, crystal cups, etc., would act as rectifiers if a trace of such corrosion was present. It was reasoned that it must be the high sulphur content of the body acids that caused such corroded surfaces to act as a rectifier. Various metals, such as silver, brass, copper, etc., were immersed in a concoction of Sulphur Flowers and Lard for 24 hours, forming a light sulphide film on their surfaces.

All were converted into super-sensitive radio detectors, in contact with untreated similar metals, especially aluminum. Direct contact with sulphur fumes will convert a metal, its corroded surface of sulphide forming a perfect detector.

A treated copper wire laid across the aluminum plates of a tuning condenser of most any crystal set in substitution of the

crystal proper will rectify as well, and in some instances better than the crystal. For simplicity, sensitiveness, such sulphide-coated metals in contact with various metals, especially aluminum, far exceeds the acid, metal, or crystal combinations of olden days.

Joseph D. Amorose of Richmond, Va., in a letter to *Radio-Craft*, Jan 1945, commenting on experiments with the Fox-hole receiver, states "I found I could bring in music with just a catwhisker lighting touching the crystal cup holder." Here Mr. Amorose had accidentally discovered the rectifying properties of sweat corroded surfaces as above. He further states that two spring clips in light contact would also rectify such as a crystal.

The experiments as above may be of value of budding radio enthusiasts of the crystal set stage and many happy hours of experimenting can be enjoyed with these sulphide detectors in combination with various metals, also crystals included.

In closing, may I give my deepest appreciation and praise for your splendid magazines and to Mr. Gernsback for his many encouraging editorials. I only sigh for the good old experimental days. However, a great deal of satisfaction can be obtained thumbing through the old faded copies cherished in the attic relics of by-gone days.

R. F. DILLIMORE,  
New Westminster, B. C.

# FOR SALE HARD-TO-GET ITEMS

All items are brand new, except where indicated. ALL are in PERFECT WORKING ORDER. In many cases, the parts alone total more than the price we are asking. Satisfaction guaranteed or your money back. ORDER FROM THIS PAGE. Use our convenient coupon. Include sufficient extra remittance for parcel post charges, otherwise order is sent express collect. Any excess will be refunded. All C.O.D. shipments require 20% deposit. No C.O.D. shipments on orders for less than \$5.00, if full remittance accompanies order deduct 2% discount. Send money order, certified check, or new U. S. stamps. No C. O. D.'s to foreign countries.

## THE MAGIC ELECTRIC WELDER

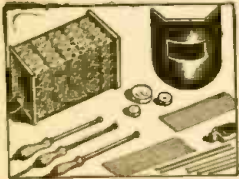

Here is one of the most compact, practical welders we have ever seen. Anyone can use it for shop, farm and home repairs. WELDS, BRAZES, SOLDER, CUTS ALL METALS. ANYONE CAN OPERATE IT. Repairs steel, cast iron, aluminum, brass, copper, bronze, etc. Complete with power unit, flame and metallic arc attachment (one). Carbons, fluxes, etc. Used by the U. S. Navy, American Tel. & Tel. Co., Eastman Kodak Co., Bell Laboratories, etc. BRAND NEW OUTFIT. Guaranteed for one year. Simple instructions with each set.

ITEM NO. 158  
YOUR PRICE ..... \$19.95

## WESTERN ELECTRIC BREAST MIKE

This is a fine light-weight aircraft carbon microphone. It weighs only 1 lb. Mike comes with breastplate mounting and has 2-way swiveling adjustment so that it can be adjusted to any desired position. There are 2 woven straps, one goes around neck, the other around chest. Straps can be snapped on and off quickly by an ingenious arrangement. This excellent mike can be adapted for home broadcasting or private communication systems. By dismounting breastplate, it can be used as desk mike. Comes complete with 6-foot cord and hard rubber plug. Finished in shoradized plate, non-rustable. THIS IS A BRAND NEW MIKE. IT HAS NEVER BEEN SOLD AT SUCH A LOW PRICE BEFORE. ORIGINAL LIST PRICE \$18.00. Shipping weight, 2 lbs. ITEM NO. 192  
YOUR PRICE ..... \$2.55

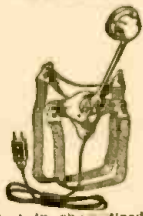

## POWERFUL ALL-PURPOSE INDUCTION MOTOR

IDEAL FOR EXPERIMENTERS—308 USES

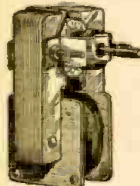

Sturdily constructed to precision standards, this self-starting shaded pole A.C. induction motor is powerful enough for a number of uses. Some of these are: Automatic Timing Devices, Current Interrupters, Electric Fans, Electric Chimneys, Window Displays, Photocell Control Devices, Electric Vibrators, Small Grinders, Buffers and Polishers, Miniature Pumps, Mechanical Models, Sirens, and other applications. Consumes about 15 watts of power and has a speed of 3,000 R.P.M. When geared down, this sturdy unit will constantly operate an 18-inch turntable loaded with 200 lbs. dead weight—THAT'S POWER! Dimensions 3" high by 2" wide by 1 1/4" deep; has 4 convenient mounting studs; shaft is 1/8" long by 3/16" diameter, and runs in self-aligning oil-retaining bearings. Designed for 110-20 volts, 50-60 cycles, A.C. only. Shp. Wt. 2 lbs. ITEM NO. 147  
YOUR PRICE ..... \$2.50

## LIMITED QUANTITIES! PROMPT SHIPMENTS!

It's Easy to order—Clip Coupon—Order from This Page—No Catalog Sent.

MAIL TODAY—NOW!

(See corresponding ad page 526)

HUDSON SPECIALTIES CO.  
40 West Broadway, Dept. RC-5-45, New York 7, N.Y.

I have circled below the number of the items I'm ordering. My full remittance of \$..... (include shipping charges) is enclosed. (C.O.D. ORDERS UNLESS ACCOMPANIED WITH A DEPOSIT.)

OR my deposit of \$..... is enclosed (20% required), ship order C.O.D. for balance. NO C.O.D. ORDER FOR LESS THAN \$5.00. (New U. S. stamps, check or money order accepted.)

Circle item No. wanted 147 152 168

Name .....

Address ..... Please Print Clearly

City ..... State .....

Send remittance by check, stamps or money order; register letter if you send cash or stamps.

## MORE VIEWS ON LICENSES

Dear Editor:

Why should radiomen be licensed, all radio establishments are required to have a city license to do business.

The so-called screw driver man has seen his day, for the present and future radios are too complicated for his screw driver.

Let us forget him for a while and strive to build up our standard of living and put our occupation in the professional class, where it should be.

It's not the screw driver man who held the radio serviceman down, it's the serviceman himself, the majority of servicemen. They don't know what the word cooperation means, they refuse to work together, they are jealous of each other; each one thinks he knows more than the other fellow. As long as these conditions exist, their fate is sealed.

It has become absolutely necessary that the serviceman educate himself in the art of cooperating with his fellow-man. If we continue to operate and work as individuals, we can hope for no better conditions; they probably can get much worse, and probably will, when the hundreds of new manufacturers get in the fight after the war and with the thousands of ex-soldier radiomen return to enter the service business.

The manufacturers, jobbers and distributors learned years ago that cooperation and sticking together was their only salvation. How does the serviceman expect to maintain a fair standard of living, or build up his occupation, without the benefit of association or cooperation?

If the servicemen were organized or had an association backing them like the manufacturers and distributors have, they could control the distributors, manufacturers and even the screw driver man.

I wonder how many times each serviceman has worried and cursed over a two-by-four midget, that should have never been made? How many times has he searched for an outlaw schematic not to be found. Distributors have not all been playing fair with the servicemen; some are now selling critical tubes and batteries to non-service organizations, what is the serviceman to do about these conditions, he can do nothing as long as he works alone, REMEMBER, ISOLATION ALMOST PROVED DISASTROUS FOR THE UNITED STATES.

Let us get an association or organization as strong as the strongest, fight together, work together and rise together; in this way and this way only, will the serviceman ever be placed in the professional class and receive the remuneration due them.

I am trying to organize an association of servicemen in South Georgia, and would like to hear from anyone interested, we plan a meeting in the near future, to work out the details and form some plan of operation and would like to have a big attendance.

G. E. RENFROE,  
Thomasville, Ga.

## NO TUBE DUPLICATION!

Dear Editor:

How about a little propaganda against duplication of tubes having similar electrical characteristics but slight physical differences? The number of types a serviceman should carry in stock, if he could get them, is beyond reason.

Well, cheerio for now.

WO1 GAULT E. F.,  
R.C.A.F. Overseas.

# RADOLEK

## Radio-Electronic Service Parts

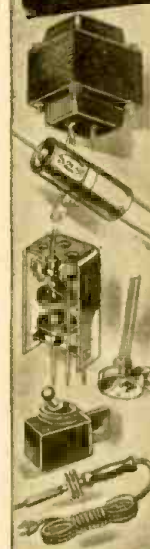

Large stocks assure the finest and most complete selections of all available items at lowest prevailing prices. Thousands of active buyers depend on us for their entire Radio repair and replacement requirements. Because we understand service problems, every order is expedited for delivery in double quick time. Everything we do is planned for convenience and satisfaction to our customers. You will find it profitable to make Radolek your buying headquarters.

## FREE BUYING GUIDES

Because of existing conditions we keep our customers right up to the minute on available merchandise by releasing supplements frequently instead of sending our regular Big Profit Guide once a year. Send the coupon now to get these Free Buying Guide Supplements as they are issued.

FREE!



## FAST SERVICE!

RADOLEK CO., Dept. C-102  
601 W. Randolph St., Chicago 6, Ill.

Please send FREE Buying Guide Supplements

NAME .....

ADDRESS .....

## ORDER FROM RADOLEK



Our Headphones are used by the United States, Canadian, New Zealand and South African Governments as well as other Governments not directly in the war.

Headset

Headquarters

Scientifically Built Heavy bar magnets greatly increase their efficiency.

Folder R5 illustrates rugged, unusually sensitive, dependable Cannon-Ball Headsets.

Write  
C. F. CANNON COMPANY  
SPRINGWATER, N. Y.

## LEARN ELECTRICITY

12 WEEKS SHOP TRAINING



"LEARN BY DOING" IN COYNE SHOPS

Electricity offers you opportunities for the best jobs today—with a real peace time future. "Learn by Doing," on real machinery. Earn while learning. Right now I'm offering extra training in Industrial Electronics at no extra cost. Lifetime employment service after graduation. Get all-round practical training at Coyne in 12 weeks. If you are short of money I'll finance your training. Mail coupon now for Free Book. We have facilities for men with physical disabilities. If you have a physical disability of any kind check coupon below for details.

H. C. LOYD, President, COYNE ELECTRICAL SCHOOL  
500 S. Paulina St., Dept. 55-78, Chicago 12, Illinois

Send free book and all details.  Send physical disability plan.

NAME .....

ADDRESS .....

CITY ..... ZONE ..... STATE .....

## Guaranteed Rebuilt Radio VIBRATORS—\$1.00 ea.

Send old vibrator. For very prompt delivery, enclose remittance and return postage. We rebuild any make or kind of vibrator. Send your old vibrator to  
BEST VIBRATOR CO., Box 5802-Z, Cleveland 1, O.

# AMPLIFIER MANUAL

By **A. C. SHANEY**

Chief Engineer, Amplifier Co. of America

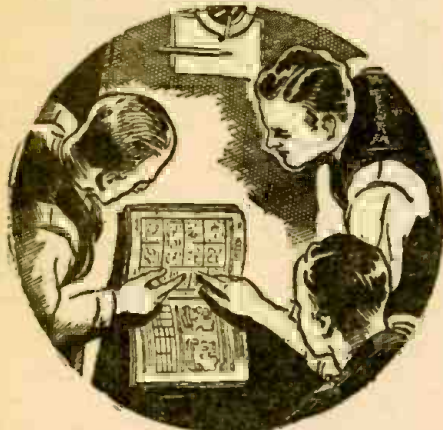

**For the Layman, Serviceman  
Recordist and Engineer**

Regardless of whether you are interested in the finest type of phonograph reproduction, high fidelity recording, sound-on-film applications, FM or AM programs, you will find invaluable information in this practical handbook. Written by the leading exponent of direct-coupled amplifiers who has spent more than 10 years improving and perfecting the famous Loftin-White circuit.

**Explains the theory and practical application of:**

- Variable Speed Non-Overloading Push-Pull Expansion
- Non-Frequency Discriminating Scratch Suppression
- Push-Pull Balanced Direct-Coupled Amplification
- Push-Pull High-Frequency Equalization
- Push-Pull Low-Frequency Equalization
- Push-Pull Volume Compression
- Automatic Volume Limitation
- Automatic Volume Control
- Calibrated V. U. Indicator
- Audio Spectrum Control
- Remote Control

If you are interested in the latest audio developments, you can't afford to be without this complete compilation of authentic articles on Direct-Coupled Amplifiers. 32 pages 8 1/2" x 11". Over 100 diagrams and illustrations.

Priced to Cover Cost of Printing and Mailing **25c**  
Send U. S. Stamps or Coin

**AMPLIFIER CO. of AMERICA**

396 BROADWAY

NEW YORK, N. Y.

NATION-WIDE  
MAIL ORDER  
DISTRIBUTORS  
SINCE 1928



**RADIO AND  
ELECTRONIC  
DEVICES**

For...

**TRADE... INDUSTRY...  
COMMUNICATION...  
PUBLIC UTILITY...  
VOCATIONAL AND  
EXPERIMENTAL  
APPLICATIONS**

**BURSTEIN-APPLEBEE CO.**

1012-14 McGEE ST.  
KANSAS CITY 6, MISSOURI

## ELECTRONS TRAIN AVIATORS

(Continued from page 486)

would not have to fly. An actual pilot, experience taught, gained little information about his ship from the "feel" of a heavy airplane in flight. This was a further simplification. However, other factors had to be reckoned with—"loading," the "angle of attack" of wings against air, the block of air in which the plane was flying. Finally, all of this mass of aerodynamical-electrical information was put into the form of circuit information, and the experimenters were ready to build the first trainer.

To make sure that the mockup trainer would "act" just like a real PBM in the air, duplicate motion-picture films were made at intervals of one second of the real instruments of a real PBM in the air and the instruments of the trainer on the ground.

The noise of an actual ship was recorded in the air under varying engine speeds and loads, and duplicated in the trainer, not with whirring motors, but with a sound-track film feeding a large amplifier and battery of loud-speakers. This was coupled to the speed-control circuit of the mockup engine.

Standard controls were set up in the trainer (photo 134131). Once in the gigantic instrument, seated in pilot's or co-pilot's seats, at real radio equipment, peering through the ground speed and drift indicator, or just looking on from the navigator's position with earphone "intercom" carrying messages back and forth, the illusion of actual flying was so realistic that experienced flyers were dumbfounded.

### CONVERTING A CRITIC

One day, shortly after the first trainer was received, an officer fresh from 500,000 miles of flight in all theaters of war arrived to inspect the mockup. He, frankly, was skeptical, and said so. No one, he went on, could teach a PBM flight crew to operate together without actual air experience. He would prove it. Quietly, he was asked if he wouldn't like to try it out before making his report.

Into the mockup he went. The ground crew exchanged significant glances. This skeptic from the front would be convinced. Actually, severe flight conditions can be manufactured by the mockup control room in a room adjoining the actual trainer. Seated at a desk, with duplicates of the trainer's instruments before him, the flight-control can create severe icing conditions, strong headwinds, cause one or both of the trainer's "engines" to quit, cause fouled oil or fuel pipes, increase oil or cylinder-head temperatures, shift the center of gravity, and a number of other things. The idea behind this is to see how the pilot will react to the unusual conditions. The control man sitting quietly at his desk sees all and knows all. By moving a dial or two he can "throw the plane into a nose dive" and cause a technical "crash." The instruments before him tell instantly what the pilot is doing, and how well, to right the trouble.

On the table top is a mercator chart. Atop this chart is an electrical "frog" that moves about in exact accordance with the theoretical flight of the trainer. The navy man from the front, with 500,000 miles of flying experience, wasn't aware that he was to be given the "works." But twenty minutes later he signalled he had enough. The control-room man had all but "crashed" the expert flyer, who emerged from the mockup

## Index to advertisers

Aerovox Corp. ....	510
Allen Manufacturing Co. ....	526
Allied Radio Corporation ....	522
American Microphone Co. ....	468
Amperite Co. ....	527
Amplifier Co. of America ....	534
Audel & Co., Theo. ....	504
Bakersfield Radio Supply ....	527
Best Vibrator Co. ....	533
Buck Manufacturing Co. ....	523
Burgess Battery Co. ....	513
Burstein-Applebee Co. ....	534
Cannon Co., C. F. ....	533
Capitol Radio Eng. Institute ....	520
Cardwell Mfg. Corp., Allen D. ....	530
Cinaudagraph Speakers, Inc. ....	523
Concord Radio Corporation ....	509
Cox, John A. ....	527
Coyne Electrical School ...	507, 514, 533
DeForest's Training, Inc. ....	473
Gateway Publishing Co. ....	529
General Cement Mfg. Co. ....	525
General Electric Co. ....	517
Great American Industries, Inc. ....	531
Hallcrafters Co., Inc. ....	471
Hazeltine Corporation ....	530
Henry Radio Shops ....	519
Hickok Elec. Inst. Co. ....	503
Hudson Specialties Co. ....	526, 533
International Detrola Corp. ....	501
Lake Radio Sales Co. ....	532
Lancaster, Allwine & Rommel ....	527
LeJay Mfg. Co. ....	507
Lifetime Sound Equipment Co. ....	528
McElroy, T. R. ....	532
McGraw-Hill Book Co. ....	535
Maedel Publishing House ....	535
Mallory & Co., Inc., P. R. ....	
Inside Back Cover	
Meissner Mfg. Co. ....	537
National Radio Institute ....	467
National Schools ....	475
National Union Radio Corp. ....	502, 530
Oelrich Publications ....	532
Olson Radio Warehouse ....	528
Onan & Sons, D. W. ....	525
Opportunity Adlets ....	523
Panoramic Radio Corp. ....	538
Personnel Help Wanted ....	530, 531

### RADIO SCHOOL DIRECTORY

Page 536

- American Radio Institute
- Candler System
- Capitol Radio Engineering Institute
- Commercial Radio Institute
- Lincoln Engineering School
- Melville Radio School
- RCA Institutes

RCA Communications ....	530
Radio Distributing ....	523
Radio Electric Service ....	517
Radio Kits ....	523
Radio & Technical Division	
Murray Hill Book Co. ....	498, 499
Radio Tube Service Co. ....	524
Radio Wire Television, Inc. ....	516
Radionic Equipment Co. ....	521
Radolek Company ....	533
Randolph Radio ....	529
Raytheon Mfg. Co. ...	Inside Front Cover
Rider Publisher, Inc., John F. ....	515
Sperry Gyroscope, Inc. ....	531
Sprague Products Co. ....	472
Sprayberry Academy of Radio ....	469
Studio Service Co. ....	523
Sun Radio & Electronics Co. ....	530
Supreme Instruments Corp. ....	518
Supreme Publications ....	519
Sylvania Electric Co. ....	476
Triplet Elec. Instrument Co. Back Cover	
Van Nostrand Co., D. ....	511
Western Electric Co. ....	531
Weston Elec. Instrument Co. ....	507
Wholesale Radio Laboratories ....	521
X-L Radio Labs. ....	529

with perspiration dripping from his chin, his shirt wet, completely spent, and—fully convinced. "I'm cured," he said, "what a machine that is!"

The Navy got the first trainer late last year, but now seven or eight more are installed and doing an unequalled job in the creation of flight crews at Banana River, Fla., Corpus Christi, Texas. Others are in operation or are on the way to all theaters of war, according to latest information.

When a crew takes an actual plane up it is responsible for about \$500,000 worth of equipment and the lives of ten or more men. All the crew must know their jobs, each other's abilities and shortcomings, and must be able—collectively—to meet a great variety of emergencies with instant action. In flight, when a mistake is made, it is generally too late to remedy the situation. A crash often results. Now the old method of assembling promising crews and trying them out in the air is superseded by the electronic method. When mistakes are made in the trainer, they do not result in loss of equipment and lives. The flight-control man, speaking a word or two through the mockup intercom system, merely says: "OK, boys, you are theoretically dead. Come down here and I'll tell you what's the matter." Then, in a matter of minutes, they are briefed again and on a new trial.

Good flying weather, moreover, cannot always be had for the wishing, and the training must go on. With the PBM trainer it can go on in rain or shine, and the only equipment expended is the electric current required to operate the trainer.

#### HOW A TRIAL RUN FEELS

When one enters the one-story building that houses the trainer he finds himself in a bare room with a desk and a dozen chairs. This is where the crews are instructed for flight, or briefed. An instructor explains what is ahead. To the right is a door from behind which comes the staccato drum of powerful motors. You enter that fateful door, finally, after a bedraggled crew emerges, and are on your own. Steep steps carry the visitor to the cockpit. Seats are seen ahead, as one goes through what seems to be a real airplane. You are strapped into one of them, the co-pilot into the other.

#### A FIXED RESISTANCE



Suggested by: E. R. Loving, Weston, Mo.

Others are assigned to the radio equipment, the navigator's table, the drift indicators, the gun position, and so on. The headgear is strapped on over ears and mouth, as a voice over the intercom asks you if everyone is ready.

"Ever been in one of these ships before?" the voice asks. Everyone replies "no." The voice calmly asks the pilot and co-pilot to "take hold of that lever under your seats and move forward as far as you can." This advances the seats so the pilot and co-pilot can easily reach all the controls.

"All right, let's go," the voice orders. "There is no danger, just do as I say," he goes on. "Throttle," orders the voice. We step on a pedal and idling motors spring into life. The airspeed indicator shows a slow rise of speed. "Taxi to position on runway No. 1," the radio man relays, after receiving the instructions from the "operator" in another room, who is directing the take-off. Flux-gate compass swings around as the turn is accomplished, and we are on the runway, ready to go.

"Give her the gas," the flight commander orders, as we press down on the pedal and motor sounds roar. Airspeed indicators show 120 miles per hour. "Tail up," says the voice. We move the elevator control—the ship seems to respond instantly with something that indicates we are level. "More gas," orders the voice. The speed climbs to 180 miles. There is no sensation. "We are off the ground," the voice advises. "More gas." We are now doing 200. A slight waver of the "lever" indicator shows us that we are indeed "airborne." The waver is corrected. The height indicator reads 500 feet, then 600, then 800, then 1000, then 1500 feet, which has been given us as our cruising elevation until further orders. What a sensation! A motor wavers a bit and we get a new thrill. The operator "on the ground" gave us that one by moving a dial a wee bit—caused a bit of bumpy air. He gives us a new one by stopping one motor entirely, then causing it to catch again and go on with a steady purr. What a machine—all man made, electronically controlled! We have a difficult time believing we are not in the air.

The soft voice goes on, bidding us turn "north-north east," for "fifteen miles or so." Then another turn and we are soon back over the Patuxent Base, maneuvering for a landing. We come in, finally, a beautiful three-point landing, taxi up to the starter's booth, shut off the roaring engines and step out—surprised to find ourselves in the same building from which we started our flight. "God," said our girl passenger again, "I'm a little light-headed—get that way often in a train hut flying is worse." Everyone smiles, a little weakly, to be sure, for all of us feel the relief that comes after an ordeal.

#### THE ROOMFUL OF SECRECY

Back in the operators flight-control "tower" again we look over the equipment used to create the hazards of "synthetic" training. The flight man explains how the "crab" followed our "flight" and points out that we received a rating of 80 per cent for our job. Inside the crab are several electric motors that cause it to move in exact accordance with the movement of the controls in the mockup.

"See that little jagged bit of line in red ink?" he asked. "That came when I gave you the bit of motor trouble. You see, I knew not only just what you were doing, but exactly how well you did it; that is, how quickly and accurately you responded to correct the conditions I interposed. This permits us to weed out the men who are slow at such things, who are then given

(Continued on following page)

## NOW—A REALLY HIGH-POWERED— Radio Engineering Library

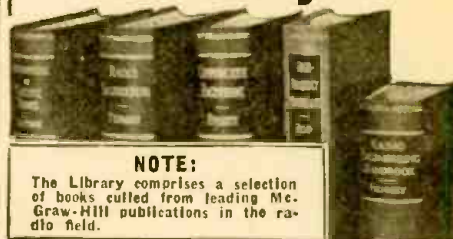

#### NOTE:

The Library comprises a selection of books culled from leading McGraw-Hill publications in the radio field.

- especially selected by radio specialists of McGraw-Hill publications
- to give most complete, dependable coverage of facts needed by all whose fields are grounded on radio fundamentals
- available at a special price and terms

THESE books cover circuit phenomena, tube theory, networks, measurements, and other subjects—give specialized treatments of all fields of practical design and application. They are books of recognized position in the literature—books you will refer to and be referred to often. If you are a practical designer, researcher or engineer in any field based on radio, you want these books for the help they give in hundreds of problems throughout the whole field of radio engineering.

#### 5 VOLUMES, 3319 PAGES, 2289 ILLUSTRATIONS

1. Eastman's FUNDAMENTALS OF VACUUM TUBES
2. Terman's RADIO ENGINEERING
3. Everitt's COMMUNICATION ENGINEERING
4. Hund's HIGH FREQUENCY MEASUREMENTS
5. Henney's RADIO ENGINEERING HANDBOOK

10 days' examination. EASY terms. Special price under this offer less than books bought separately. Add these standard works to your library now; pay small monthly installments, while you use the books.

#### 10 DAYS' FREE EXAMINATION—SEND COUPON

McGraw-Hill Book Co., 330 W. 42nd St. New York 18

Send me Radio Engineering Library, 5 vols., for 10 days' examination on approval. In 10 days I will send \$3.00, plus few cents postage, and \$3.00 monthly till \$24.00 is paid, or return books postpaid. (We pay postage on orders accompanied by remittance of first installment.)

Name .....  
Address .....  
City and State .....  
Company .....  
Position ..... RC-5-45

## MATHEMATICS FOR RADIO

Two volumes, prepared for home study. Book I (314 pp.) covers the algebra, arithmetic, and geometry; Book II (329 pp.) covers the advanced algebra, trigonometry, and complex numbers necessary to read technical books and articles on radio.

MAEDEL PUBLISHING HOUSE Room 117  
593 East 38 Street, Brooklyn, New York

Send me MATHEMATICS FOR RADIO AND COMMUNICATION as checked below. I enclose payment therefor with the understanding that I may return the book(s) within 5 days in good condition and my money will be refunded.

Name .....  
Address .....

- Book I at \$3.75 plus 6c postage  
 Book II at \$4.00 plus 6c postage  
 Books I and II at \$7.75 postage prepaid

Foreign and Canadian prices 25c per volume higher

# RADIO SCHOOL DIRECTORY

PREPARE NOW FOR POST-WAR RADIO AND ELECTRONICS

MAKE a place for yourself in a new world of radio and electronics—a world in which revolutionary electronic developments will require highly specialized technical knowledge. Take a good course now to fit yourself for a good paying job. The training you need can be supplied by one of the schools advertised in this publication.



## RADIO ELECTRONICS

Intensive training in  
Airline, Merchant Marine,  
Press Communications,  
Electronics, Television. Co-  
educational. FREE booklet.

**VETERANS:**  
Request FREE copy, G.I.  
bill of rights

"A Radio School managed by radio men."  
45 W. 45th St., Dept. RC, New York 19, N.Y.

**MELVILLE RADIO INSTITUTE**



## CODE SPEED

Be an Expert

Learn to be a Telegraph or  
Radio Operator. Thousands of  
men needed. Intensely interest-  
ing work—good pay. Learn at  
home or wherever you are, quickly,  
easily, with the famous Candler  
Code Speed System. Book of particulars Free.  
Candler System Co., Dept. 3E, Box 828, Denver 1, Colo.

**FREE BOOK**

## RADIO

Courses Qualifying for  
Service Technician • Laboratory Technician  
(Electronic Television) Communications Operator

Register Now for New Classes Starting 1st Monday of  
each Month. Day and Evening Classes.

Consideration Given to Veterans Eligi-  
ble For Training Under G. I. Bill.

**AMERICAN RADIO INSTITUTE**  
101 West 63rd St., New York 23, N. Y.

## RADIO-TELEVISION

**ENGINEERING & SERVICING**

Now Training Veterans Under "G.I." Bill  
Prepare now for profitable career! ENTER  
AT ANY TIME. Residence school classes in  
Radio-Electronics Engineering, Broadcast &  
Television Engineering and Servicing.  
Write for FREE Booklet

Capitol Radio Engineering Institute  
Dept. RC-5, 3224 16th Street, N. W.,  
Washington 10, D. C.

See Big Ad. Page 520

(Continued from previous page)

intensive training to eliminate the fault." "Is that all there is to the trainer?" we ask, incredulously. "By no means," said the operator. "Just go into that door at your left and see what makes the whole thing tick."

Inside we found a mammoth series of seven electrical panels about eight feet high. Little lights seemed to blink in the semi-darkness. They were thyratrons, well-known gas-filled bulbs that have the useful purpose of controlling the flow of large electric currents when a control-circuit is energized. Motors, nearly 100 of them, either hummed with activity or otherwise, in response to the thyratrons. This was the really secret part of the operational flight trainer, the "brain" by which its mysterious properties are controlled in response to the movement of gadgets in the mockup or control desk. Behind the mysterious panels the blinking thyratrons and rotating motors translated into actuality in an electric circuit everything that the engineers foreordained in months of experimental work in the Bell Laboratories.

Move a control in the mockup or control desk and a thyatron blinks, a motor speeds up or diminishes its rotations per second in terms of some law of aerodynamics, and some condition of actual flight is satisfied. Encounter "trying conditions" of headwinds, motor temperature, oil feed, icing of wings and a dozen other such things and a hun-



## INSTITUTES

Offer thorough training  
courses in all technical phases of

### Radio and Television

DAYS—EVENINGS WEEKLY RATES

**VETERANS:** RCA Institutes is approved  
under G. I. Bill of Rights

For Free Catalog Write Dept. RC-45

**RCA INSTITUTES, Inc.**  
A Radio Corporation of America Service  
75 VARICK STREET NEW YORK 13, N. Y.

## Correspondence Courses in RADIO and ELECTRICAL ENGINEERING

**ELECTRICAL ENGINEERING** Get good grasp  
of wide elec-  
trical field. Prepare yourself, at Low Cost, for secure  
future. Modern, simplified, you can understand quickly.

**RADIO ENGINEERING** Extra fine course in radio, pub-  
lic address, photo-electric work.  
Trains you to be super-service man, real vacuum tube  
technician. Servicemen needed badly. Diploma on comple-  
tion. Tuition \$25, either course. Deferred payment plan.

**FREE** Get copies of school catalogs, student  
magazines, complete details. SEND NOW!

**LINCOLN ENGINEERING SCHOOL** Box 931C-75  
Lincoln, Nebr.

## COMMERCIAL RADIO INSTITUTE

A radio training center for  
twenty-four years.

**RESIDENT COURSES ONLY**

Pre-Induction, Broadcast, Service, Aeronautical, Tele-  
vision and Marine telegraphy classes now forming for  
June 18. Literature upon request. Veteran training.

Home Study Course in Mathematics  
Dept. C., 38 West Biddle St., Baltimore 1, Md.

★ BUY AN ★

★ EXTRA ★

★ WAR BOND ★

dred thyratrons and a score of motors whirl into action. The sound is something like the chirping of frogs on a summer night. The blinking thyratrons add to the illusion.

The electrical brain can do a score of things at once. It can integrate simultane-ously as many as a dozen trying flight conditions and come up with the answers in a matter of seconds. Quicker than the human eye or brain, the thyratrons turn on motors to just the correct speed to simulate electrically one law of aerodynamics or a dozen if need be.

Such an electronic calculator, with different electrical constants interposed, can do a number of jobs. For instance, it might be arranged to predict the operation of a new airship before a single model is constructed, and do it solely from blueprints of the device. It might design a new locomotive, a new automobile engine, or a new washing machine. It might even be a boon for international yacht racers. Alfred Vanderbilt and a foremost British yachtsman, for instance, might run off a race with as much assurance of success for the best sailing master as if their vessels were competing within sight of each other just outside New York Harbor or off the Isle of Wight.

They might do this, even though neither had a vessel in the water, and had never seen each other across the 3000 or so miles of the Atlantic. All that would be required would be the creation of two such electrical

brains as the operational flight trainer—one in New York and another in London, with the respective yacht skippers operating the controls, which had been pre-set to simulate all the conditions of wind and wave. The skippers then might pit their skill against each other electronically by moving a series of dials designed to tack, run before the wind, round a buoy, jockey for position and a dozen or so other things in the science of yacht racing.

Radio engineers, however, would have to retire to their laboratories for another year to resolve the proper kind of aerodynamical equations and translate them into the elements of wind, wave and tide.

## MUSIC BY TELEVISION!

The first part of Dmitri Shostakovich's latest musical score—a composition for piano, violin and cello entitled "Trio"—has been flashed to New York directly from Moscow by radiophoto over the circuit of RCA Communications, Inc. prior to its American premiere. Hurdling wartime communication obstacles, the transmission is the first of its kind involving a major musical work and presages the speeding of compositions by the world's great musicians from one continent to another by radiophoto as soon as completed.

In actual transmission time, it took twenty-four minutes for the first page of the latest score to come from Moscow over the RCA receiving radiophoto machine. To facilitate handling, the photograph of the composition was sent in four sections of six by eight inches each, and these were cut into a mosaic of standard musical page size for the positive print.

## H-F TRANSMITTING TUBE



An interesting-looking tube, the new Eimac 4-215A, a power tetrode. Two tubes can put out as much as 750 watts in the VHF region.





He has mastered his craft. Each movement of his sure, deft hands adds Meissner quality to the precision electronic equipment he builds. Dedicated to the armed forces today, tomorrow his skills will mean Meissner precision-built products for you.

## MT. CARMEL HAS AN EYE TO THE FUTURE

"Personnel" is an outmoded word in the little city of Mt. Carmel, Ill. Why? Because it has been replaced by "precision-el," a word that more aptly describes the men and women whose skills and enthusiasm produce Meissner precision-built products for a world at war and who will soon help rebuild a world at peace.

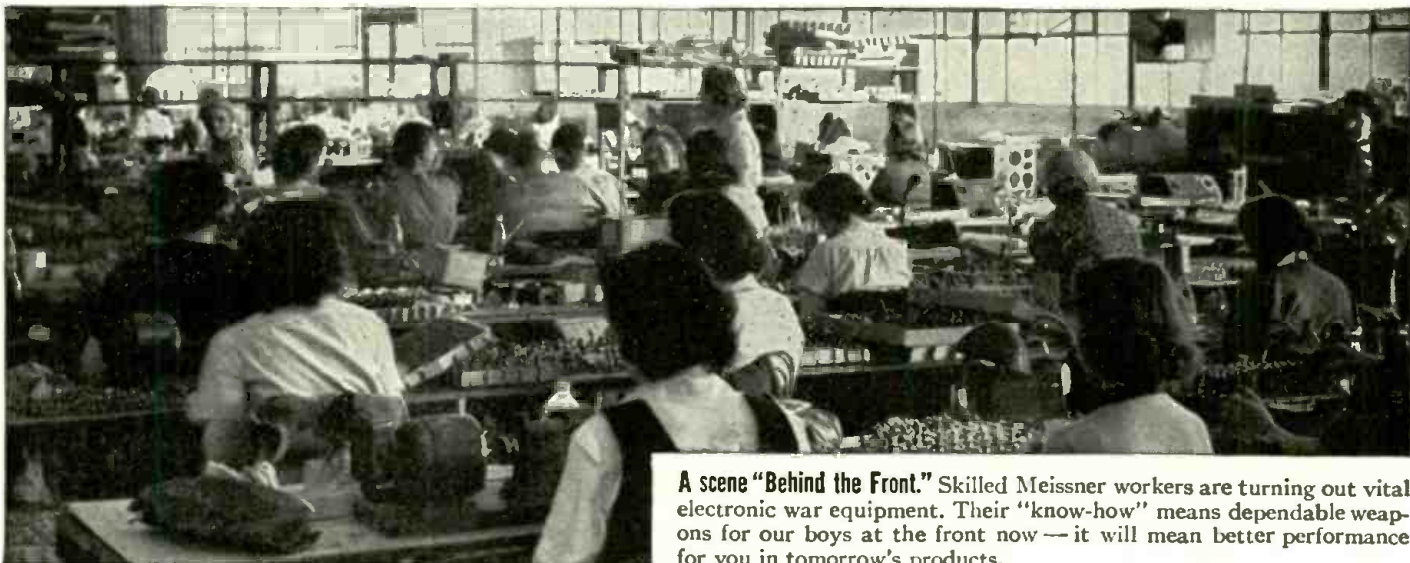

A scene "Behind the Front." Skilled Meissner workers are turning out vital electronic war equipment. Their "know-how" means dependable weapons for our boys at the front now — it will mean better performance for you in tomorrow's products.



They live in the future! Through their hands pass the work of Meissner's "precision-el," embodied in Meissner precision-built electronic equipment now going to our armed forces. Many of the parts they now handle as part of their daily routine will mean new comforts in postwar living.

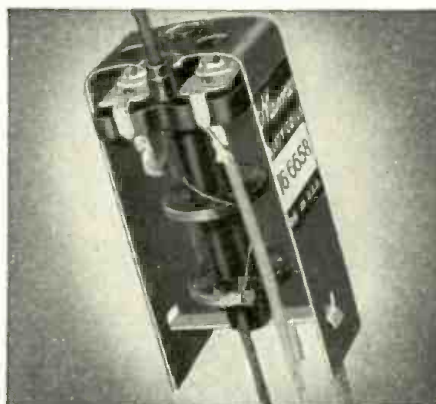

### "Step Up" Old Receivers!

These Meissner Ferrocart I. F. input and output transformers are getting top results in stepping up performance of old worn receivers. Special powdered iron core permits higher "Q" with a resultant increase in selectivity and gain, now available for frequency range 127-206. Ask for numbers 16-5728 input, 16-5730 output. List \$2.20 each.

# MEISSNER

MANUFACTURING COMPANY • MT. CARMEL, ILL.

ADVANCED ELECTRONIC RESEARCH AND MANUFACTURE  
Export Division: 25 Warren St., New York; Cable: Simontrice

*Just Published!*

# PANORAMIC'S

FASCINATING, NEW BOOK FOR AMATEUR RADIO OPERATORS!



## "From One Ham to Another"

Packed full of brand new information on amateur radio operation! Shows how you can solve many of your problems! Completely explains, in your own language, the PANORAMIC Technique, and what it will mean to you when you get back to your rig!

"From One Ham to Another" tells you how to get the most out of your rig. It shows you how you can have even more satisfactory QSO's with your friends all over the world. In detail it describes the problems that confront amateur radio operators... and proposes solutions. For example, after you have read "From One Ham to Another," you will know how to reduce the number of missed signals, how to determine quickly which frequencies are free, how to step up your efficiency.

Simple and pleasant to read, "From One Ham to Another" is written for the ham in terms you use. And you will be amused by the clever cartoons that illustrate it throughout. You will want to file and keep "From One Ham to Another" for the new ideas it provides. You will learn about the role that the PANADAPTOR will play in future ham operations. You'll be thrilled by the stories of wartime applications of this technique. Send for your free copy today!

"From One Ham to Another" discusses such subjects as:

- Watching for CQ's
- Answers to CQ's
- Operation of nets
- Choosing a spot in the band for your xmit
- Helping your brother ham
- Reading signal strength
- Logging the frequencies of your friends
- And many other topics of great interest

To obtain your free copy of "FROM ONE HAM TO ANOTHER," just send us a card with your name, address, and call letters if you have them. If you are now connected with radio in some way, we should like to know the name of the organization with which you are affiliated, and the type of work you do. EVEN IF YOU ARE NOT A HAM, YOU ARE WELCOME TO THIS PANORAMIC BOOK.

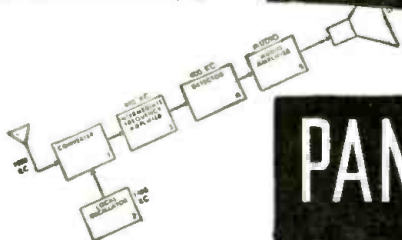
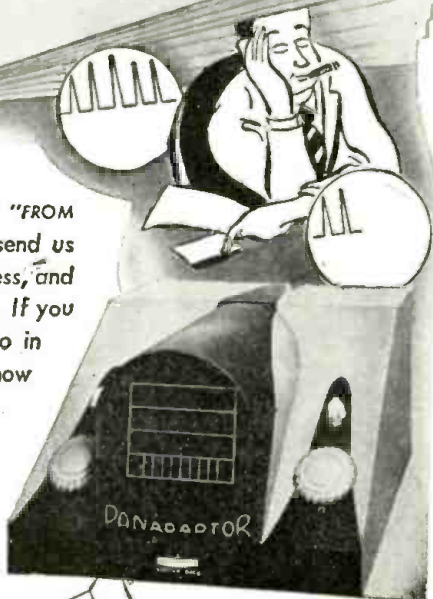

# PANORAMIC



# RADIO CORPORATION

242-250 WEST 55<sup>TH</sup> ST. New York 19, N.Y.

## A New Program of Mallory Standardization



P. R. MALLORY & CO., Inc., INDIANAPOLIS 6, INDIANA

# Here's Typical MALLORY Standardization!

**12 VIBRATORS MEET 90% OF  
YOUR REPLACEMENT NEEDS  
... 65 VIBRATORS REPLACE  
101 DIFFERENT TYPES**

Score another bull's eye for the Mallory program of standardization! Now the entire line of Mallory vibrators has been simplified so that replacements can be made more easily and quickly—with a *really streamlined stock* to select from!

This streamlining imposes no penalties. It means that the new list of 65 Mallory vibrators will answer the needs that formerly required 101 different types. Even more important, *90% of your replacement requirements can now be met with only 12 vibrators!*

Not least of the advantages of the new set-up is the fact that Mallory vibrators will be more readily

available. Because of the reduction in the number of vibrators, your distributor will stock fewer types—and more units of each! Delivery will be tremendously speeded up.

Yes, the replacement problem has been changed and simplified—but Mallory quality remains the same! Mallory precision vibrators, backed by years of outstanding performance, still offer the dependability, the long life and the trouble-free service that you and your customers expect from us.

Order them from your Mallory distributor. Ask him, too, for your copy of the new Mallory Vibrator Standardization Folder.

P. R. MALLORY & CO., Inc., INDIANAPOLIS 6, INDIANA



*More than ever—  
ALWAYS  
INSIST ON*

P. R. MALLORY & CO. Inc.  
**MALLORY**  
APPROVED  
PRECISION PRODUCTS

**VIBRATORS • VIBRAPACKS\* • CONDENSERS  
VOLUME CONTROLS • SWITCHES • RESISTORS  
FILTERS • RECTIFIERS • POWER SUPPLIES**

ALSO MALLORY "TROPICAL"™ DRY BATTERIES, ORIGINALLY DEVELOPED BY MALLORY FOR THE U. S. ARMY SIGNAL CORPS, NOT PRESENTLY AVAILABLE FOR CIVILIAN USE.

\*Trademarks

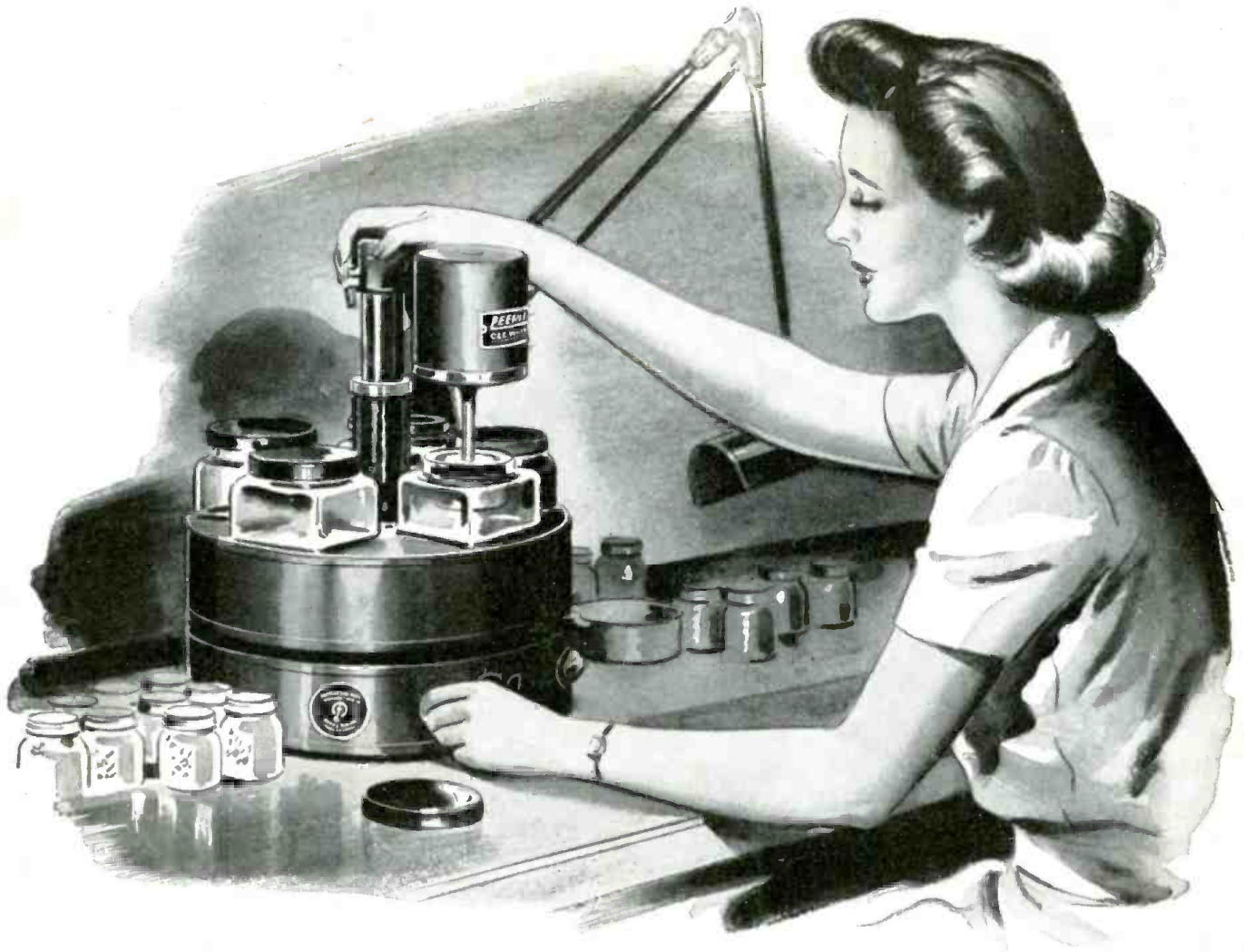

## EVERYDAY IS WASHDAY AT Triplet

• The special equipment and solutions with which jewels are washed are minor parts of the Triplet method of manufacturing fine electrical measuring instruments but they are significant. They typify the dozens of out-of-sight Extra Precautions that assure your permanent satisfaction with Triplet Instruments. These Extra Care provisions are routine in Triplet plants but through them Triplet maintains in mass production the hand-made quality of fine instruments.

*Extra Care in our work puts Extra Value in your Triplet Instrument.*



# Triplet



ELECTRICAL INSTRUMENT CO. BLUFFTON, OHIO

# ADV Plans, LLC

## Copyright Notice:

The entire contents of this CD/DVD are copyright 2014 by ADV Plans, LLC. All Rights Reserved.

Reproduction or distribution of this disk, either free or for a fee is strictly prohibited. We actively monitor and remove listings on eBay thru Vero.

You are free to copy or use individual images in your own projects, magazines, brochures or other school projects.

Only the sellers listed here are authorized distributors of this collection:  
[www.theclassicarchives.com/authorizedsuppliers](http://www.theclassicarchives.com/authorizedsuppliers)

Please view our other products at  
[www.theclassicarchives.com](http://www.theclassicarchives.com),  
or our ebay stores:

[TheClassicArchives](#)  
[ADVPlans](#)  
[SuperShedPlans](#)

